

SAMSUNG

E-MANUAL

Thank you for purchasing this Samsung product.
To receive more complete service, please register
your product at

www.samsung.com

Model _____ Serial No. _____

To directly go to the page that provides instructions
on how to use the manual for visually impaired
users, select the Menu Learning Screen link below.
[“Menu Learning Screen” Link](#)

Contents

Quick Guides

Using Smart Hub

Updating the TV's Software

- 9 Updating the TV's software to the latest version
- 9 Updating the TV automatically

Getting Support

- 10 Getting support through Remote Management
- 11 Finding the contact information for service
- 11 Requesting service

Connections

Connection Guide

Connecting an Antenna (Aerial)

Connecting to the Internet

- 14 Connecting to your Internet network
- 16 Checking the Internet connection status
- 16 Resetting Your Network
- 16 Turning on the TV with a Mobile Device
- 16 Connecting an IP control device to the TV
- 17 Setting up an Internet connection over IPv6
- 17 Changing the name of the TV on a network

Troubleshooting Internet Connectivity Issues

- 17 Troubleshooting Internet connectivity issues

Connecting Video Devices

- 19 Connecting with an HDMI cable
- 19 Connecting with a component cable
- 20 Connecting with a composite (A/V) cable
- 21 Connecting with a component cable (Only for models with COMPONENT IN / AV IN)
- 22 Connecting with a composite cable (Only for models with COMPONENT IN / AV IN)

Audio Input and Output Connections

- 23 Connecting with an HDMI (ARC) cable
- 23 Connecting with a digital audio (optical) cable
- 23 Connecting through a wireless network

Connecting a Computer

- 24 Connecting through the HDMI port — Screen Sharing (HDMI)

Connecting Your Mobile Device

- 25 Connecting to the TV via the SmartThings app
- 26 Bidirectionally mirroring your TV and mobile device using the SmartThings app
- 26 Managing a Mobile Device

Switching between external devices connected to the TV

- 27 Changing the input signal
- 27 Editing the name and icon of an external device
- 28 Using additional functions

Connection Notes

- 28 Connection notes for HDMI
- 29 Connection notes for audio devices
- 30 Connection notes for computers
- 30 Connection notes for mobile devices

Peripherals

Using Anynet+ (HDMI-CEC)

- 31 Connecting an external device through Anynet+ and using their menus

Controlling the TV with a Keyboard or Mouse

- 32 Connecting a USB keyboard or mouse
- 32 Using the keyboard and mouse
- 33 Setting up the input devices

Entering Text using the On-Screen Virtual Keyboard

Smart Features

Smart Hub

- 36 Displaying the Home Screen
- 40 Launching Smart Hub automatically
- 40 Launching the last used app automatically
- 40 Testing Smart Hub connections
- 40 Resetting Smart Hub

Using a Samsung account

- 41 Creating and managing your Samsung account
- 42 Signing in to a Samsung account

Using the Apps Service

- 45 Installing and running an app
- 46 Managing purchased or installed apps
- 47 Rating apps

Using the Gallery App

Using the Universal Guide App

Using the SmartThings App

Using the e-Manual

- 51 Launching the e-Manual
- 52 Using the buttons in the e-Manual

Using the Internet

Playing pictures/video/music

- 54 Playing media content

TV Viewing

Viewing Digital Broadcast Information at a Glance

- 55 Using the guide

Setting Up a Schedule Viewing

- 56 Setting up a schedule viewing for a channel
- 57 Editing a schedule viewing

Using the Channel List

Editing channels

- 59 Removing registered channels
- 59 Editing registered channels

Creating a Personal Favourites List

- 60 Registering channels as favourites
- 61 Viewing and selecting channels on Favourites lists only

Editing a Favourites List

- 61 Adding channels to favourites list
- 61 Removing channels from a favourites list
- 61 Rearranging a favourites list
- 61 Renaming a favourites list

TV-Viewing Support Functions

- 62 Changing the broadcast signal
- 62 Scanning for available channels
- 63 Checking digital channel signal info and strength
- 63 Restricting Viewing to Specific Channels
- 63 Using Mark Adult Channels
- 63 Selecting the broadcasting audio option
- 64 Using Programme Rating Lock
- 64 Configuring advanced broadcasting settings
- 64 Reading digital text
- 65 Selecting the broadcast audio language
- 65 Tuning broadcast signals manually
- 66 Fine-tuning analogue broadcasts
- 66 Transferring channel list
- 66 Enabling/Disabling Edit Channel Numbers
- 67 Deleting CAM operator profile
- 67 Setting satellite system
- 67 Changing teletext language
- 67 Showing TVkey Interface menu
- 68 Showing common interface menu

Picture and Sound

Adjusting the Picture Quality

- 69 Choosing a picture mode
- 70 Configuring advanced picture settings

Setting the Viewing Environment for External Devices

- 71 Playing games on an optimised screen
- 71 Using HDMI black level

Picture Support Functions

- 72 Changing the picture size
- 72 Changing the picture size automatically
- 72 Changing the picture size in 4:3 or Screen Fit mode
- 73 Fitting the picture to the screen
- 73 Adjusting the picture size and/or position

Configuring a Sound Mode and Expert Settings

- 73 Choosing a sound mode
- 74 Configuring advanced sound settings

Using the Sound Support Functions

- 75 Selecting speakers
- 75 Listening to the TV through a Samsung audio device that supports the Wi-Fi function

System and Support

Using the Time Functions and the Timers

- 76 Setting the current time
- 77 Using the timers

Using the Auto Protection Time and Energy Saving Functions

- 78 Setting the Auto Protection Time
- 78 Reducing the energy consumption of the TV

Updating the TV's Software

- 79 Updating the TV's software to the latest version
- 79 Updating the TV automatically

Protecting the TV from Hacking and Malicious Code

- 80 Scanning the TV and connected storage for malicious code

Using Other Functions

- 80 Running the accessibility functions
- 80 Running Accessibility Shortcuts
- 81 Enabling voice guides for the visually impaired
- 81 Audio Description
- 82 White text on black background (high contrast)
- 82 Enlarging the font (for the visually impaired)
- 82 Learning about the remote control (for the visually impaired)
- 82 Learning about the TV menu
- 83 Watching TV broadcasts with subtitles
- 83 Configuring advanced system settings
- 84 Restoring the TV to the factory settings

HbbTV

Using a TV Viewing Card ("CI or CI+ Card")

- 86 Connecting the "CI or CI+ Card" via COMMON INTERFACE slot with the CI CARD Adapter
- 87 Connecting the "CI or CI+ Card" via COMMON INTERFACE slot
- 87 Using the "CI or CI+ Card"

Teletext Feature

- 90 Typical Teletext page

Troubleshooting

Getting Support

- 91 Getting support through Remote Management
- 92 Finding the contact information for service
- 92 Requesting service

Diagnosing TV operational issues

There Is a Problem with the Picture

- 93 Testing the picture

I Can't Hear the Sound Clearly

- 96 Testing the sound

There Is a Problem with the Broadcast

My Computer Won't Connect

The TV Won't Connect to the Internet

Anynet+ (HDMI-CEC) Isn't Working

I Have Trouble Launching/Using Apps

My File Won't Play

I Want to Reset the TV

Other Issues

Precautions and Notes

Supported broadcasting audio options

Read Before Using Apps

Read Before Using the Internet

- 107 Read before setting up a wireless Internet connection

Read Before Playing Photo, Video, or Music Files

- 108 Limitations on use of photo, video, and music files
- 109 Supported external subtitles
- 109 Supported internal subtitles
- 110 Supported image formats and resolutions
- 110 Supported music formats and codecs
- 111 Supported video codecs

Read After Installing the TV

- 113 Picture sizes and input signals
- 113 Installing an anti-theft lock

Read Before Connecting a Computer (Supported Resolutions)

- 114 Full HD TV
- 114 IBM
- 114 MAC
- 115 VESA DMT
- 116 HD TV
- 116 IBM
- 116 MAC
- 117 VESA DMT

Supported Resolutions for Video Signals

- 118 VESA CVT
- 118 CEA-861

Buttons and functions available while playing multimedia content

Licences & Other Information

Accessibility Guidance

Menu Learning Screen

Using the accessibility menu

- 122 Accessibility Shortcuts menu
- 123 Step by Step instructions to run the options

Using the TV with Voice Guide on

- 125 Watching TV

Using the guide

Setting Up a Schedule Viewing

- 129 Cancelling a scheduled viewing

Using the Channel List

- 131 Creating a Personal Favourites List

Using Smart Hub

- 133 Smart Hub
- 134 Using the Home Screen in Smart Hub

Launching the e-Manual

Quick Guides

You can learn quickly how to run and use the frequently used functions.

Using Smart Hub

Connect to Smart Hub for apps, games, movies, and more.

Enjoy the multiple functions provided by **Smart Hub** simultaneously on a single screen.

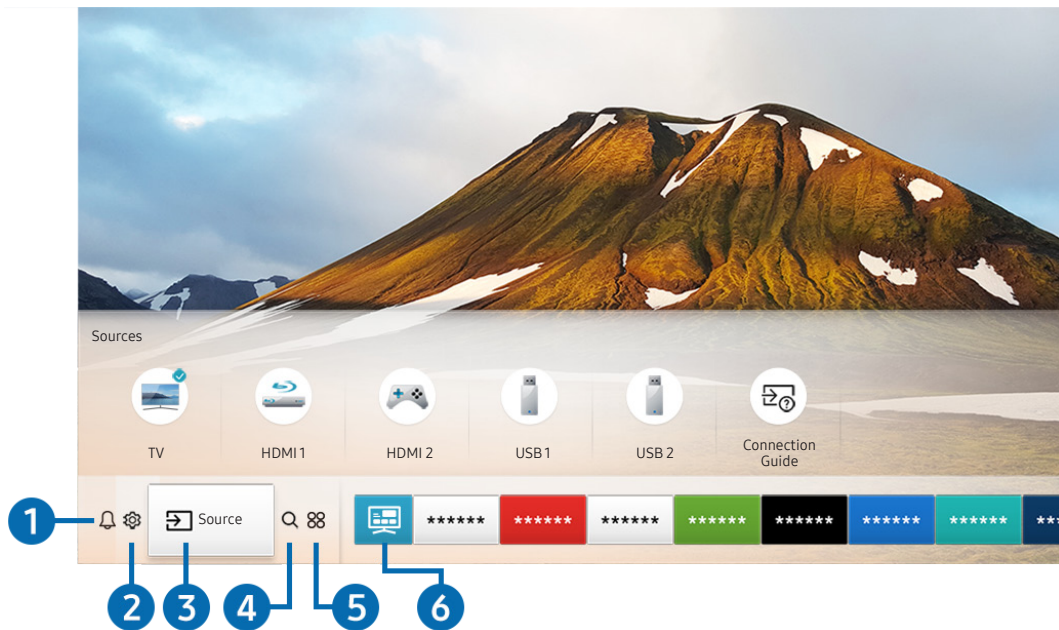

 The image on your TV may differ from the image above depending on the model and geographical area.

When you press the  button on your remote control, you can use the following functions and features.

1 Notification

You can view a list of notifications for all events that occur on your TV. A notification appears on the screen when it is time to broadcast a scheduled programme or when an event occurs on a registered device.

 For more information, refer to "[Displaying the Home Screen](#)".

2 Settings

When the focus is moved to the  icon, a list of quick settings icons appears above the top of the menu. You can quickly set frequently used functions by clicking the icons.

3 Source

You can select an external device connected to the TV.

 For more information, refer to "[Switching between external devices connected to the TV](#)".

4 Search

You can search for channels, programmes, movie titles, and apps from Smart Hub.

 To use this feature, the TV must be connected to the Internet.

5 APPS

You can enjoy a wide range of content including news, sports, weather, and games by installing the corresponding apps on your TV.

 To use this feature, the TV must be connected to the Internet.

 For more information, refer to "[Using the Apps Service](#)".

6 Universal Guide

Universal Guide is an app that allows you to search for and enjoy various content such as TV shows, dramas, and movies in one place. **Universal Guide** can recommend content tailored to your preferences and notify you of new drama series.

 For more information about the **Universal Guide**, refer to "[Using the Universal Guide App](#)".

 Images may look blurry depending on the service provider's circumstances.

 This function may not be supported depending on the model or geographical area.

Updating the TV's Software

View your TV's software version and update it if necessary.

[Home](#) > [Settings](#) > [Support](#) > [Software Update](#) [Try Now](#)

Updating the TV's software to the latest version

⚠ DO NOT turn off the TV's power until the update is complete. The TV will turn off and on automatically after completing the software update. Video and audio settings will be reset to their defaults after a software update.

Updating through the Internet

[Home](#) > [Settings](#) > [Support](#) > [Software Update](#) > [Update Now](#) [Try Now](#)

 Updating from the Internet requires an active Internet connection.

Updating through a USB device

[Home](#) > [Settings](#) > [Support](#) > [Software Update](#) > [Update Now](#)

After downloading the update file from the Samsung website and storing it on a USB device, connect the USB device to the TV to update.

 To update using a USB flash drive, download the update package from Samsung.com to your computer. Then, save the update package in the USB device's top-level folder. Otherwise, the TV will not be able to locate the update package.

Updating the TV automatically

[Home](#) > [Settings](#) > [Support](#) > [Software Update](#) > [Auto update](#) [Try Now](#)

If the TV is connected to the Internet, you can have the TV update its software automatically while you are watching the TV. When the background update is completed, it is applied the next time the TV is turned on.

If you agree to the Smart Hub terms and conditions, **Auto update** is set to **On** automatically. If you want this function disabled, use the Select button to turn it off.

 This function may take a longer time if another network function is running concurrently.

 This function requires an Internet connection.

Getting Support

Get help directly from Samsung if you have a problem with your TV.

Getting support through Remote Management

[Home](#) > [Settings](#) > [Support](#) > [Remote Management](#) [Try Now](#)

After consenting to our service agreement, you can use [Remote Management](#) to access Remote Support and have a Samsung service technician diagnose your TV, correct problems, and update your TV's software remotely via the web. You can also turn [Remote Management](#) on and off.

 This function requires an Internet connection.

 You can also start this function by pressing and holding the [Home](#) button for 5 or more seconds.

What is Remote Support?

Samsung Remote Support service offers you one-on-one support with a Samsung Technician who can remotely:

- Diagnose your TV
- Adjust the TV settings for you
- Perform a factory reset on your TV
- Install recommended firmware updates

How does Remote Support Work?



You can easily get Samsung Remote Support service for your TV:

1. Call the Samsung Contact Centre and ask for remote support.
2. Open the menu on your TV and go to the [Support](#) section. ([Home](#) > [Settings](#) > [Support](#))
3. Select [Remote Management](#), then read and agree to the service agreements. When the PIN screen appears, provide the PIN number to the technician.
4. The technician will then access your TV.

Finding the contact information for service

 >  [Settings](#) > [Support](#) > [About This TV](#) 



You can view the address of the Samsung website, the call centre phone number, your TV's model number, your TV's software version, Open Source Licence and other information you may need to get service support from a Samsung call agent or the Samsung website.

-  You can also view information by scanning the QR code of your TV.
-  You can also start this function by pressing and holding the  (Play) button for 5 or more seconds. Continue holding the button until the customer information pop-up window appears.

Requesting service

 >  [Settings](#) > [Support](#) > [Request Support](#) 

You can request service when you encounter a problem with the TV. Select the item matching the problem that you encountered, and then select [Request Now](#) or [Schedule Appointment](#) > [Request](#) > [Send](#). Your service request will be registered. The Samsung Contact Centre will contact you to set up or confirm your service appointment.

-  This function may not be supported depending on the geographical area.
-  You must agree to the terms and conditions for the service request.
-  This function requires an Internet connection.

Connections

You can watch live broadcasts by connecting an antenna and antenna cable to your TV and can get access to the Internet by using a LAN cable or wireless router. Using various connectors, you can also connect external devices.

Connection Guide

You can view detailed information about external devices that can be connected to the TV.

[Home](#) > [Source](#) > [Connection Guide](#)

It guides you the way to connect various external devices such as the cable box, game console, and PC through pictures. If you select the connection method to an external device, the information details appear.

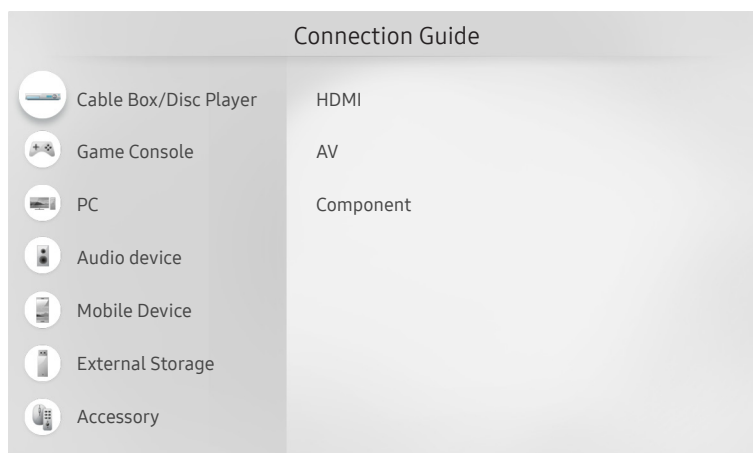

 The image on your TV may differ from the image above depending on the model and geographical area.



Connecting an Antenna (Aerial)

You can connect an antenna cable to your TV.

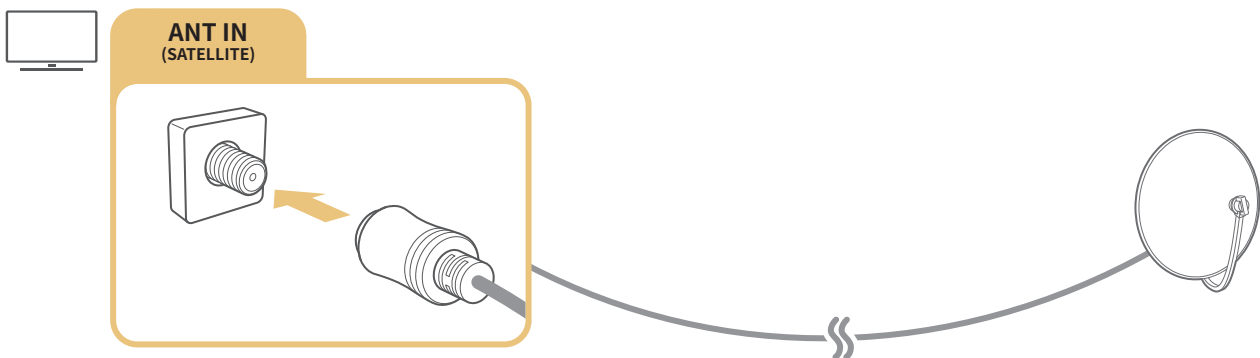
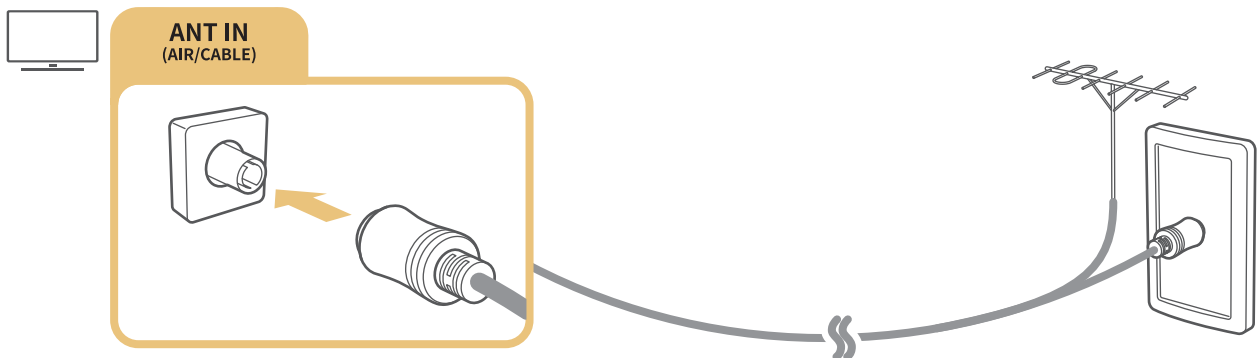
 An antenna connection is not necessary if you connect a cable box or satellite box.



It is best to connect the both connectors using a Multi-Switch or DiSEqC. Switch, etc and to set **Aerial Connection Type** to **Dual Oscillator**.

-  A connection method may differ with the models.
-  The DVB-T2 system may not be supported depending on the geographical area.
-  Depending on the model or geographical area.

Connecting to the Internet

You can get access to the Internet through your TV.

Connecting to your Internet network

[Home](#) > [Settings](#) > [General](#) > [Network](#) > [Open Network Settings](#) [Try Now](#)

Connect to an available network.

Establishing a wired Internet connection

[Home](#) > [Settings](#) > [General](#) > [Network](#) > [Open Network Settings](#) > [Wired](#)

If you connect a LAN cable, the TV automatically accesses the Internet.

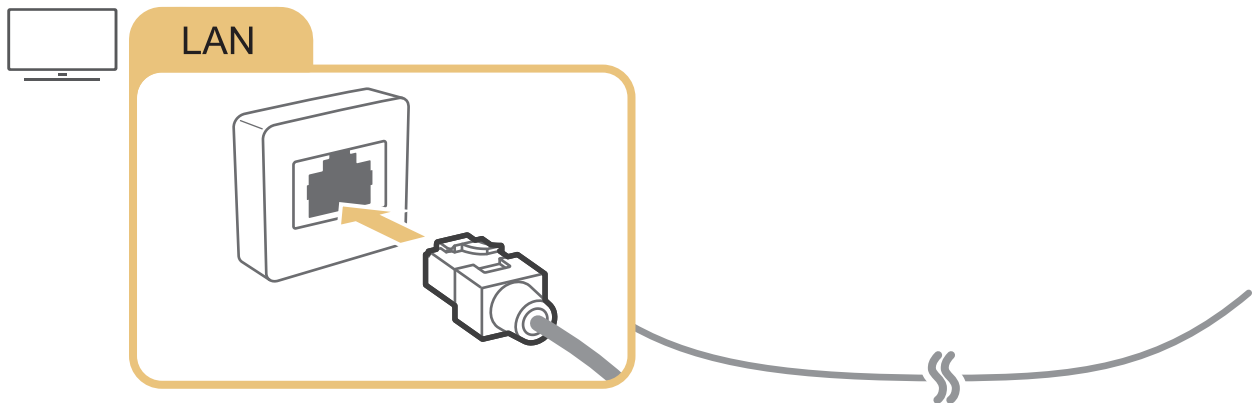

 Use a CAT7 (*STP type) cable for the connection.
* Shielded Twist Pair

 The TV will not be able to connect to the Internet if your network speed is below 10 Mbps.

Establishing a wireless Internet connection

🏠 > ⚙️ **Settings** > **General** > **Network** > **Open Network Settings** > **Wireless**

Make sure that you have the wireless router's SSID (name) and password settings before attempting to connect. The network name (SSID) and security key are available on the wireless router's configuration screen. See the wireless router's user manual for more information.

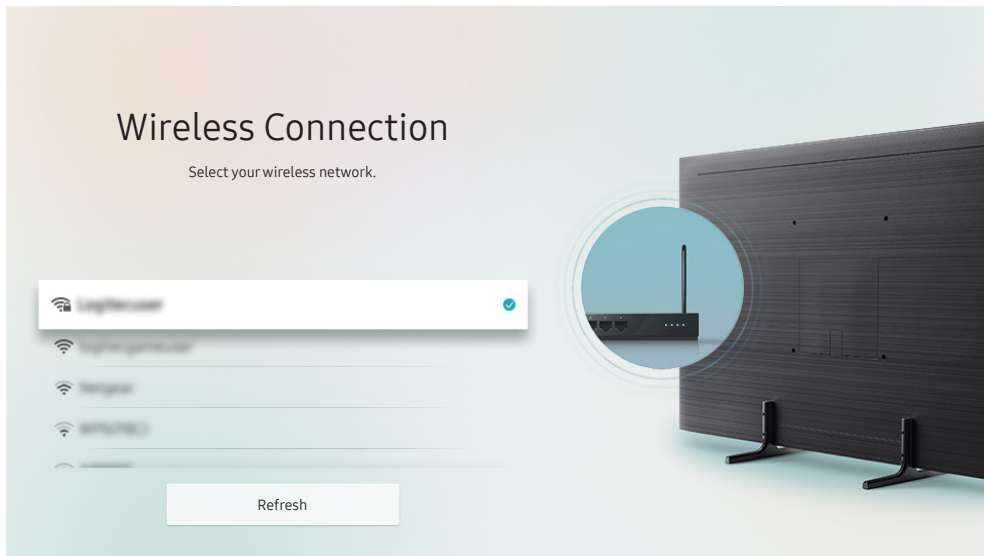
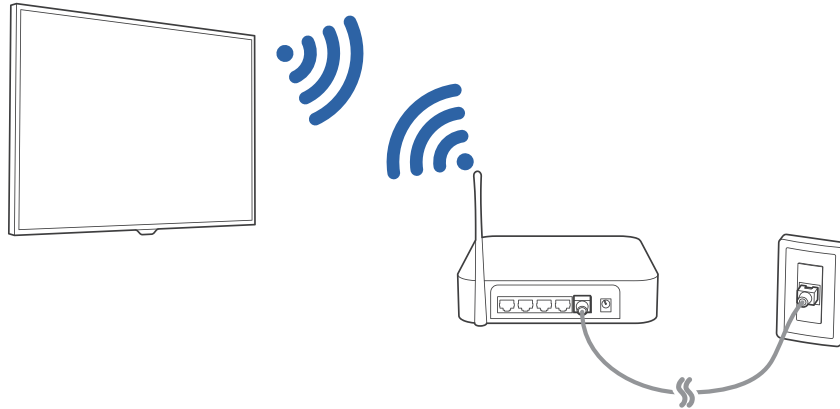

- ✎ The image on your TV may differ from the image above depending on the model and geographical area.
- ✎ If no wireless router is found, select **Add Network** at the bottom of the list and enter the network name (SSID).
- ✎ If your wireless router has a WPS or PBC button, select **Use WPS** at the bottom of the list, and then push the WPS or PBC button on your router within 2 minutes. The TV will connect automatically.

Checking the Internet connection status

[Home](#) > [Settings](#) > [General](#) > [Network](#) > [Network Status](#) [Try Now](#)

View the current network and Internet status.

Resetting Your Network

[Home](#) > [Settings](#) > [General](#) > [Network](#) > [Reset Network](#) [Try Now](#)

Restore the network settings to the factory defaults.

Turning on the TV with a Mobile Device



[Home](#) > [Settings](#) > [General](#) > [Network](#) > [Expert Settings](#) > [Power On with Mobile](#)

You can turn on the TV with your mobile device when both of them are connected to the same network.

Connecting an IP control device to the TV

[Home](#) > [Settings](#) > [General](#) > [Network](#) > [Expert Settings](#) > [IP Remote](#)

You can connect an IP control device to the TV remotely to manage your IP device.

-  To use this function, [Power On with Mobile](#) must be turned on.
-  Turning this feature on may allow other IP control devices to control your TV. We recommend turning this feature on only if an authorised third-party custom controller is installed and configured specifically for a Samsung TV and if your Wi-Fi network is password protected.
-  This function may not be supported depending on the model or geographical area.

Setting up an Internet connection over IPv6

Configuring the IPv6 connection settings

[Home](#) > [Settings](#) > [General](#) > [Network](#) > [Expert Settings](#) > [IPv6](#)

 This function may not be supported depending on the model or geographical area.

Checking an Internet connection set up over IPv6

[Home](#) > [Settings](#) > [General](#) > [Network](#) > [Expert Settings](#) > [IPv6 Status](#)

 This function may not be supported depending on the model or geographical area.

Changing the name of the TV on a network

[Home](#) > [Settings](#) > [General](#) > [System Manager](#) > [Device Name](#) [Try Now](#)

You can change the name of the TV on the network. Select [User Input](#) at the bottom of the list and change the name.

Troubleshooting Internet Connectivity Issues

If your TV won't connect to the Internet, try the solutions below.

Troubleshooting Internet connectivity issues [Try Now](#)

After reading the following content, troubleshoot the Internet connection issue. If the problem persists, contact your Internet Service Provider.

No network cable found

Make sure that the LAN cable is plugged in on both ends. If it is plugged in, make sure that the router is turned on. If the router is on, try turning it off and then on.

Wireless network connection failed

If a selected wireless router is not found, go to [Open Network Settings](#), and then select the correct router.

- [Home](#) > [Settings](#) > [General](#) > [Network](#) > [Open Network Settings](#)

Unable to connect to a wireless router

1. Check if the router is turned on. If it is, turn it off and then on.
2. Enter the correct password if required.

IP auto setting failed

1. Configure the settings in [IP Settings](#).
 - [Home](#) > [Settings](#) > [General](#) > [Network](#) > [Network Status](#) > [IP Settings](#)
2. Make sure that the DHCP server is enabled on the router, and then unplug the router and plug it back in.
3. Reset the router if required.
 - For wireless connection, enter the correct password if required.

Unable to connect to the network

1. Check all [IP Settings](#).
 - [Home](#) > [Settings](#) > [General](#) > [Network](#) > [Network Status](#) > [IP Settings](#)
2. After checking the DHCP server status (must be active) on the router, remove the LAN cable, and then connect it again.
 - For wireless connection, enter the correct password if required.

Connected to a local network, but not to the Internet

1. Make sure that the Internet LAN cable is connected to the router's external LAN port.
2. Check the DNS values in [IP Settings](#).
 - [Home](#) > [Settings](#) > [General](#) > [Network](#) > [Network Status](#) > [IP Settings](#)

Network setup is complete, but unable to connect to the Internet

If the problem persists, contact your Internet Service Provider.

Connecting Video Devices

Make the correct video connections between your TV and your external devices.

Connecting with an HDMI cable

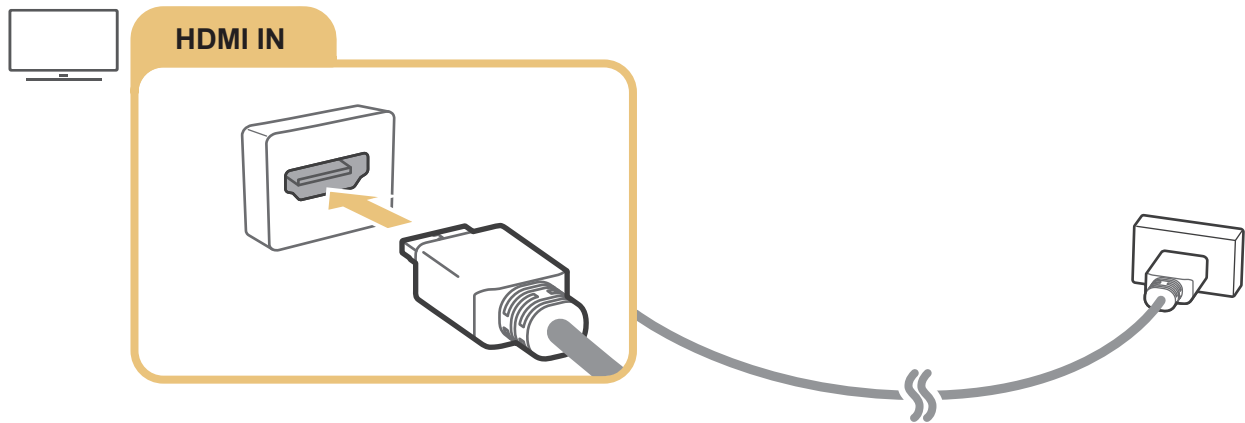

Connecting with a component cable

Connect the component cable to the component input connectors of the TV and the component output connectors of the device as shown in the image below.

Make sure the cable colours match the connector colours.

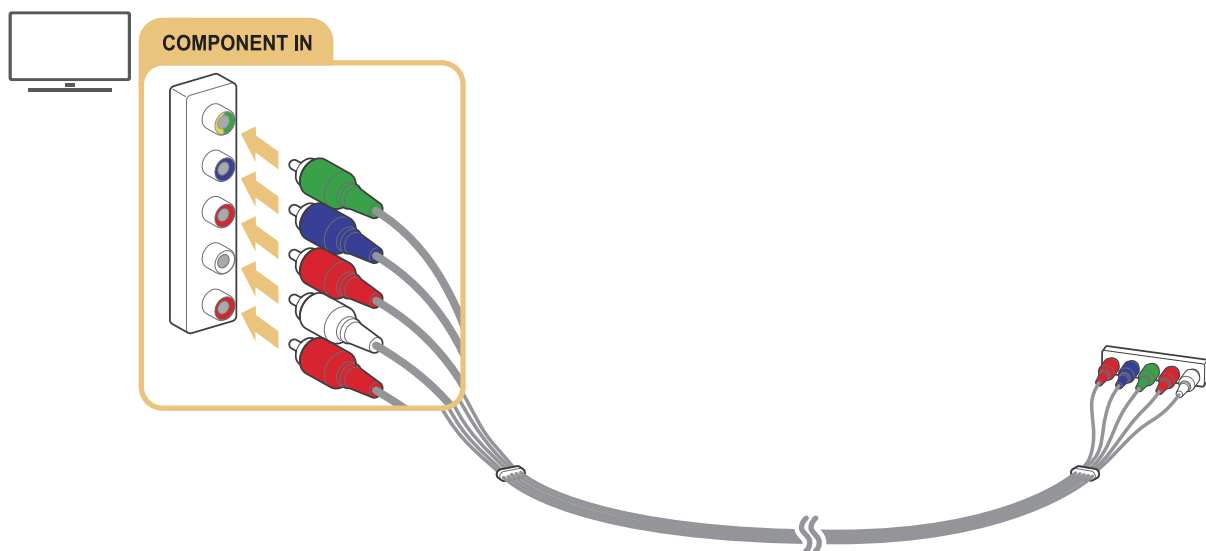

 Depending on the model or geographical area.

Connecting with a composite (A/V) cable

Connect the AV cable to the AV input connectors of the TV and the AV output connectors of the device as shown in the image below.

Make sure the cable colours match the connector colours.

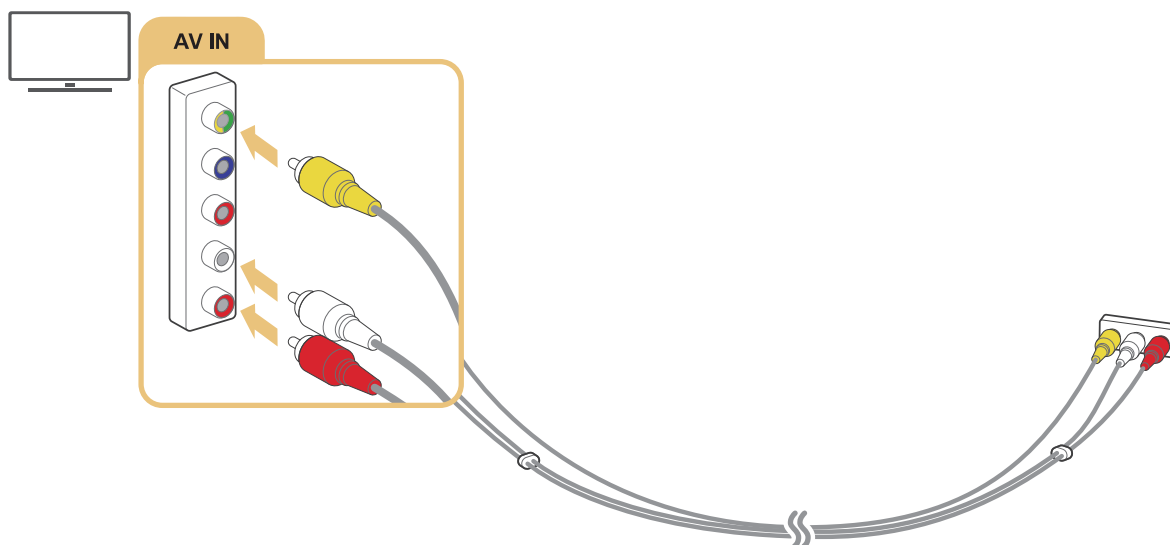

 Depending on the model or geographical area.

Connecting with a component cable (Only for models with COMPONENT IN / AV IN)

A Component connection lets you enjoy video resolutions up to 1080p. To watch video from most DVD and Blu-ray players, use the Component connection.

Review the illustration below, and then connect Component IN and AV IN on the TV to Component OUT on the external device by using the provided component and AV adaptors. Make sure to connect the same colour connectors together. (blue to blue, yellow to yellow, etc.)

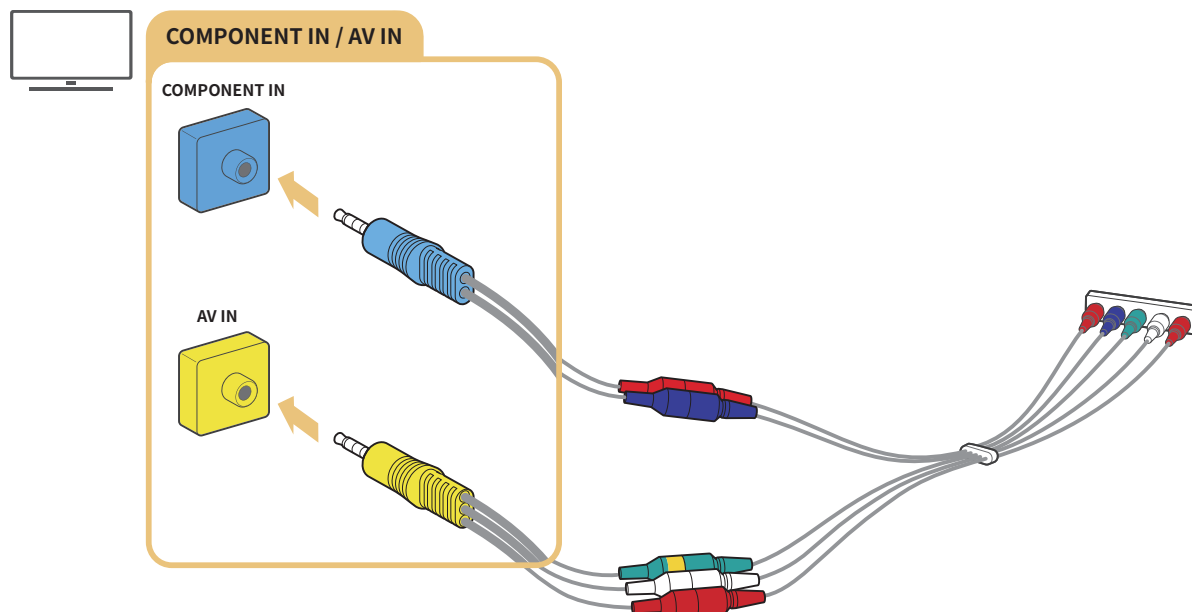

 To use component equipment, connect both the component adaptor (blue) and the AV adaptor (yellow).



 Depending on the model or geographical area.

Connecting with a composite cable (Only for models with COMPONENT IN / AV IN)

Through the AV connection, you can enjoy the resolution up to 576i.

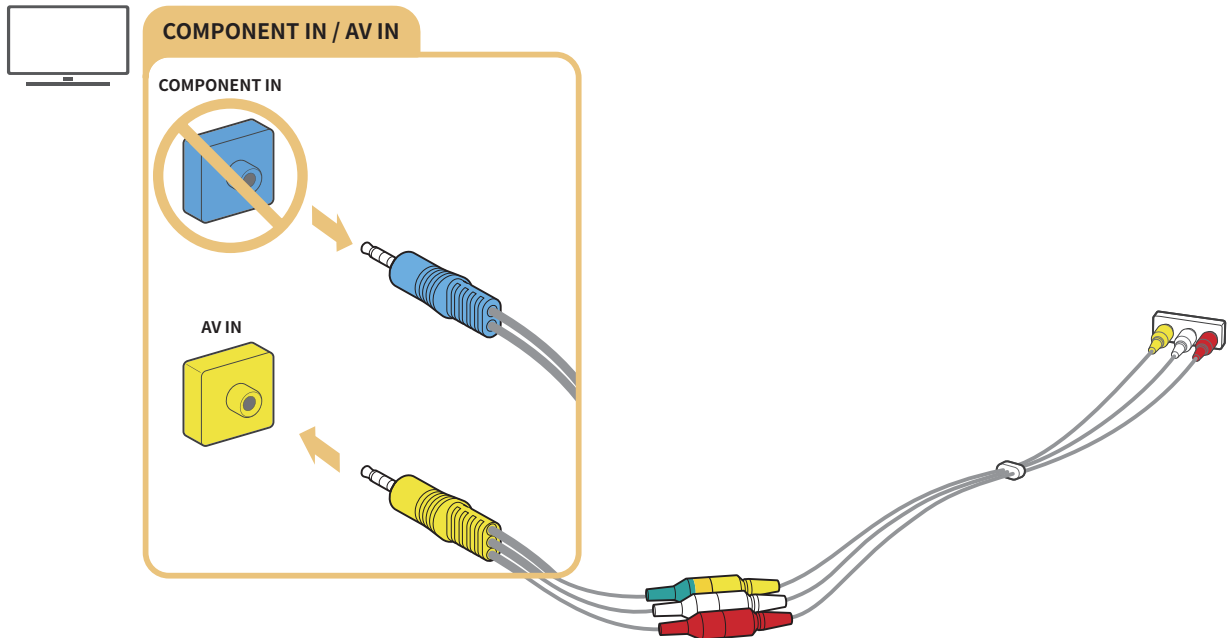
Review the illustration below, and then connect AV IN on the TV to AV OUT on the external device by using the provided composite cable and AV adaptor. When connecting the cables, be sure to match the colours of the cables to the colours of the ports.



-  Connect AV (composite) equipment to AV In only. Do not connect to Component In.
-  Depending on the model or geographical area.

Audio Input and Output Connections

Make the correct audio connections between your TV and your external devices.

 For more information about how to select external speakers, refer to "[Selecting speakers](#)".

Connecting with an HDMI (ARC) cable

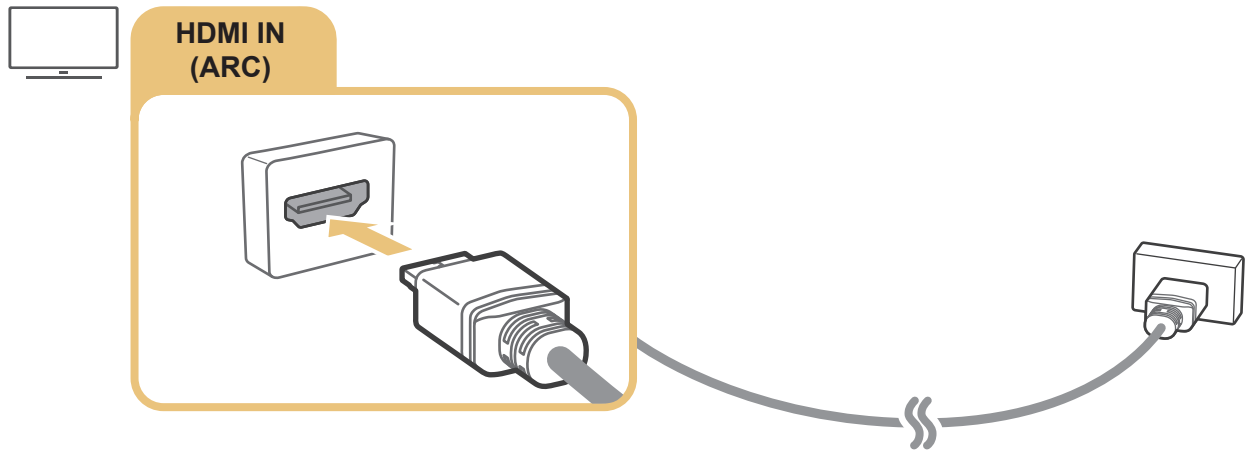

Connecting with a digital audio (optical) cable

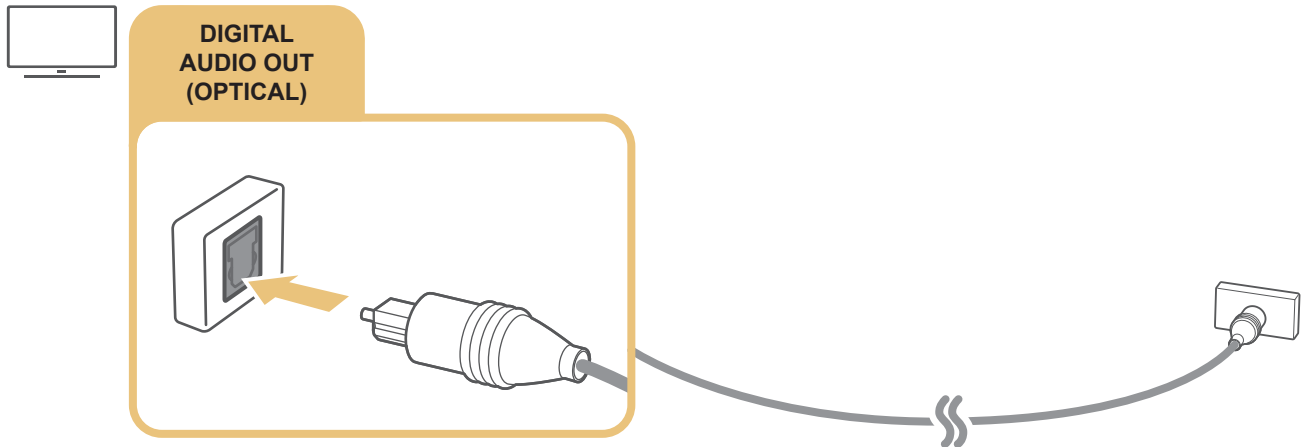

Connecting through a wireless network



You can connect the TV to a Samsung audio device that supports the Wi-Fi function through your wireless network. The two devices must be connected to the same network. For more information about how to connect and use a Samsung audio device that supports the Wi-Fi function, refer to its user manual.

Connecting a Computer

Use the TV as a computer monitor or connect the TV to a computer via your network and access the computer's content.

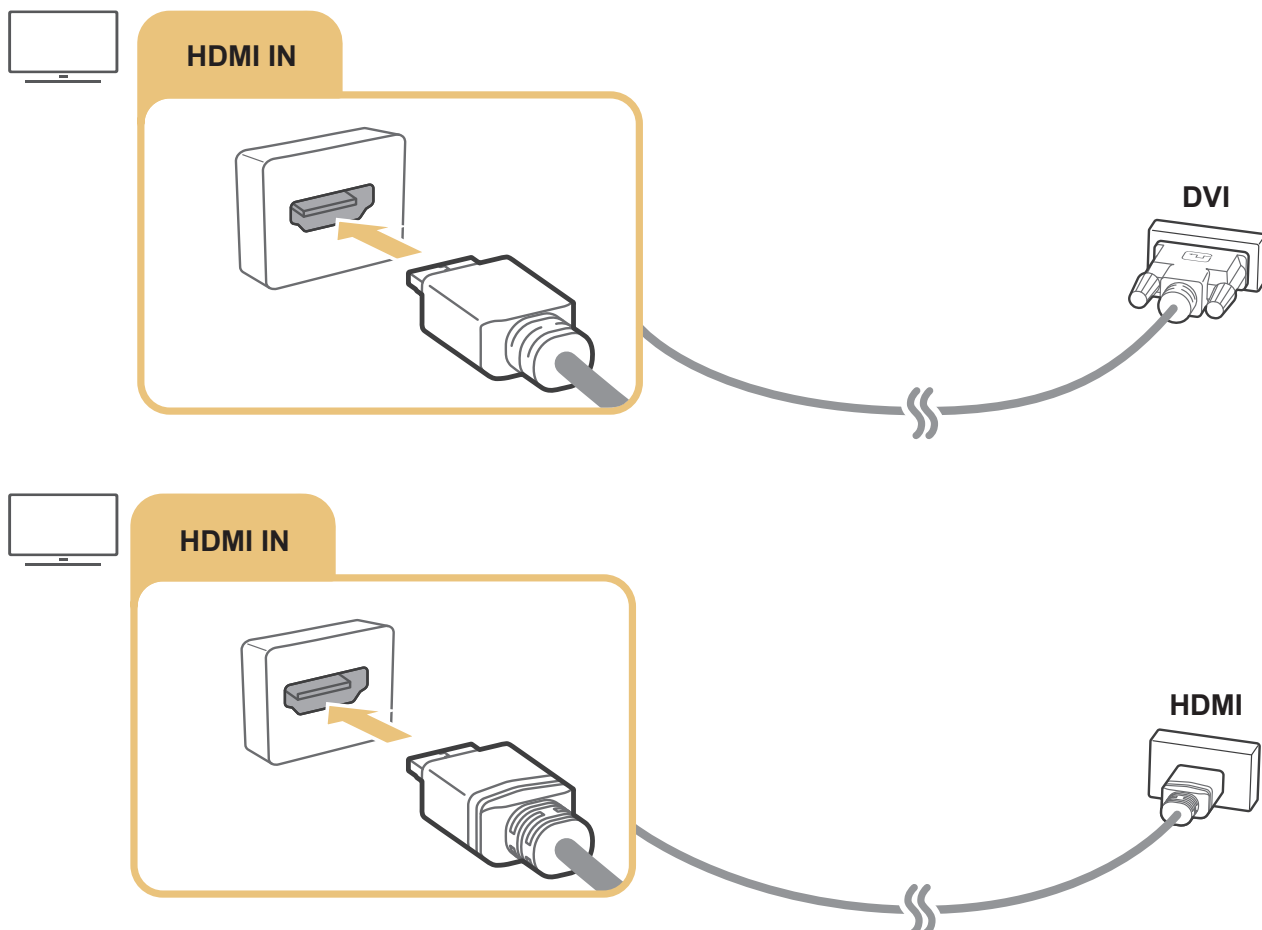
Connecting through the HDMI port — Screen Sharing (HDMI)







 When you have connected a PC, go to  >  [Source](#), and then select the PC icon from the external device icon list. For more information about the port settings, refer to "[Editing the name and icon of an external device](#)".

Connecting Your Mobile Device

Connect your mobile device to the TV on the same network to control the TV with the mobile device or enjoy the content of the mobile device on the TV.

Use the SmartThings app on your mobile device to quickly and easily connect to the TV and control its main settings. In addition, you can remotely check and control the statuses of various devices such as Samsung smart devices, home appliances, and speakers registered to the server.





-  Make sure that your TV supports SmartThings. You can check it with the **Supported Devices** menu in the SmartThings app.
-  To use the SmartThings app, you must be signed in to your Samsung account on the TV.
-  This function may not be supported depending on the TV model or mobile device.
-  This function may not be supported depending on the model or geographical area.
-  The supported functions may differ depending on the version of the SmartThings app.

You can install the SmartThings app from App Store or Google Play Store.

Connecting to the TV via the SmartThings app

1. Turn on the TV.
2. Start the SmartThings app on your mobile device.
3. Tap **Add Device** on the dashboard of the SmartThings app. Connectable TVs are searched for.
4. From the search results, select the model of your TV.
5. Enter the PIN number displayed on the TV screen.

Once the TV is registered with your Samsung account, you can use the SmartThings app to control the TV.

-  This function may not be supported depending on the model or geographical area.
-  If your TV is not found on your mobile device, turn both of them off and on, and then try again.
-  If you have more than one TV, you can easily select the TV you want by setting different TV names at  >  **Settings** > **General** > **System Manager** > **Device Name**.

Bidirectionally mirroring your TV and mobile device using the SmartThings app

Bidirectional mirroring refers to either outputting the same screen and sound of a mobile device on a TV or outputting the same screen and sound of a TV on a mobile device. You can use the SmartThings app to enjoy the screen and sound of the TV on your mobile device or to play the screen and sound of your mobile device on the TV.

Start the SmartThings app on your mobile device. Tap your TV from the dashboard or device. You can use the following functions:

- You can enjoy the screen and sound of the mobile device on your TV.



After you connect a mobile device that supports screen mirroring to your TV, you can use screen mirroring to enjoy the screen and sound of the mobile device on your TV wirelessly and play the video, audio, or photo files currently playing on the mobile device on your TV.

- You can enjoy TV screen and sound on your mobile device.
- You can only listen to the TV sound on your mobile device.



This function may not be supported depending on the model or geographical area.



You can add a new device through the SmartThings app on your mobile phone. Please refer to the user guide in the SmartThings app for more details.



This function may not be supported depending on the TV model or mobile device.



The supported functions may differ depending on the version of the SmartThings app.



If there is no TV found, try again after turning both off and on.



If you have multiple TVs, assign a different name to each TV in [Home](#) > [Settings](#) > [General](#) > [System Manager](#) > [Device Name](#) to make selection easy.

Managing a Mobile Device

[Home](#) > [Settings](#) > [General](#) > [External Device Manager](#) > [Device Connection Manager](#) [Try Now](#)

- [Access Notification](#)

Set whether to display a notification when a mobile device attempts to connect to the TV.

- [Device List](#)

View, edit, or remove a list of mobile devices registered to the TV.

Switching between external devices connected to the TV

You can switch between TV programmes and the content of external devices.

Changing the input signal

Home > Source

When you select a connected external device on the **Source** screen, the output of the selected device is displayed on the TV's screen.

 When a USB device is connected to the USB port, a pop-up message appears that lets you switch easily to the media content listed on the device.

 This function may not be supported depending on the device and geographical area.

Editing the name and icon of an external device

Home > Source

You can change the port name for a connected external device or add it to Home Screen.

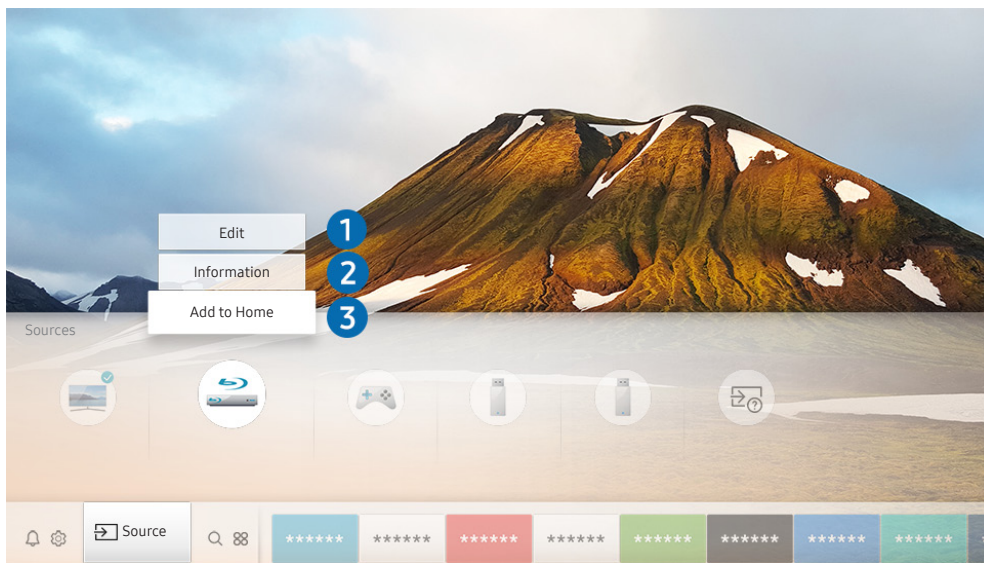

 The image on your TV may differ from the image above depending on the model and geographical area.

1. Move the focus to a connected external device.
2. Press the Up directional button. The following functions become available.

 Available functions may differ depending on the port type.

1 Edit

You can rename the input ports and change the device icons.

2 Information

You can view the detailed information about the external devices connected to the TV.

3 Add to Home

You can add the port of an external device to the Home Screen for quick switching.



Using additional functions

You can use the following features on the [Source](#) screen.

- [Connection Guide](#): The guide to device connections.

Connection Notes

When connecting an external device, note the following.

-  The number of connectors and their names and locations may differ with the model.
-  Refer to the external device's operating manual when connecting it to the TV. The number of external device connectors and their names and locations may differ with the manufacturer.

Connection notes for HDMI

- The following types of HDMI cables are recommended:
 - High-Speed HDMI Cable
 - High-Speed HDMI Cable with Ethernet
- Use an HDMI cable with a thickness of 0.66 inches (17 mm) or less.

- Using a non-certified HDMI cable may result in a blank screen or a connection error.
- Some HDMI cables and devices may not be compatible with the TV due to different HDMI specifications.
- This TV does not support HDMI Ethernet Channel. Ethernet is a Local Area Network (LAN) built with coaxial cables standardised by the IEEE.
- Many computer graphics adaptors do not have HDMI ports, but have DVI ports instead. If your PC does not support HDMI video out, connect your PC with an HDMI-DVI cable.

Connection notes for audio devices

- For better audio quality, it is a good idea to use an AV receiver.
- If you connect an external audio device using an optical cable, the **Sound Output** setting is automatically changed to the connected device. However, to make this happen, you must turn on the external audio device before connecting the optical cable. To manually change the **Sound Output** setting, do one of the following:
 - Use the **Quick Settings** screen to change to the connected device:
Use the Select button to select **Audio Out/Optical** on the **Sound Output** menu. (🏠 > ⚙️ **Settings** > up directional button > **Sound Output**).
 - Use the **Settings** screen to change to the connected device:
Select **Audio Out/Optical** on the **Sound Output** menu. (🏠 > ⚙️ **Settings** > **Sound** > **Sound Output**).
- An unusual noise coming from a connected audio device while you are using it may indicate a problem with the audio device itself. If this occurs, ask for assistance from the audio device's manufacturer.
- Digital audio is only available with 5.1 channel broadcasts.

Connection notes for computers

- For the resolutions supported by the TV, refer to "[Read Before Connecting a Computer \(Supported Resolutions\)](#)".
- As long as file sharing is activated, unauthorised access may occur. When you do not need to access data, disable file sharing.
- If you want to connect your PC and TV wirelessly, both of them must be connected to each other on the same network.
- When sharing content with other network-based devices such as those in an IP (Internet Protocol) storage system, sharing may not be supported due to the network's configuration, quality, or functionality, for example, if the network has an NAS (Network-Attached Storage) device.

Connection notes for mobile devices

- To use the Smart View function, the mobile device must support a sharing function such as Screen Mirroring or Smart View. To check whether your mobile device supports the sharing function, refer to the mobile device's user manual.
- To use Wi-Fi Direct, the mobile device must support the Wi-Fi Direct function. To check whether your mobile device supports Wi-Fi Direct function, refer to the mobile device's user manual.
- The mobile device and your Smart TV must be connected to each other on the same network.
- The video or audio may stop intermittently, depending on network conditions.
- When sharing content with other network-based devices such as those in an IP (Internet Protocol) storage system, sharing may not be supported due to the network's configuration, quality, or functionality, for example, if the network has an NAS (Network-Attached Storage) device.

Peripherals

Connect external devices such as a keyboard for ease of use.

Using Anynet+ (HDMI-CEC)

Control an external device connected via Anynet+ (HDMI-CEC) with the remote control.

You can use the TV's remote control to control external devices that are connected to the TV by an HDMI cable and that support Anynet+ (HDMI-CEC). Note that you can only set up and operate Anynet+ (HDMI-CEC) with the remote control.







Connecting an external device through Anynet+ and using their menus

[Home](#) > [Settings](#) > [General](#) > [External Device Manager](#) > [Anynet+ \(HDMI-CEC\)](#) [Try Now](#)

1. Set [Anynet+ \(HDMI-CEC\)](#) to **On**.
2. Connect an HDMI-CEC-compliant device to the TV.
3. Turn on the connected external device. The device is automatically connected to the TV. After connection is finished, you can access the menu of the connected device on your TV screen using your TV remote and control the device.

 The connecting process can take up to 2 minutes to complete.

Read before connecting an Anynet+ (HDMI-CEC) device

-  Anynet+ (HDMI-CEC)-enabled devices must be connected to the TV with an HDMI cable. Note that some HDMI cables may not support Anynet+ (HDMI-CEC).
-  Anynet+ cannot be used to control external devices that do not support HDMI-CEC.
-  The TV remote control may not work under certain circumstances. If this occurs, set up the device as an Anynet+ (HDMI-CEC)-enabled device again.
-  Anynet+ (HDMI-CEC) works only with external devices that support HDMI-CEC and only when those devices are either in standby mode or turned on.
-  Anynet+ (HDMI-CEC) can control up to 12 compliant external devices (up to 3 of the same type) except for home theatres. Anynet+ (HDMI-CEC) can control only one home theatre system.
-  To listen to 5.1 channel audio from an external device, connect the device to the TV via an HDMI cable and connect a 5.1 home theatre system directly to the external device's digital audio output connector.

Controlling the TV with a Keyboard or Mouse

Connecting a keyboard or mouse to make it easier to control the TV.

[Home](#) > [Settings](#) > [General](#) > [External Device Manager](#) > [Input Device Manager](#) [Try Now](#)





You can connect a keyboard or mouse to make it easier to control the TV.

Connecting a USB keyboard or mouse

Plug the keyboard or mouse cable into the USB port.

 If you connect a mouse, it is available only in the [Internet](#) app.

Using the keyboard and mouse

Button	Description
Directional keys	Moves the focus
Windows key	Displays the TV settings
Enter key	Selects or runs a focused item
ESC key	Returns to the previous screen
F1 / F2 / F3 / F4 key	Colour buttons —  /  /  / 
F5 key	Displays the Home Screen
F6 key	Displays the Source screen
F7 key	Displays the Channel List
F8 key	Mutes the sound
F9 / F10 key	Adjusts the volume
F11 / F12 key	Changes the channel
Page Up / Page Down	Scrolls a web page displayed on the Internet app.

Button	Description
Left-click	Available only in the Internet app. You can click a menu or link to start a function as you do on a PC.
Right-click	Available only in the Internet app. You can use the following functions:  The options displayed on the menu may differ depending on the selected item. <ul style="list-style-type: none"> • Open • Open Link in New Tab • Enable Scroll Mode

 Some functions may not be supported depending on the model or geographical area.

 The key operations may differ on some apps.

Setting up the input devices

Setting up the keyboard

[Home](#) > [Settings](#) > [General](#) > [External Device Manager](#) > [Input Device Manager](#) > [Keyboard Settings](#)

You can set up the keyboard with the following functions:

- [Keyboard Language](#)
- [Keyboard type](#)

Setting up the mouse

[Home](#) > [Settings](#) > [General](#) > [External Device Manager](#) > [Input Device Manager](#) > [Mouse Settings](#)

You can set up the mouse with the following functions:

- [Primary Button](#)
- [Pointer Speed](#)

Entering Text using the On-Screen Virtual Keyboard

Use the Virtual keyboard to enter text on your TV.

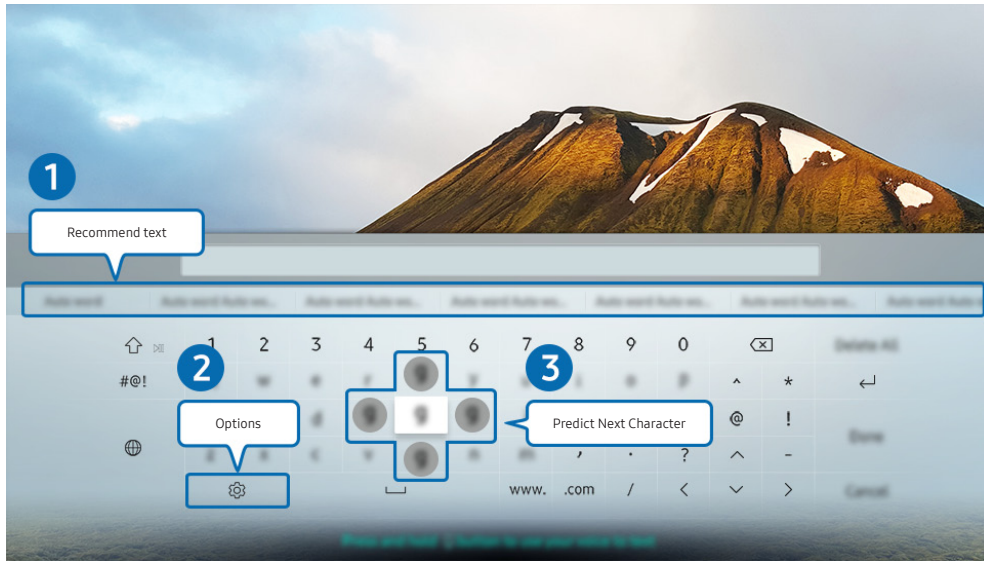

 The image on your TV may differ from the image above depending on the model and geographical area.

1 Recommend text

When you type a word you want to search for, this function shows related suggestions from which you can choose one.

2 Options

Select  on the Virtual keyboard screen. The following options are available:

 The options available may differ depending on the function running currently.

- [Recommend text](#)
- [Reset Recommended Text Memory](#)
- [Predict Next Character \(when using direction buttons\)](#)
- [Language](#)

3 Predict Next Character

Each time you type a character on the Virtual keyboard, the next characters predicted to be typed are displayed, and you can use the directional buttons on the remote control to select one from them.







Smart Features

You can enjoy various apps with Smart Hub.

Smart Hub

View descriptions of Smart Hub's basic functions.

From Smart Hub, you can use the Internet search function, install and use various apps, view photos and videos or listen to music stored on external storage devices, and perform more functions.

-  Some of the **Smart Hub** services are paid services.
-  To use **Smart Hub**, the TV must be connected to the Internet.
-  Some **Smart Hub** features may not be supported depending on the service provider, language, or geographical area.
-  **Smart Hub** service outages can be caused by disruptions in your Internet service.
-  To use Smart Hub, you must agree to the Smart Hub service agreement, and collection and use of personal information. Without giving consent, you cannot use the additional features and services. You can view the entire text of the **Terms & Privacy** by navigating to [🏠](#) > [⚙️ Settings](#) > [Terms & Privacy](#). [Try Now](#)
-  If you want to stop using **Smart Hub**, you can cancel the agreement. To cancel the Smart Hub service agreement though it is a required one, select **Reset Smart Hub** ([🏠](#) > [⚙️ Settings](#) > [Support](#) > [Self Diagnosis](#) > [Reset Smart Hub](#)).

Displaying the Home Screen

Press the  button.

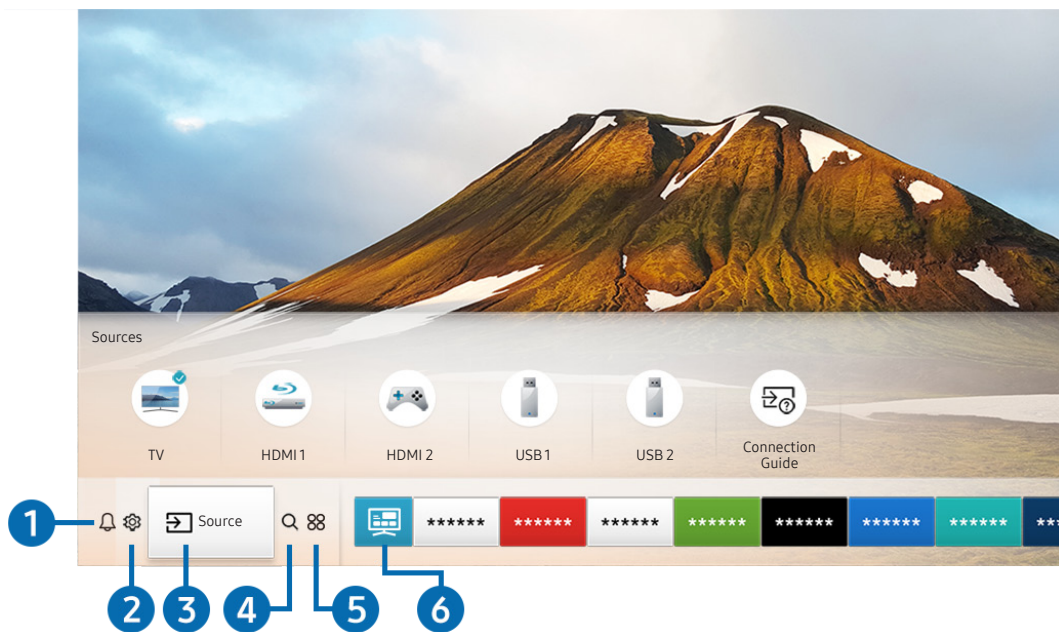



 The image on your TV may differ from the image above depending on the model and geographical area.

On the Home Screen, you can easily run the apps you have used previously or frequently. The apps can also be moved or deleted from the screen.

1 Notification

You can view a list of notifications for all events that occur on your TV. A notification appears on the screen when it is time to broadcast a scheduled programme or when an event occurs on a registered device.

If you move the focus to **Notification**, and then press the Select button, a notification window appears on the right and the following functions are available:

-  **Delete All**
You can delete all your notifications.
-  **Settings**
 - You can select services you want to be notified about.
 - When you select **Allow sound**, notifications are displayed with a notification sound.

2 Settings

When the focus is moved to the  icon, a list of quick settings icons appears above the top of the menu. You can quickly set frequently used functions by clicking the icons.

- **Picture Mode**

You can select the picture mode that provides the best viewing experience. To change the picture mode, press the Select button. To make fine adjustments, press the up directional button, and then select [Picture Setup](#).

- **Sound Mode**

You can select a sound mode to optimise your listening experience. To change the sound mode, press the Select button. To make fine adjustments, press the up directional button, and then select [Equaliser Setup](#).

- **Sound Output**

You can select which speakers the TV uses for audio output. To change the audio output, press the Select button.

- **Audio Language**

You can change the audio language you want to hear. To make fine adjustments, press the up directional button, and then select [Go to Audio Options](#).

- **Game Mode**

You can enable game mode to optimise the TV's settings for playing video games with a gaming console, such as a PlayStation™ or Xbox™. To turn [Game Mode](#) on or off, press the Select button. To set the detailed options, press the up directional button, and then select [Go to Game Mode Settings](#).



This function may not be supported depending on the model or geographical area.

- **Subtitle**

You can watch TV broadcasts with subtitles. To activate/deactivate the [Subtitle](#) function, press the Select button. To run [Accessibility Shortcuts](#), press the up directional button, and then select [Accessibility Shortcuts](#).

- **Sleep Timer**

You can automatically shut off the TV after a pre-set period of time.

To set the sleep time to up to 180 minutes, press the Select button. To make detail off timer, press the up directional button, and then select [Set Up Off Timer](#).



This function may not be supported depending on the model or geographical area.

- **Network**

You can view the current network and Internet status. Press the up directional button, and then select [Network Status](#) or [Network Settings](#).



Pressing  [Settings](#) displays all setting menus available.



This function may not be supported depending on the model or geographical area.

3 Source

You can select an external device connected to the TV.

 For more information, refer to "[Switching between external devices connected to the TV](#)".

4 Search

You can search for channels, programmes, movie titles, and apps from Smart Hub.

 To use this feature, the TV must be connected to the Internet.

5 APPS

You can enjoy a wide range of content including news, sports, weather, and games by installing the corresponding apps on your TV.

 To use this feature, the TV must be connected to the Internet.

 For more information, refer to "[Using the Apps Service](#)".

6 Universal Guide

Universal Guide is an app that allows you to search for and enjoy various content such as TV shows, dramas, and movies in one place. **Universal Guide** can recommend content tailored to your preferences and notify you of new drama series.

 For more information about the **Universal Guide**, refer to "[Using the Universal Guide App](#)".

 Images may look blurry depending on the service provider's circumstances.

 This function may not be supported depending on the model or geographical area.

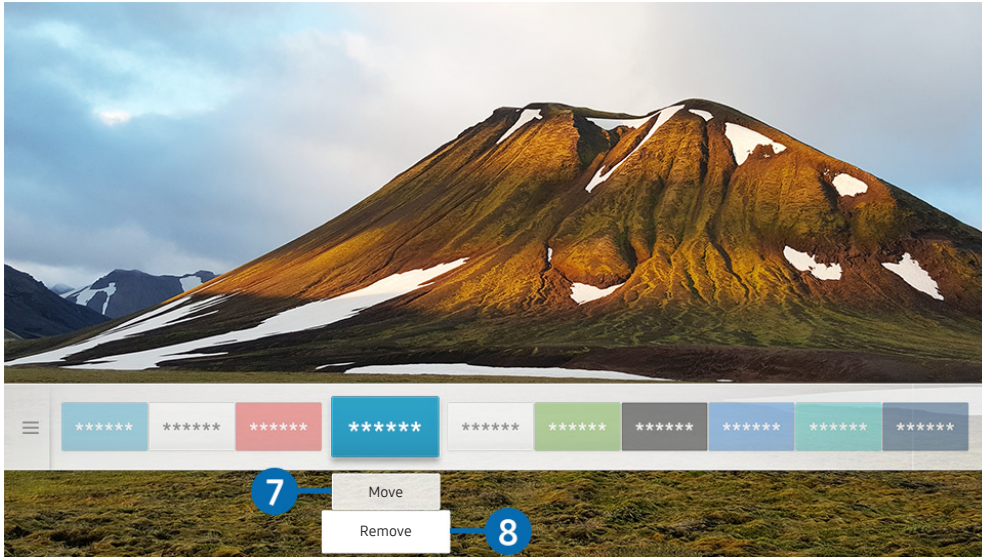

 The image on your TV may differ from the image above depending on the model and geographical area.

7 Moving an item on the Home Screen

Move the focus to the app you want to move, press the down directional button on the remote control, and then select **Move**. Move the app to the desired position by pressing the left or right directional button, and then press the Select button. The selected app is moved on the Home screen.

8 Removing an item on the Home Screen

Move the focus to the app you want to delete, press the down directional button on the remote control, and then select **Remove**. The selected app is deleted.

 You can add the apps you want to use often to the Home Screen using APPS. To add your favourite apps to the Home Screen, refer to "[Managing purchased or installed apps](#)".

Launching Smart Hub automatically

[Home](#) > [Settings](#) > [General](#) > [Smart Features](#) > [Autorun Smart Hub](#) [Try Now](#)

When you set [Autorun Smart Hub](#) to **On**, the TV displays the Home Screen automatically when you turn the TV on. You can also turn on or off this function, use the Select button.

Launching the last used app automatically

[Home](#) > [Settings](#) > [General](#) > [Smart Features](#) > [Autorun Last App](#) [Try Now](#)

If [Autorun Last App](#) is set to **On**, the last used app is automatically run when you turn on the TV. You can also turn on or off this function, use the Select button.

 This function may not be supported depending on the app.

Testing Smart Hub connections

[Home](#) > [Settings](#) > [Support](#) > [Self Diagnosis](#) > [Start Smart Hub Connection Test](#) [Try Now](#)

Resetting Smart Hub

[Home](#) > [Settings](#) > [Support](#) > [Self Diagnosis](#) > [Reset Smart Hub](#) [Try Now](#)



 You can reset the Smart Hub settings. To reset Smart Hub, enter the PIN. The default PIN is "0000" (for France and Italy: "1111"). You can set the PIN in [Home](#) > [Settings](#) > [General](#) > [System Manager](#) > [Change PIN](#).

Using a Samsung account

Create and manage your own Samsung account.

[Home](#) > [Settings](#) > [General](#) > [System Manager](#) > [Samsung Account](#) Try Now



Creating and managing your Samsung account

-  You can view the entire text of the Terms and Privacy Policy in [Home](#) > [Settings](#) > [General](#) > [System Manager](#) > [Samsung Account](#) > [My Account](#) > [Terms & Conditions, Privacy Policy](#) after logging in to your Samsung account.
-  You can also create a Samsung account at <https://account.samsung.com>. Once you have an account, you can use the same ID on both the TV and the Samsung website.
-  [Add Account](#) appears or not, depending on whether you are logged in to your Samsung account.

Creating a new account

[Home](#) > [Settings](#) > [General](#) > [System Manager](#) > [Samsung Account](#) > [\(Add Account\)](#) > [Create Account](#)

To create a new Samsung account, follow the instructions on the screen.

-  For more information about the terms, select [View Details](#).
-  To protect personal information, select [Profile image selection and password entry \(High security\)](#) in the field below the password entry bar.
-  If you want the TV to log you into your account automatically whenever you turn on the TV, click [Sign me in automatically](#).

Creating a Samsung account using a PayPal account

[Home](#) > [Settings](#) > [General](#) > [System Manager](#) > [Samsung Account](#) > [\(Add Account\)](#) > [Create with PayPal](#)

-  This function may not be supported depending on the model or geographical area.

Signing in to a Samsung account

[Home](#) > [Settings](#) > [General](#) > [System Manager](#) > [Samsung Account](#) > [Sign In](#)

Changing and adding information to a Samsung account

[Home](#) > [Settings](#) > [General](#) > [System Manager](#) > [Samsung Account](#) > [My Account](#) > [Edit profile](#)

 To change the account information, you must be logged in to your Samsung account.

Managing payment information saved on the TV

[Home](#) > [Settings](#) > [General](#) > [System Manager](#) > [Samsung Account](#) > [My Account](#) > [Payment Info](#)

 To manage the payment information, you must be logged in to your Samsung account.

 This function may not be supported depending on the model or geographical area.

Configure the Sync Internet settings

[Home](#) > [Settings](#) > [General](#) > [System Manager](#) > [Samsung Account](#) > [My Account](#) > [Sync Internet](#)

Once you sign in to your Samsung account and configure the sync Internet settings, you can share your favourites that you registered using other devices.

 To configure the [Sync Internet](#) settings, you must be logged in to your Samsung account.

 This function may not be supported depending on the model or geographical area.

Deleting a Samsung account from the TV

[Home](#) > [Settings](#) > [General](#) > [System Manager](#) > [Samsung Account](#) > [My Account](#) > [Remove Account](#)

 To remove account information, you must be logged in to your Samsung account.

 Although you delete your Samsung account, you are not unsubscribed yet. To unsubscribe from your Samsung Account, visit the Samsung Accounts website (<https://account.samsung.com>).

Signing out of your Samsung account

To sign out of your Samsung account, move the focus to your account at [Home](#) > [Settings](#) > [General](#) > [System Manager](#) > [Samsung Account](#), and then press the Select button. Or move to [My Account](#) ([Home](#) > [Settings](#) > [General](#) > [System Manager](#) > [Samsung Account](#) > [My Account](#)), and then select [Sign out](#).

Viewing the user agreement and privacy policy

[Home](#) > [Settings](#) > [General](#) > [System Manager](#) > [Samsung Account](#) > [My Account](#) > [Terms & Conditions, Privacy Policy](#)

 To view the user agreement and privacy policy, you must be logged in to your Samsung account.

Using the Apps Service

Download and run various apps from Smart Hub.

🏠 > 📺 APPS

You can enjoy a wide range of content including news, sports, weather, and games by installing the corresponding apps on your TV.

- ✍️ To use this feature, the TV must be connected to the Internet.
- ✍️ When Smart Hub is launched for the first time, the default apps are automatically installed. The default apps may differ depending on the geographical area.

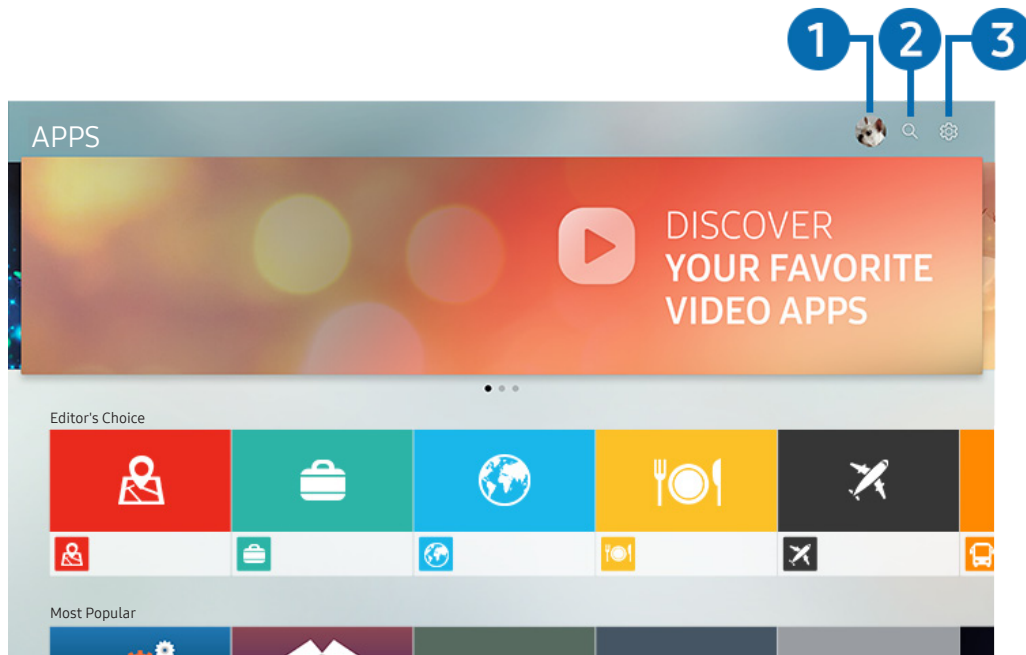

- ✍️ The image on your TV may differ from the image above depending on the model and geographical area.

1 👤 Sign In

Go to the [Samsung Account](#) screen to create a new account or sign in to your account.

2 🔍 App Search

You can search for available apps.

3 ⚙️ Settings

You can manage the installed apps.

Installing and running an app

Installing an app

1. Move to the app you want to install, and then press the Select button. The detailed information screen appears.
2. Select **Install**. When the installation is completed, the **Open** menu appears.
3. Select **Open** to run the app immediately.

 You can view installed apps on the **Settings** screen.

 If the TV's internal memory is insufficient, you can install some specific apps on a USB device.





 You can run an app installed on a USB device only when the USB device is connected to the TV. If the USB device is disconnected while an app is running, the app is terminated.

 You cannot run an app installed on a USB device on a PC or another TV.

Launching an app

You can run the app desired from **Downloaded App**.

The icons below appear within the selected app's icon and indicate the following:

-  : The app is installed on a USB device.
-  : The app has a password.
-  : The app needs to be updated.
-  : The app supports mirroring function.

Managing purchased or installed apps

Select  **Settings** on **APPS**. You can manage installed apps.

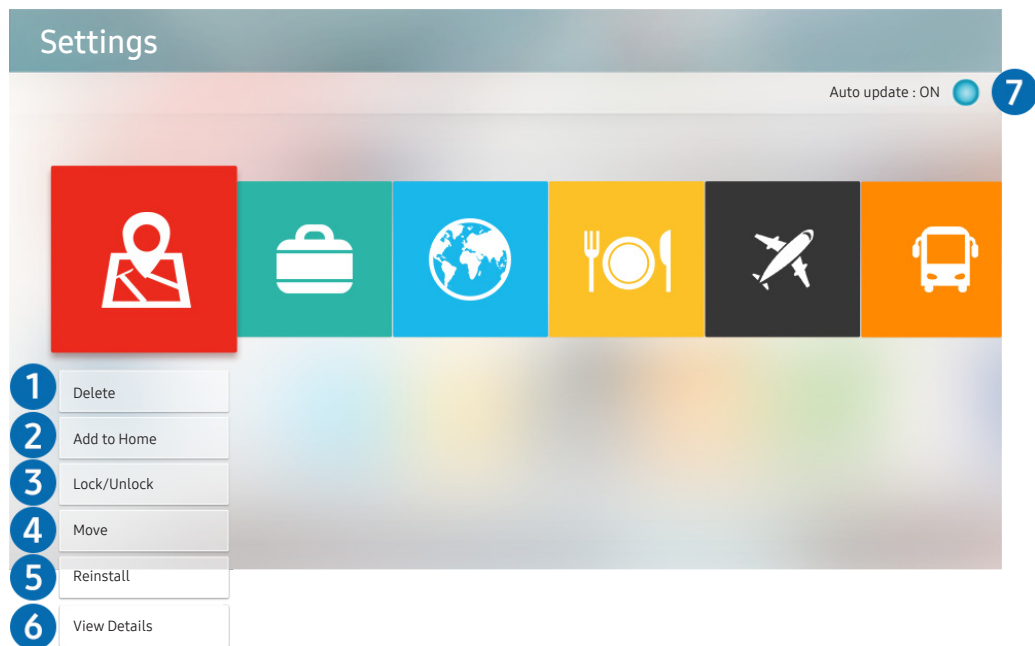

 The image on your TV may differ from the image above depending on the model and geographical area.

1 Removing an app

1. Move the focus to an app to delete.
2. Select **Delete**.
3. The selected app is deleted.

 Ensure that the related app data is also removed when you remove an app.

 Standard apps cannot be uninstalled.

2 Adding apps to the Home Screen

1. Move the focus to an app to add.
2. Select **Add to Home**.
3. After the Home screen appears, move the selected app to the desired location.
4. Press the Select button.
5. The selected app is added to the Home Screen.

3 Locking and unlocking apps

1. Move the focus to an app to lock or unlock.
2. Select [Lock/Unlock](#).
3. The selected app is locked or unlocked.

 To lock or unlock an app, enter the PIN. The default PIN is "0000" (for France and Italy: "1111"). You can set the PIN in [Home](#) > [Settings](#) > [General](#) > [System Manager](#) > [Change PIN](#).

4 Moving apps

1. Move the focus to an app to move.
2. Select [Move](#).
3. Move the selected app to the desired location.
4. Press the Select button.
5. The selected app is moved.

 This function may not be supported depending on the model or geographical area.

5 Reinstalling an app

1. Move the focus to the app to install again.
2. Select [Reinstall](#).
3. Reinstallation starts.

6 Checking the app information details

1. Move the focus to the app to check.
2. Select [View Details](#).
3. The app information screen appears.

7 Automatically updating apps

Installed apps can be automatically updated. If you do not want apps automatically updated, set [Auto update](#) to **OFF**.

 Automatic update is enabled only when the TV is connected to the Internet.

Rating apps

You can rate an app on the detailed information screen.

Using the Gallery App

View photos and videos synchronised with the Samsung Cloud.

 > Gallery

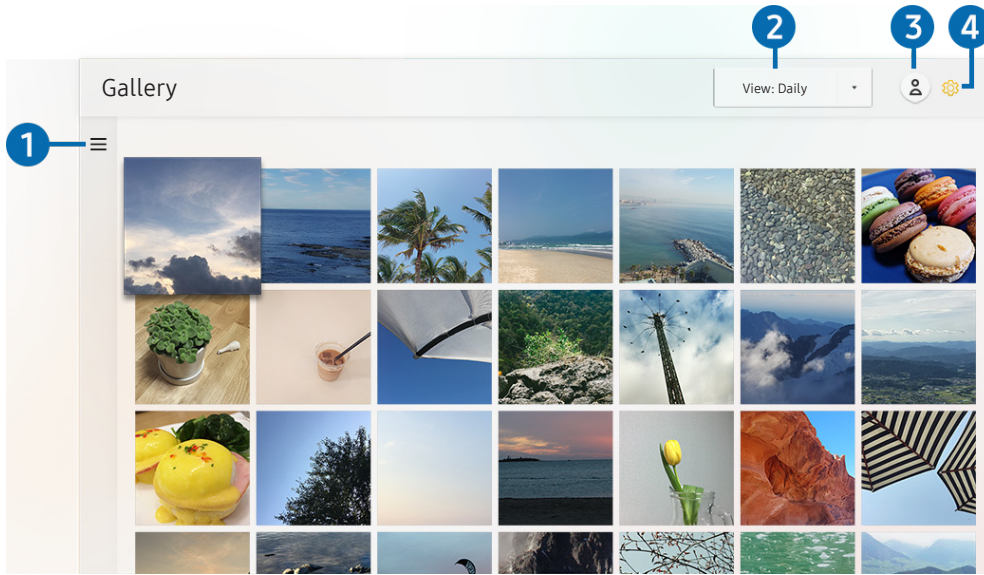

 The image on your TV may differ from the image above depending on the model and geographical area.

You can enjoy various content synchronised with a mobile device that supports the Samsung Cloud. The available content types are photos, videos, stories, and other content shared through your groups.

If you have shared content from your groups, you can access them in notifications.

 To use the [Gallery](#) app, you must be signed in to your Samsung account.

 This function may not be supported depending on the model or geographical area.

1 Open category

Move to  at the top left of the screen using the directional buttons on the remote control to view the content synchronised with the Samsung Cloud by category.

2 View: Daily / View: Monthly

Sort the content by day or month.

3 Sign In

Go to the [Samsung Account](#) screen to create a new account or sign in to your account.

4 Gallery Settings

Restrict access to the [Gallery](#) app to protect your privacy, or view the user agreement and privacy policy.

Using the Universal Guide App

Search for and enjoy content such as TV shows, dramas, movies, and sports broadcasts.



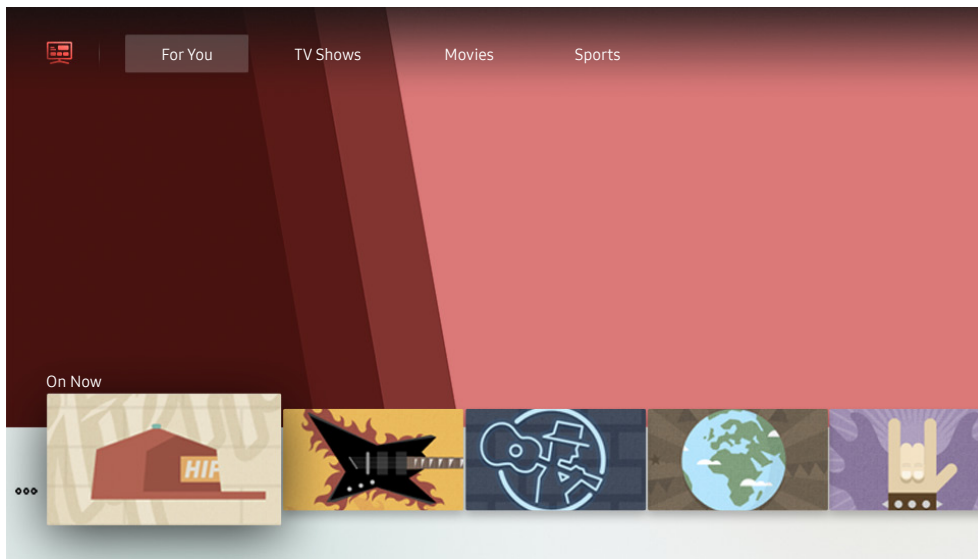

 >  Universal Guide



 The image on your TV may differ from the image above depending on the model and geographical area.

Universal Guide is an app that allows you to search for and enjoy various content such as TV shows, dramas, and movies in one place. **Universal Guide** can recommend content tailored to your preferences and notify you of new drama series.

You can use this feature on your mobile with Samsung SmartThings app.

-  To enjoy the content from these apps on your TV, they must be installed on the TV.
-  When you watch some paid content, you may need to make a payment using their associated app.
-  Images may look blurry depending on the service provider's circumstances.
-  This function may not be supported depending on the model or geographical area.

Using the SmartThings App

Monitor and configure the smart devices you have connected to the SmartThings service.

 > SmartThings

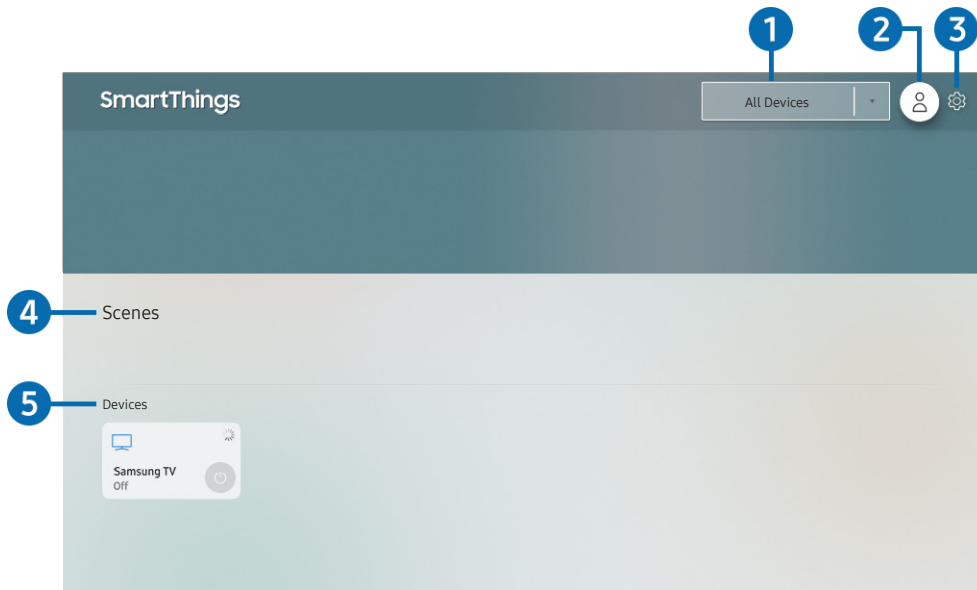

 The image on your TV may differ from the image above depending on the model and geographical area.

From the TV, you can monitor and configure your smart devices connected to the SmartThings service via the SmartThings app installed on them. You can receive notifications about the statuses of your smart devices.

 To use this function, you must be logged in to your Samsung account.

 This function may not be supported depending on the model or geographical area.

1 Location selection list

Press the Select button to identify all connected devices or the devices specific to a location.

2 Sign In

Go to the [Samsung Account](#) screen to create a new account or sign in to your account.

3 Settings

Turn notifications on or off for the connected smart devices.

4 Scenes

Control multiple devices with one command after setting scenes via the SmartThings app on your mobile device.

 The Scenes function is only available on a connected smart device.

5 Device list

View a list of the connected smart devices and their statuses.

You can add a new device through the SmartThings app on your mobile device. Please refer to the user guide in the SmartThings app on your mobile device for more details.

Using the e-Manual

Control and read the manual embedded in your TV.

Launching the e-Manual





 >  [Settings](#) > [Support](#) > [Open e-Manual](#)

You can view the embedded e-Manual that contains information about your TV's key features.

 Alternatively, you can download a copy of the e-Manual from Samsung's website.

 Words in blue (e.g., [Picture Mode](#)) indicate a menu item.

Using the buttons in the e-Manual

-  (**Search**): Select an item from the search results to load the corresponding page.
- **A-Z (Index)**: Select a keyword to navigate to the relevant page.
-  The menus may not appear depending on the geographical area.
-  (**Recent pages**): Select a topic from the list of recently viewed topics.
-  (**Try Now**): Allows you to access the corresponding menu item and try out the feature right away.
-  (**Link**): Access an underlined topic referred to on an e-Manual page immediately.





 Some menu screens cannot be accessed from the e-Manual.

Using the Internet

Surf the Internet on your TV.

> **Internet**

When you run **Internet**, you can see recently viewed web sites or featured recommendations. When you select a desired web site, you can get immediate access to it.

-  You can use the **Internet** more easily after connecting a keyboard and mouse.
-  You can scroll web pages with the Directional pad.
-  The web pages may differ from those on a PC.
-  Before using the **Internet**, refer to "Read Before Using the Internet".

Playing pictures/video/music

Play media content stored on your TV, USB devices, mobile devices, cameras, PCs, etc.

Home > Source > Connected Device Try Now

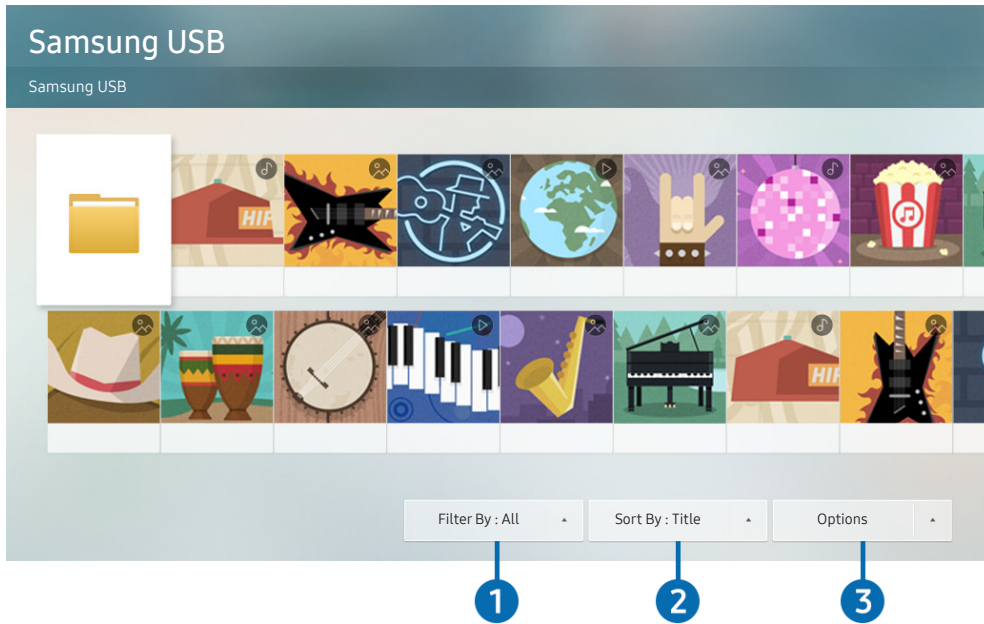

The image on your TV may differ from the image above depending on the model and geographical area.

You can play media content saved on storage devices, such as USB devices, mobile devices, and cameras, on the TV.

You cannot play media content if the content or the storage device is not supported by the TV. For more information, refer to "[Read Before Playing Photo, Video, or Music Files](#)".

Backup important files before connecting a USB device. Samsung is not responsible for damaged or lost files.

You can use the following functions on the media content list screen of a storage device.

1 Filter By

Filters the media content by type of media.

2 Sort By

Sorts the content list.

 This function may not be supported depending on the type of external device.



3 Options

Deletes or plays the selected media content in the media content list. When you select **Refresh**, the content list is reloaded.

 You can delete only the recorded content. To delete content, change the **Filter By** option to **Recorded**.

Playing media content

Playing multimedia content on a PC or mobile device

1. Select a device with media content in  >  **Source**. The media content list in the device appears.
2. Select a media content item from the list.
3. The content is played.

 For more information about buttons, refer to "[Buttons and functions available while playing multimedia content](#)".

 The content may not be played depending on the encoding method or file format. Furthermore, several functions may be restricted.

 Content on devices connected to the TV via your network may not play smoothly due to the network communication problems. If this occurs, use a USB device.

 For more information about connection to mobile device, refer to "[Connecting Your Mobile Device](#)".

Playing multimedia content on a USB device

1. Connect a USB device to the USB port. When a pop up message appears on the screen, select **Browse** to easily move to the list of multimedia content stored on the device.
2. Select a content item to play from the list.
3. The content is played back.

TV Viewing

You can use convenient features while watching TV. Additionally, you can edit the channel list or create favourite channel lists.

Viewing Digital Broadcast Information at a Glance

See an overview of each channel's programme lineup.

Using the guide

[Home](#) > [Live TV](#) > [Guide](#) Try Now

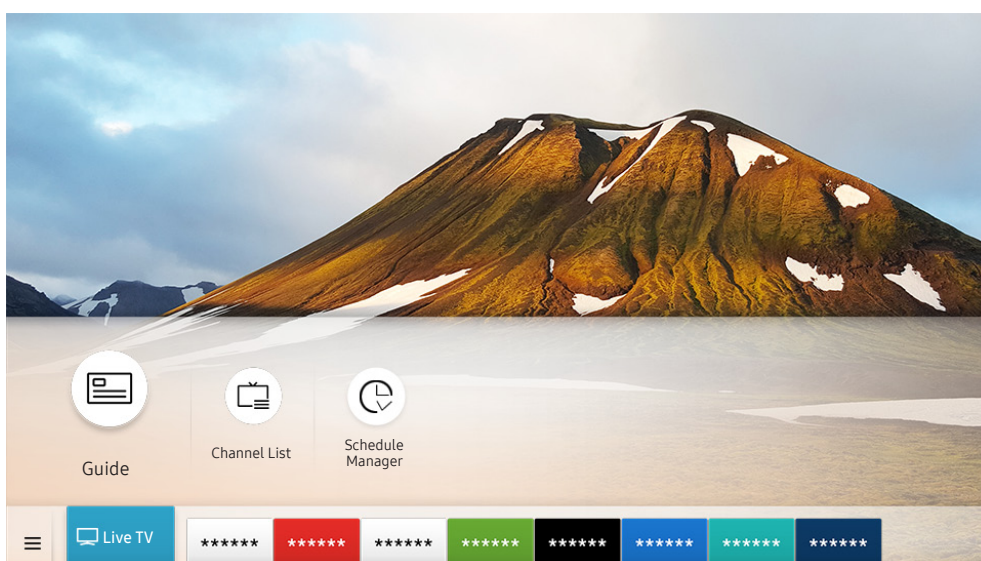

 The image on your TV may differ from the image above depending on the model and geographical area.



In the [Guide](#), you can see the daily programme schedules for each broadcaster, see programme information, choose a programme to watch, and set up a schedule viewing.

 To see information about analogue channels and use the analogue channel functions of the [Guide](#), you must finish the service provider settings in initial setup.

 To view the [Guide](#), you must first set the TV's clock ([Home](#) > [Settings](#) > [General](#) > [System Manager](#) > [Time](#) > [Clock](#)).

 Press the GUIDE button to view the [Guide](#).

To start Schedule viewing, and other function for a programme listed in the [Guide](#), first move the cursor to it and then press and hold Select button on the remote control to use follows functions:

- **Schedule Viewing:** You can schedule viewing of a broadcast scheduled programme.
 -  This function may not be supported depending on the model or geographical area.
 -  For more information about [Schedule Viewing](#), refer to "[Setting Up a Schedule Viewing](#)".
- **Cancel Scheduled Viewing:** You can cancel scheduled viewings.
 -  This function may not be supported depending on the model or geographical area.
- **View Details:** You can see detailed information about the selected programme. The information may differ with the broadcast signal. If information is not provided with the programme, nothing appears.

Setting Up a Schedule Viewing

Configure the TV to show a specific channel or programme at a specific time and date.

-  The  appears next to programmes that have been configured for a schedule viewing.
-  To set up a schedule viewing, you must first set the TV's clock ([Home](#) >  [Settings](#) > [General](#) > [System Manager](#) > [Time](#) > [Clock](#)).

Setting up a schedule viewing for a channel

Using the schedule viewing options from the guide screen

On the [Guide](#) screen, select a programme you would like to view, press the Select button, and then select [Schedule Viewing](#) in the pop-up menu that appears.

Using the schedule viewing options in the programme info window

Press the Select button while watching TV. The Programme Info window appears. Select a programme that will be broadcast using the left or right directional buttons. Press the Select button, and then select [Schedule Viewing](#) to schedule viewing of that programme.

Using schedule viewing to view programmes at a specified time on a specified date

[Home](#) > [Live TV](#) > [Schedule Manager](#) > [Add Viewing](#)

To schedule a Viewing, set the values for [Aerial](#), [Channel](#), [Repeat](#), [Date](#), and [Start Time](#) of the broadcast programme to view, and then select [Save](#).

Check the current time in [Home](#) > [Settings](#) > [General](#) > [System Manager](#) > [Time](#) > [Clock](#).

 The menus may not appear depending on the model or geographical area.

Editing a schedule viewing

[Home](#) > [Live TV](#) > [Schedule Manager](#) > [Scheduled Manually](#)

 You can set up a maximum total of 30 [Schedule Viewing](#) entries.

 The menus may not appear depending on the model or geographical area.

Setting the Schedule Viewing Time

[Home](#) > [Live TV](#) > [Schedule Manager](#) > [Scheduled Manually](#) > [Edit](#)

You can set the start time of a schedule viewing. If you choose a programme from the [Guide](#), the [Start Time](#) can be set up to 10 minutes before the programme.

 The menus may not appear depending on the model or geographical area.

Canceling a scheduled viewing

[Home](#) > [Live TV](#) > [Schedule Manager](#) > [Scheduled Manually](#) > [Delete](#)

 The menus may not appear depending on the model or geographical area.

Checking scheduled viewings

[Home](#) > [Live TV](#) > [Schedule Manager](#) > [Scheduled Manually](#) > [View Details](#)

 The menus may not appear depending on the model or geographical area.



Using the Channel List

Change the channel or check programmes on other digital channels.







 > [Live TV](#) > [Channel List](#)

Using the [Channel List](#), you can change the channel or check programmes on other digital channels while watching TV. Press the CH LIST button to view the [Channel List](#).

The [Channel List](#) screen contains the following icons:

-  : A favourite channel
-  : A locked channel.
-  : CI card required channel.

If you press the right directional button when viewing the [Channel List](#) screen, you can use the following functions:



- [All](#)
Displays the channels that have been automatically searched.
 The channels received to the currently selected [Terrestrial](#), [Cable](#), or [Satellite](#) are displayed.
- [TV PLUS](#)
While the TV is connected to the Internet, you can watch popular programmes or highlights for each theme through a virtual channel at any time. As with regular channels, the TV provides the daily programme schedules for [TV PLUS](#).
 This function may not be supported depending on the model or geographical area.
- [Favourites](#)
Displays [Favourites 1](#) to [Favourites 5](#).
- [Channel Type](#)
Sorts the list so that it includes channels of a selected type. However, [Channel Type](#) can only be used channels contain the type information.
 This function may not be supported depending on the incoming broadcast signal.
- [Sort](#)
Sorts the list by [Number](#) or by [Name](#).
 This option is only available on digital channels and may not always be available.
- [Terrestrial](#), [Cable](#), or [Satellite](#)
Allows you to choose between [Terrestrial](#), [Cable](#), and [Satellite](#).
 This function may not be supported depending on the incoming broadcast signal.
 This function may not be supported depending on the model or geographical area.

Editing channels

Edit the channels stored on your TV.

[Home](#) > [Live TV](#) > [Channel List](#) > [All](#) > [Edit Channels](#)

The [Edit Channels](#) screen icons indicate the following:

- : A favourite channel
- : A locked channel.
- : CI card required channel.

Removing registered channels

To remove a channel, select it from the [Edit Channels](#) screen, and then select [Delete](#). Removed channels do not appear in the [Channel List](#).

Editing registered channels

You can access the following options by selecting [All](#) > [Edit Channels](#):

- Locking or unlocking a channel

After selecting a target channel in [Edit Channels](#), select [Lock](#) or [Unlock](#). Then the channel is locked or unlocked. A locked channel cannot be viewed.

 If you want to set the password, set [Home](#) >  [Settings](#) > [Broadcasting](#) > [Apply Channel Lock](#) to [On](#).

 For more information about how to set your password, refer to "[Setting up a password](#)".

- Changing a channel name

After selecting a channel to change in [Edit Channels](#), select [Rename channel](#) to change the channel name.

 This function is only available for selected channels.

 This function is only available for analogue broadcasts.

- **Change Number**

After selecting a channel to change in **Edit Channels**, select **Change Number** to change the channel number.

 This function may not be supported depending on the model or geographical area.

 When a channel number is changed, its channel information is not updated automatically.

- **Restore TV PLUS**

You can re-scan and store **TV PLUS** channels that have been received.

 If there are **TV PLUS** channels on the TV, after deleting the stored channels, the system stores the newly scanned channels.

 If the TV has saved **TV PLUS** channels, **Restore TV PLUS** deletes the existing list, and then saves the newly scanned channels.

 This function may not be supported depending on the model or geographical area.

Creating a Personal Favourites List

Designate frequently watched channels as favourite channels.

Favourite channels are highlighted in the **Edit Channels** and **Channel List** screens with the  symbol. You can create up to five favourites lists so that your family can create their own personal favourites list.

Registering channels as favourites

 > **Live TV** > **Channel List**

1. Press the right directional button on your remote control.
2. Select **Favourites**.
3. Select one of the five favourites lists.
4. Move to **Edit Favourites**.
5. Select a channel to add to the favourites list.
6. Select  icon.

The selected channel is registered in the favourites list.

Viewing and selecting channels on Favourites lists only

 > [Live TV](#) > [Channel List](#)

1. Press the right directional button on your remote control.
2. Select [Favourites](#).
3. Select the desired list among the five favourites lists on the screen.

The channels in the selected favourites list appear.

 Only favourites lists that contain registered channels will display channels.

Editing a Favourites List

Use the functions that are available while watching TV.

 > [Live TV](#) > [Channel List](#)

After pressing the right directional button on your remote control, select [Favourites](#) > [Favourites 1 - Favourites 5](#) > [Edit Favourites](#). The [Edit Favourites](#) screen appears.

Adding channels to favourites list

Select channels to add and select the  icon. The selected channels are added to Favourites.

Removing channels from a favourites list

Select channels in a favourites list, and then select the  icon.

Rearranging a favourites list

Select one or more channels, and then select [Change order](#). The [Change order](#) highlight appears. Press the up/down directional buttons to indicate the new location for the channels. Press the Select button to set the channels into their new location.

Renaming a favourites list

Select the favourites list you want to rename, and then select [Rename Favourites](#). Enter a new name using the on-screen keyboard that appears, and then select [Done](#).

TV-Viewing Support Functions

Use the functions that are supported by digital or analogue channels.

Changing the broadcast signal

 > [Live TV](#) > [Channel List](#)

After pressing the right directional button on your remote control, and then move the focus to [Terrestrial](#), [Cable](#), or [Satellite](#) press the Select button.

 You do not need to use this function if your TV is connected to a cable box or satellite box.

Scanning for available channels

 >  [Settings](#) > [Broadcasting](#) > [\(Auto Tuning Settings\)](#) > [Auto Tuning](#)

 This function may not be supported depending on the model or geographical area.

 If the TV is connected to a cable box or satellite box, you do not need to do this.

 The DVB-T2 system may not be supported depending on the geographical area.

 The [Auto Tuning Settings](#) may not appear depending on the model or geographical area.

Selecting the cable network search option

 >  [Settings](#) > [Broadcasting](#) > [\(Auto Tuning Settings\)](#) > [Cable Search Option](#)

Sets additional search options such as the frequency and symbol rate for a cable network search.

 This function may not be supported depending on the model or geographical area.

 The [Auto Tuning Settings](#) may not appear depending on the model or geographical area.

Scanning for available channels on standby mode

 >  [Settings](#) > [Broadcasting](#) > [\(Auto Tuning Settings\)](#) > [Standby Auto Tuning](#)

Automatically scan for channels while your TV is in standby mode.

 This function may not be supported depending on the model or geographical area.

 The [Auto Tuning Settings](#) may not appear depending on the model or geographical area.

Setting the Wake-up time

[Home](#) > [Settings](#) > [Broadcasting](#) > [\(Auto Tuning Settings\)](#) > [Wake-up Timer](#)

Schedule timer to turn the TV on and scan channels automatically.

 This function may not be supported depending on the model or geographical area.

 The [Auto Tuning Settings](#) may not appear depending on the model or geographical area.

Checking digital channel signal info and strength

[Home](#) > [Settings](#) > [Support](#) > [Self Diagnosis](#) > [Signal Information](#) [Try Now](#)

 If your TV is attached to a separate, over-the-air antenna, you can use the signal strength information to adjust the antenna for increased signal strength and improved HD channel reception.

 [Signal Information](#) is only available for digital channels.

 This function may not be supported depending on the model or geographical area.

Restricting Viewing to Specific Channels

[Home](#) > [Settings](#) > [Broadcasting](#) > [Apply Channel Lock](#) [Try Now](#)

By selecting the menu, you can turn on or off the [Apply Channel Lock](#) function.

Using Mark Adult Channels

[Home](#) > [Settings](#) > [Broadcasting](#) > [Mark Adult Channels](#)

Enables or disables all adult services. When disabled, adult services will not be available.

 This function may not be supported depending on the model or geographical area.

Selecting the broadcasting audio option

[Home](#) > [Settings](#) > [Broadcasting](#) > [Dual Sound](#) [Try Now](#)

Set audio options for stereo or bilingual broadcasts. For more information, refer to "[Supported broadcasting audio options](#)".

 This function may not be supported depending on the model or geographical area.

Using Programme Rating Lock

[Home](#) > [Settings](#) > [Broadcasting](#) > [Programme Rating Lock](#) Try Now

 This function may not be supported depending on the model or geographical area.

This function is useful for controlling what children watch on TV. [Programme Rating Lock Settings](#) does not, however, block programmes originating from external sources, such as Blu-ray players, DVD players, or USB files.

Every time you access [Programme Rating Lock Settings](#), you must enter the security PIN. You must also enter this PIN to watch a blocked programme. The default PIN is "0000" (for France and Italy: "1111"). To change the PIN, go to

[Home](#) > [Settings](#) > [General](#) > [System Manager](#) > [Change PIN](#).

 For more information about how to set your password, refer to "[Setting up a password](#)".

 The [Broadcasting](#) is not available in HDMI or Component mode.

 [Programme Rating Lock](#) may not be supported depending on your input signal.

Configuring advanced broadcasting settings

[Home](#) > [Settings](#) > [Broadcasting](#) > [Expert Settings](#) Try Now

Reading digital text

[Home](#) > [Settings](#) > [Broadcasting](#) > [Expert Settings](#) > [Digital Text](#)

You can use this function when you watch a broadcast that includes both text and multimedia content.

 This function is only available in UK.

 Multimedia and Hypermedia Information Coding Experts Group (MHEG) is an International standard for data encoding systems used in multimedia and hypermedia. This is at a higher level than the MPEG system which includes data-linking hypermedia such as still images, character service, animation, graphic and video files as well as multimedia data. MHEG is user runtime interaction technology and is being applied to various fields including Video-On-Demand (VOD), Interactive TV (ITV), Electronic Commerce (EC), tele education, teleconferencing, digital libraries and network games.

Selecting the broadcast audio language

[Home](#) > [Settings](#) > [Broadcasting](#) > [Expert Settings](#) > [Audio Options](#) Try Now

This is the language you will hear while watching TV if the language is included in the broadcast signal. [Audio Options](#) functions differently for analogue and digital channels.

 This function may not be supported depending on the model or geographical area.

Selecting a Language

[Home](#) > [Settings](#) > [Broadcasting](#) > [Expert Settings](#) > [Audio Options](#) > [Audio Language Settings](#)

You can change the audio language you want to hear.

 The available language may differ with the broadcast.

Selecting a Audio Format

[Home](#) > [Settings](#) > [Broadcasting](#) > [Expert Settings](#) > [Audio Options](#) > [Audio Format](#)

You can change the audio format you want to hear.

 The supported audio format may differ with the broadcast programme.

 This option is only available on digital channels.

Tuning broadcast signals manually

[Home](#) > [Settings](#) > [Broadcasting](#) > [Expert Settings](#) > [Manual Tuning](#) Try Now

You can scan for all the channels manually and store the scanned channels in the TV. To stop scanning, select [Stop](#).

 This function may not be supported depending on the model or geographical area.

Tuning digital channels

[Home](#) > [Settings](#) > [Broadcasting](#) > [Expert Settings](#) > [Manual Tuning](#) > [Digital Channel Tuning](#)

Select [New](#) > [Search](#) to scan for digital channels automatically and store the scanned channel list in the TV.

Tuning analogue channels

[Home](#) > [Settings](#) > [Broadcasting](#) > [Expert Settings](#) > [Manual Tuning](#) > [Analogue Channel Tuning](#)

Select [New](#) and configure [Programme](#), [Colour System](#), [Sound System](#), [Channel](#), and [Search](#) to scan for analogue channels. Then, select [Store](#) to store the scanned channels in the TV.

 This function is only available for analogue broadcasts.

Fine-tuning analogue broadcasts

[Home](#) > [Settings](#) > [Broadcasting](#) > [Expert Settings](#) > [Fine Tune](#) Try Now

 This function is only available for analogue broadcasts.

Transferring channel list

[Home](#) > [Settings](#) > [Broadcasting](#) > [Expert Settings](#) > [Transfer Channel List](#)

You can import or export the channel list to a USB storage. To use this function, the PIN number is required.

- [Import from USB](#): Imports channel list from a USB storage.
- [Export to USB](#): Exports channel list saved in the TV to a USB storage.

 This function is available when USB is connected.

 This function may not be supported depending on the model or geographical area.

Enabling/Disabling Edit Channel Numbers

[Home](#) > [Settings](#) > [Broadcasting](#) > [Expert Settings](#) > [Edit Channel Numbers](#)

Use this to change channel number. When channel number is changed, channel information is not updated automatically.

 This function may not be supported depending on the model or geographical area.

Deleting CAM operator profile

[Home](#) > [Settings](#) > [Broadcasting](#) > [Expert Settings](#) > [Delete CAM Operator Profile](#)

 This function may not be supported depending on the model or geographical area.

Setting satellite system

[Home](#) > [Settings](#) > [Broadcasting](#) > [Expert Settings](#) > [Satellite System](#)

You can configure a set of satellite dish settings before performing a channel scan.

 This function may not be supported depending on the model or geographical area.

Changing teletext language

[Home](#) > [Settings](#) > [Broadcasting](#) > [Expert Settings](#) > [Teletext Language Settings](#) > [Teletext Language](#)

You can set or change the teletext language. To watch the teletext broadcast in your preferred language, select a language to use in [Primary Teletext Language](#). If this language is not supported, you can watch the teletext broadcast in your secondary preferred language set in [Secondary Teletext Language](#).

 This function may not be supported depending on the model or geographical area.

Showing TVkey Interface menu

[Home](#) > [Settings](#) > [Broadcasting](#) > [Expert Settings](#) > [TVkey Interface](#)

Show TVkey Interface menu information.

- [TVkey Menu](#): Show TVkey Interface menu.
- [Guide](#): Select the guide you want to use when watching with TVkey.
- [Delete TVkey Operator Profile](#): Show the TVkey operator list to delete.

 This function may not be supported depending on the model or geographical area.

Showing common interface menu

[Home](#) > [Settings](#) > [Broadcasting](#) > [Common Interface](#)

You can view information about common interfaces.

- **CI Menu**

Enables the user to select from the CAM-provided menu. Select the CI menu based on the menu PC Card.

- **Application Info**

Displays information about the CAM inserted into the CI slot and about the “CI or CI+ CARD” inserted into the CAM. You can install the CAM any time, with or without the TV turned on.

- **CICAM PIN Manager**

Manages Common Interface Common Access Module (CICAM) PIN. Save PIN or change stored PIN and then set other PIN options.



This function may not be supported depending on the model or geographical area.

- **Descramble Mode**

- **CAM video transcoding**

Configures the setting to transcode the video codec from the CAM automatically. Turn it Off if you do not want to use it.



You must use a CAM that supports video codec transcoding.



This function may not be supported depending on the model or geographical area.

Picture and Sound

You can change the settings for the picture and the sound according to your preference.

Adjusting the Picture Quality

Change the Picture Mode and adjust Expert Settings.

Choosing a picture mode

 >  [Settings](#) > [Picture](#) > [Picture Mode](#) [Try Now](#)

You can select the [Picture Mode](#) that provides the best viewing experience.

- [Dynamic](#)
Makes the picture brighter and clearer in bright viewing environments.
- [Standard](#)
Is the default mode suitable for general viewing environments.
- [Natural](#)
Reduces eye strain for a comfortable viewing experience.
- [Movie](#)
Is suitable for watching TV or movies in a dark room.

 This function may not be supported depending on the model.

Configuring advanced picture settings

[Home](#) > [Settings](#) > [Picture](#) > [Expert Settings](#) [Try Now](#)

Configure the screen settings to your taste by using the following functions:

- [Backlight](#) [Try Now](#)
- [Brightness](#) [Try Now](#)
- [Contrast](#) [Try Now](#)
- [Sharpness](#) [Try Now](#)
- [Colour](#) [Try Now](#)
- [Tint \(G/R\)](#) [Try Now](#)
- [Apply Picture Settings](#) [Try Now](#)
- [Digital Clean View](#) [Try Now](#)
- [Contrast Enhancer](#) [Try Now](#)
- [Film Mode](#) [Try Now](#)



This function is only available when the input signal is TV, AV, Component (480i, 576i, 1080i), or HDMI (1080i).

- [Colour Tone](#) [Try Now](#)
- [White Balance](#) [Try Now](#)
- [Gamma](#) [Try Now](#)
- [Colour Space Settings](#) [Try Now](#)
- [Reset Picture](#) [Try Now](#)





Setting the Viewing Environment for External Devices

You can optimise the TV for viewing specific video formats.

Playing games on an optimised screen

[Home](#) > [Settings](#) > [General](#) > [External Device Manager](#) > [Game Mode](#)

You can enable the game mode to optimise the TV's settings for playing video games with a gaming console, such as a PlayStation™ or Xbox™.

-  The game mode is not available for normal TV viewing.
-  The screen may shake somewhat.
-  When **Game Mode** is enabled, **Picture Mode** and **Sound Mode** are switched to **Game** automatically.
-  To use other external device on the same port, remove the game console connection, set **Game Mode** to **Off**, and then connect the external device to the port.

Using HDMI black level

[Home](#) > [Settings](#) > [General](#) > [External Device Manager](#) > [HDMI Black Level](#) [Try Now](#)

Use HDMI Black Level to adjust the black level to compensate for low black levels, low contrast, or dull colours generated by external devices connected to the TV via an HDMI cable.

-  This function is only available when the input signal, connected to the TV via an HDMI connector, is set to RGB444.

Picture Support Functions

Configure the picture settings for your TV.

Changing the picture size

[Home](#) > [Settings](#) > [Picture](#) > [Picture Size Settings](#) > [Picture Size](#) **Try Now**

You can change the size of the picture displayed on the TV screen.

- [16:9 Standard](#)
- [Custom](#)
- [4:3](#)

 Supported picture sizes differ with the input signal. For more information about supported picture sizes, refer to "[Picture sizes and input signals](#)".

Changing the picture size automatically

[Home](#) > [Settings](#) > [Picture](#) > [Picture Size Settings](#) > [Auto Wide](#) **Try Now**

 This function may not be supported depending on the model or geographical area.

Changing the picture size in 4:3 or Screen Fit mode

[Home](#) > [Settings](#) > [Picture](#) > [Picture Size Settings](#) > [4:3 Screen Size](#) **Try Now**

The supported screen sizes differ with the country and this function allows you to adjust the picture size in this case.

 This function is may not available when an external device is connected to the TV via a Component connector or an HDMI connector.

 This function may not be supported depending on the model or geographical area.

Fitting the picture to the screen

[Home](#) > [Settings](#) > [Picture](#) > [Picture Size Settings](#) > [Fit to screen](#) [Try Now](#)

 This function may not be supported depending on the [Picture Size](#) setting.

 This function may not be supported depending on broadcasting signals or input sources.

Adjusting the picture size and/or position

[Home](#) > [Settings](#) > [Picture](#) > [Picture Size Settings](#) > [Zoom and Position](#) [Try Now](#)

 This function is available only if [Picture Size](#) is set to [Custom](#).

 To change the picture position on analogue channels, first enlarge the picture and then change the position.

Configuring a Sound Mode and Expert Settings

Change the Sound Mode and adjust Expert Settings.

Choosing a sound mode

[Home](#) > [Settings](#) > [Sound](#) > [Sound Mode](#) [Try Now](#)

You can select a favourite sound mode suitable for the content type or the listening environment.

- [Standard](#)
- [Optimised](#)
- [Amplify](#)

 This function may not be supported depending on the model.

 When an external device is connected, [Sound Mode](#) may change accordingly.

Configuring advanced sound settings

[Home](#) > [Settings](#) > [Sound](#) > [Expert Settings](#) [Try Now](#)

You can personalise the sound quality by adjusting the following settings.

- [Balance](#) [Try Now](#)
- [Equaliser](#) [Try Now](#)
- [HDMI Input Audio Format](#) [Try Now](#)
- [Digital Output Audio Format](#) [Try Now](#)

 If you use a receiver that does not support Dolby Digital Plus, you will hear no sound if you select [Dolby Digital+](#).

 The [Dolby Digital+](#) option is only available via ARC(HDMI) for external devices that support the format.

- [Audio Delay](#) [Try Now](#)
- [Auto Volume](#)
- [Sound Feedback](#) [Try Now](#)
- [Reset Sound](#) [Try Now](#)

 Standard audio signals are sampled at 48 kHz while HD audio signals are sampled at 96 kHz.

 Some S/PDIF receivers may not be compatible with HD audio format.

Using the Sound Support Functions

Configure the sound settings for your TV.

Selecting speakers

[Home](#) > [Settings](#) > [Sound](#) > [Sound Output](#) Try Now

You can select which speakers the TV uses for audio output.

 External speakers may not be controlled with the remote control. When an external speaker is enabled, some sound menus are not supported.

Listening to the TV through a Samsung audio device that supports the Wi-Fi function

For more information about how to connect and use a Samsung audio device that supports the Wi-Fi function, refer to its user manual.

 This function may not be supported depending on the model or geographical area.

Using Samsung audio devices that support the Wi-Fi function to create a surround sound configuration

[Home](#) > [Settings](#) > [Sound](#) > [Wi-Fi Speaker Surround Setup](#) Try Now

If you've connected one or more Samsung wireless audio devices that support the Wi-Fi function to the TV, you can create an optimal sound set up by configuring the surround effect settings. You can select any of the surround sound configurations, with or without a sound bar.

A surround sound configuration can be used if all of the following conditions are met:

- Two or more Samsung wireless speakers of the same type must be connected to the same wireless network.
- The Samsung audio devices that supports the Wi-Fi function, must be connected to the same wireless network as the TV.

 The surround sound configurations with a sound bar may not be supported depending on the product.

 If you activate the [Screen Mirroring](#) function while using the Samsung audio devices that supports the Wi-Fi function, the connection is disconnected.

 Lip syncs with mismatched video and audio time codes may occur depending on the device type.

System and Support

You can configure system and support settings such as clock, timers, energy usage and software updates.

Using the Time Functions and the Timers

Set the current time and use the timer function.

Setting the current time

[Home](#) > [Settings](#) > [General](#) > [System Manager](#) > [Time](#) Try Now

You can set the **Clock** manually or automatically. Once the **Clock** is set, you can view the current time on the TV anytime.

You must set the clock in the following cases:

- The power cable is disconnected and then connected.
- The **Clock Mode** is changed from **Auto** to **Manual**.
- The TV is not connected to the Internet.
- No broadcast signals are received.

Setting the clock automatically

[Home](#) > [Settings](#) > [General](#) > [System Manager](#) > [Time](#) > [Clock](#) > [Clock Mode](#) > [Auto](#)

 This function works only when the TV is connected to the Internet or is receiving digital broadcasts through an antenna connected.

 The accuracy of the time information received may differ with the channel and signal.

 When watching TV by connecting a cable box or satellite box to the HDMI or Component port, you must set the current time manually.

Setting the clock manually

[Home](#) > [Settings](#) > [General](#) > [System Manager](#) > [Time](#) > [Clock](#) > [Clock Mode](#) > [Manual](#)

When **Clock Mode** is set to **Manual**, you can directly enter the current time. Select the **Date** and **Time** by using the arrow buttons on the remote control.

Adjusting the clock for DST and time zone

[Home](#) > [Settings](#) > [General](#) > [System Manager](#) > [Time](#) > [Clock](#) > [Time Zone](#)

Sets the right time by setting Daylight Savings Time (DST) and your local time zone.

 This function is only available when the **Clock Mode** is set to **Auto**.

- **GMT**
Selects your time zone.
- **DST**
Automatically adjust for Daylight Saving Time (DST).

 This function is only available when the **Clock Mode** is set to **Auto**.

Changing the current time

[Home](#) > [Settings](#) > [General](#) > [System Manager](#) > [Time](#) > [Clock](#) > [Time Offset](#)

Time Offset adjusts the time through a network connection.

This function is available only when all the following conditions are met:

 **Clock Mode** is set to **Auto**, the TV is connected to the Internet through a local area network, and the TV fails to receive time information through normal broadcast signals.

Using the timers

Using the sleep timer

[Home](#) > [Settings](#) > [General](#) > [System Manager](#) > [Time](#) > [Sleep Timer](#)

You can use this function to automatically shut off the TV after a pre-set period of time. You can set the sleep timer to up to 180 minutes to automatically turn off the TV.

 This function may not be supported depending on the model or geographical area.

Turning off the TV using the off timer

[Home](#) > [Settings](#) > [General](#) > [System Manager](#) > [Time](#) > [Off Timer](#)

You can set **Off Timer** to shut off the TV automatically at a specific time. **Off Timer** is only available if the **Clock** has been set.

 This function may not be supported depending on the model or geographical area.

Using the Auto Protection Time and Energy Saving Functions

Setting the Auto Protection Time and reduce the TV's energy consumption.

Setting the Auto Protection Time

[Home](#) > [Settings](#) > [General](#) > [System Manager](#) > [Auto Protection Time](#) Try Now

Activate a screensaver when your TV displays a still image for two hours or more.

 This function may not be supported depending on the model or geographical area.

Reducing the energy consumption of the TV

[Home](#) > [Settings](#) > [General](#) > [Eco Solution](#)

You can adjust the brightness level of the TV, reduce overall power consumption, and prevent overheating.

 This function may not be supported depending on the model or geographical area.

- **Ambient Light Detection**

Automatically adjusts the brightness level of the TV, according to the ambient light level, to reduce power consumption. If the **Ambient Light Detection** has adjusted the screen brightness to a too bright or dark level, you can select **Minimum Backlight** to manually adjust the minimum screen brightness.

- **Minimum Backlight**

When the **Ambient Light Detection** is turned on, you can manually adjust the minimum brightness of the TV screen to consider the brightness level of the surroundings. This function acts only when the value is less than the setting in [Home](#) > [Settings](#) > [Picture](#) > [Expert Settings](#) > [Backlight](#).

- **Energy Saving Mode**

Allows you to select a brightness setting from the list to reduce the TV's power consumption.

- **Motion Lighting**

Adjusts the brightness in response to on-screen movements to reduce power consumption.

- **Auto Power Off**

Automatically turns off the TV to reduce unnecessary power consumption if there is no operation for 4 hours.

Updating the TV's Software

View your TV's software version and update it if necessary.

[Home](#) > [Settings](#) > [Support](#) > [Software Update](#) [Try Now](#)

Updating the TV's software to the latest version

⚠ DO NOT turn off the TV's power until the update is complete. The TV will turn off and on automatically after completing the software update. Video and audio settings will be reset to their defaults after a software update.

Updating through the Internet

[Home](#) > [Settings](#) > [Support](#) > [Software Update](#) > [Update Now](#) [Try Now](#)

 Updating from the Internet requires an active Internet connection.

Updating through a USB device

[Home](#) > [Settings](#) > [Support](#) > [Software Update](#) > [Update Now](#)

After downloading the update file from the Samsung website and storing it on a USB device, connect the USB device to the TV to update.

 To update using a USB flash drive, download the update package from Samsung.com to your computer. Then, save the update package in the USB device's top-level folder. Otherwise, the TV will not be able to locate the update package.

Updating the TV automatically

[Home](#) > [Settings](#) > [Support](#) > [Software Update](#) > [Auto update](#) [Try Now](#)

If the TV is connected to the Internet, you can have the TV update its software automatically while you are watching the TV. When the background update is completed, it is applied the next time the TV is turned on.

If you agree to the Smart Hub terms and conditions, **Auto update** is set to **On** automatically. If you want this function disabled, use the Select button to turn it off.

 This function may take a longer time if another network function is running concurrently.

 This function requires an Internet connection.

Protecting the TV from Hacking and Malicious Code

Protect your TV from hacking attempts and malicious code.

[Home](#) > [Settings](#) > [General](#) > [System Manager](#) > [Smart Security](#) Try Now

You can use [Smart Security](#) to protect the TV from hacking and malicious code when it is connected to the Internet.

Scanning the TV and connected storage for malicious code

[Home](#) > [Settings](#) > [General](#) > [System Manager](#) > [Smart Security](#) > [Scan](#)

If malicious code is found, the results of the scan will appear on the screen. This result window displays all malicious code found. You can quarantine (isolate) the code. Quarantining prevents it from executing.

1. Select all the malicious code to quarantine.
2. Select [Isolate](#).

The selected malicious code is relocated to the [Isolated List](#).

 The [Isolated List](#) displays all quarantined malicious codes.

Using Other Functions

[View other functions.](#)

Running the accessibility functions

[Home](#) > [Settings](#) > [General](#) > [Accessibility](#) Try Now

Running Accessibility Shortcuts

The [Accessibility Shortcuts](#) provide access to the accessibility functions. To display the [Accessibility Shortcuts](#), press the AD/SUBT. button. You can easily turn on or turn off the functions such as [Voice Guide](#), [Audio Description](#), [High Contrast](#), [Enlarge](#), [Learn TV Remote](#), [Menu Learning Screen](#), [Subtitle](#), etc.

 Even if the [Voice Guide](#) is set to [Off](#) or muted, the voice guide for [Accessibility Shortcuts](#) is enabled.

 The menus may not appear depending on the model or geographical area.

Enabling voice guides for the visually impaired

[Home](#) > [Settings](#) > [General](#) > [Accessibility](#) > [Voice Guide Settings](#) Try Now

You can activate voice guides that describe the menu options aloud to aid the visually impaired. To activate this function, set **Voice Guide** to **On**. With **Voice Guide** on, the TV provides voice guides for channel change, volume adjust, information on current and upcoming programmes, schedule viewing, other TV functions, various content in the **Internet**, and in **Search**.

You can go to **Voice Guide** and press the Select button to turn the function on or off.

 The **Voice Guide** is provided in the language that is specified on the **Language** screen. However, some languages are not supported by **Voice Guide** even though they are listed in the **Language** screen. **English** is always supported.

 For more information about the TV language settings, refer to "[Changing the menu language](#)".

Changing the volume, speed, and pitch of the Voice Guide

You can configure the volume, speed, and pitch of the voice guide.

Audio Description

[Home](#) > [Settings](#) > [General](#) > [Accessibility](#) > [Audio Description Settings](#) Try Now

You can use the Audio Stream for the Audio Description which is sent along with the Main audio from the broadcaster. Adjust the audio description volume using **Audio Description Volume**.

 This function is only available on digital channels.

- **Audio Description**
Turns the audio description function on or off.
- **Audio Description Volume**
Adjusts the audio description volume.

White text on black background (high contrast)

[Home](#) > [Settings](#) > [General](#) > [Accessibility](#) > [High Contrast](#) [Try Now](#)

You can change Smart Hub and setting menu screens to white text on a black background or change the transparent TV menus to opaque so that text can be more easily read. To activate this function, set [High Contrast](#) to [On](#).

 If [High Contrast](#) is on, some [Accessibility](#) menus are not available.

Enlarging the font (for the visually impaired)

[Home](#) > [Settings](#) > [General](#) > [Accessibility](#) > [Enlarge](#) [Try Now](#)

You can enlarge the size of the font on the screen. To activate this function, set [Enlarge](#) to [On](#).

Learning about the remote control (for the visually impaired)

[Home](#) > [Settings](#) > [General](#) > [Accessibility](#) > [Learn TV Remote](#) [Try Now](#)

This function helps individuals with a visual impairment to learn the positions of the buttons on the remote control. When this function is activated, you can press a button on the remote control and the TV will tell you its name. Press the  or EXIT button twice to exit [Learn TV Remote](#).

 This function is only available when [Voice Guide](#) is enabled.

Learning about the TV menu

[Home](#) > [Settings](#) > [General](#) > [Accessibility](#) > [Menu Learning Screen](#) [Try Now](#)



Learn the menus on the TV screen. Once enabled, your TV will tell you the structure and features of the menus you select.

 This function is only available when [Voice Guide](#) is enabled.

Watching TV broadcasts with subtitles

[Home](#) > [Settings](#) > [General](#) > [Accessibility](#) > [Subtitle Settings](#) Try Now

Set **Subtitle** to **On**. Then you can watch the programme with the subtitle displayed.

-  This function may not be supported depending on the model or geographical area.
-  The TV cannot control or modify DVD or Blu-ray subtitles. To control DVD or Blu-ray subtitles, use the sub-title feature of the DVD or Blu-ray player and the player's remote control.

- **Subtitle**
Turns on or off the subtitle.
- **Subtitle Mode**
Sets the subtitle mode.
- **Subtitle Language**
Sets the subtitle language.

 The TV cannot control or modify DVD or Blu-ray subtitles. To control DVD or Blu-ray subtitles, use the subtitle feature of the DVD or Blu-ray player and the player's remote control.

Selecting the broadcasting subtitle language

You can select the default subtitle language. The list may vary depending on the broadcast.

- **Primary Subtitle Language**
Sets the primary subtitle language.
- **Secondary Subtitle Language**
Sets the secondary subtitle language.

Configuring advanced system settings

[Home](#) > [Settings](#) > [General](#) > [System Manager](#) Try Now

Changing the menu language





[Home](#) > [Settings](#) > [General](#) > [System Manager](#) > [Language](#) Try Now

Setting up a password

[Home](#) > [Settings](#) > [General](#) > [System Manager](#) > [Change PIN](#) Try Now

The PIN input window appears. Enter a PIN. Enter it again to confirm it. The default PIN is "0000" (for France and Italy: "1111").

 If you forget your PIN, you can reset it with your remote control. With the TV turned on, press the following buttons on the remote control in the order shown to reset the PIN to "0000" (for France and Italy: "1111").

Select  button. >  (Volume Up) > Select RETURN button. >  (Volume Down) > Select RETURN button. >  (Volume Up) > Select RETURN button.

Selecting Usage or Retail Mode

[Home](#) > [Settings](#) > [General](#) > [System Manager](#) > [Usage Mode](#) Try Now

You can use the TV for retail environments by setting **Usage Mode** to **Retail Mode**.

 For all other uses, select **Home Mode**.

 With **Retail Mode**, some functions are disabled, and the TV automatically resets itself after a preset amount of time.

Restoring the TV to the factory settings

[Home](#) > [Settings](#) > [Support](#) > [Self Diagnosis](#) > [Reset](#) Try Now

You can restore all TV settings (excluding the Internet and network settings) to the factory defaults.

1. Select **Reset**. The security PIN entry window appears.
2. Enter the security PIN, and then select **Yes**. All settings are then reset. The TV turns off and on again automatically and displays the **Start Setup** screen.

 For more information on **Start Setup**, refer to the user manual that came with the TV.



HbbTV

Access services from entertainment providers, online providers and CE manufactures through HbbTV.

 This function may not be supported depending on the model or geographical area.

 Some channels may not include the HbbTV service.

In some countries, HbbTV is disabled by default. In this case, HbbTV can be used by installing the HbbTV application (the HbbTV Installer Application) from Samsung APPS.





To set the HbbTV automatic start to on or off, access  >  **Settings** > **Broadcasting** > **Expert Settings** > **HbbTV Settings** and set **HbbTV** to on or off. (Depending on the geographical area.)

If you want this function enabled or disabled, use the Select button to turn it on or off.

- An application on HbbTV may malfunction temporarily depending on the circumstances of the broadcast station or application provider.
- An application on HbbTV usually operates only when the TV is connected to an external network. The application may malfunction depending on the network conditions.
- When the HbbTV application is installed and the broadcasting programme supports HbbTV, a red button appears on the screen.
- It is possible to use both Digital Teletext and Traditional Teletext in several limited channels by pressing the TTX/MIX button on the remote control in a toggling manner.
- When you press the TTX/MIX button once in HbbTV mode, digital TTX mode of HbbTV is activated.
- When you press the TTX/MIX button twice in HbbTV mode, Traditional Teletext mode is activated.

Using a TV Viewing Card (“CI or CI+ Card”)

Watches paid channels by inserting your TV viewing card into the COMMON INTERFACE slot.

-  The 2 CI card slots may not be supported depending on the model.
-  Turn the TV off to connect or disconnect a “CI or CI+ Card”.
-  The TV Viewing Card (“CI or CI+ Card”) may not supported depending on the model.
-  Depending on the model or geographical area.
-  The image may differ depending on the model.

Connecting the “CI or CI+ Card” via COMMON INTERFACE slot with the CI CARD Adapter

-  Only for models with Common interface slot.

Attaching the CI CARD Adapter via COMMON INTERFACE slot

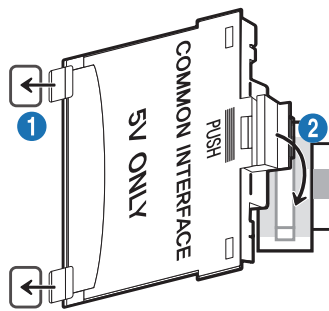

To attach the CI CARD Adapter to the TV, follow these steps:



- 1** Insert the CI CARD Adapter into the two holes on the back of TV.
 -  Please locate the two holes at the back of the TV next to the COMMON INTERFACE slot.
- 2** Connect the CI CARD Adapter to the COMMON INTERFACE slot on the back of TV.

Connecting the “CI or CI+ Card”

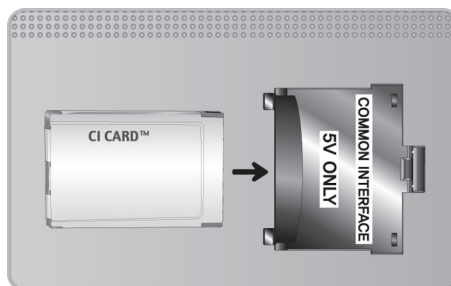
Connect the “CI or CI+ Card” to the COMMON INTERFACE slot as shown in the image below.



Connecting the “CI or CI+ Card” via COMMON INTERFACE slot





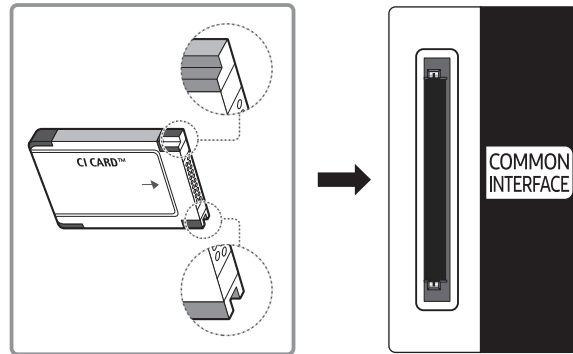



-  Depending on the model or geographical area.
-  The image may differ depending on the model.
-  Only for models with Common interface slot.

Connect the “CI or CI+ Card” to the COMMON INTERFACE slot as shown in the image below.









Using the “CI or CI+ Card”

To watch paid channels, the “CI or CI+ CARD” must be inserted.



- Samsung TV follow up CI+ 1.4 standard. When TV product display the pop-up message, it may happen due to CI+ 1.4 Version inconsistency. If you have a problem, please contact Samsung Call Centre.
-  Your Samsung TV conforms to the CI+ 1.4 standards.
-  Where a CI+ Common Interface module is incompatible with this device then please remove the module and contact the CI+ operator for assistance.
- If you don't insert the “CI or CI+ CARD”, some channels will display the pop-up message.
- The pairing information containing a telephone number, the “CI or CI+ CARD” ID, the Host ID, and other information will be displayed in about 2~3 minutes. If an error message is displayed, please contact your service provider.
- When the configuration of channel information has finished, the message “Updating Completed” is displayed, indicating the channel list is updated.
-  You must obtain a “CI or CI+ CARD” from a local cable service provider.
-  When removing the “CI or CI+ CARD”, carefully pull it out with your hands since dropping the “CI or CI+ CARD” may cause damage to it.
-  Insert the “CI or CI+ CARD” in the direction marked on the card.
-  The location of the COMMON INTERFACE slot may be different depending on the model.
-  “CI or CI+ CARD” is not supported in some countries and regions; check with your authorised dealer.
-  If you have any problems, please contact a service provider.
-  Insert the “CI or CI+ CARD” that supports the current aerial settings. If not, the screen may not look normal.

Teletext Feature

Learn how to use Teletext and run the functions provided by Teletext Service.

-  This function is available only in the channel that supports the teletext service.
-  This function may not be supported depending on the model or geographical area.
-  To enter the Teletext feature, press the  TTX/MIX button.
-  To exit from the Teletext feature, press the  TTX/MIX button on the remote control until live TV appears.

The index page of the Teletext service gives you information on how to use the Service. For Teletext information to be displayed correctly, channel reception must be stable. Otherwise, information may be missing or some pages may not be displayed.

-  You can change Teletext pages by select numeric using your remote control.
-  On the standard remote control, the Teletext function icons are printed on some remote control buttons. To run a Teletext function, find its icon printed on a remote control button, and then press the found button.

 TTX/MIX

Full TTX / Double TTX / Mix / Live TV: The teletext mode is activated in the channel that is being watched. Each time you press the  TTX/MIX button, the teletext mode changes in the order of **Full TTX** → **Double TTX** → **Mix** → **Live TV**.

- **Full TTX:** The teletext mode appears on the full screen.
- **Double TTX:** The teletext mode appears on the half screen along with the currently viewed channel on the other half.
- **Mix:** The teletext mode appears transparently on the currently viewed channel.
- **Live TV:** It returns to the live TV screen.

Colour buttons (red, green, yellow, blue): If the FASTEXT system is used by the broadcasting company, the different topics on a Teletext page are colour-coded and can be selected by coloured buttons. Press the colour corresponding to the topic of your choice. A new colour coded page appears. Items can be selected in the same way. To display the previous or next page, select corresponding coloured button.

 SETTINGS

Index: Displays the index (contents) page at any time while you are viewing Teletext.

 PRE-CH

Sub Page: Displays the available sub-page.

 SOURCE

List/Flof: Selects the Teletext mode. If pressed during LIST mode, switches the mode to List save mode. In List save mode, you can save a Teletext page into a list using the  (Store) button.

 CH LIST

Store: Stores the Teletext pages.

 CH 

Page Up: Displays the next Teletext page.

 CH 

Page Down: Displays the previous Teletext page.

 INFO

Reveal/Conceal: Displays or hides the hidden text (answers to quiz games, for example). To display the normal screen, press it again.

 E-MANUAL

 Depending on the model or geographical area.

Size: Displays the teletext on the upper half of the screen in double-size. To move the text to the lower half of the screen, press it again. For normal display, press it once again.

 RETURN

Hold: Holds the display at the current page, in the case that there are several secondary pages that follow automatically. To undo, press it again.

 EXIT

Cancel: Shrinks the Teletext display to overlap with the current broadcast.

Typical Teletext page

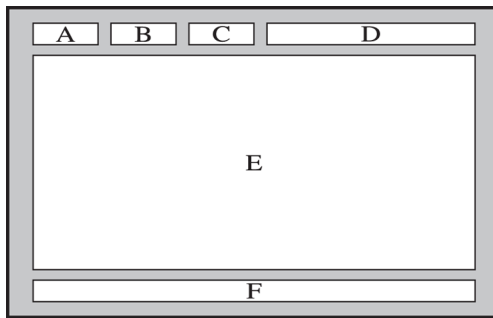

Part	Contents
A	Selected page number.
B	Broadcasting channel identity.
C	Current page number or search indications.
D	Date and time.
E	Text.
F	Status information. FASTEXT information.

Troubleshooting

If you have a problem with your TV, you can access various solutions while watching TV. If your problem is not addressed in the Troubleshooting section, contact the Samsung Call Centre.

Getting Support

Get help directly from Samsung if you have a problem with your TV.

Getting support through Remote Management

 >  **Settings** > **Support** > **Remote Management** Try Now

After consenting to our service agreement, you can use **Remote Management** to access Remote Support and have a Samsung service technician diagnose your TV, correct problems, and update your TV's software remotely via the web. You can also turn **Remote Management** on and off.

 This function requires an Internet connection.

 You can also start **Remote Management** function by pressing and holding the  button for 5 or more seconds.



What is Remote Support?

Samsung Remote Support service offers you one-on-one support with a Samsung Technician who can remotely:

- **Diagnose** your TV
- **Adjust the TV settings** for you
- Perform a factory reset on your TV
- Install recommended **firmware updates**

How does Remote Support Work?



You can easily get Samsung Remote Support service for your TV:

1. Call the Samsung Contact Centre and ask for remote support.
2. Open the menu on your TV and go to the **Support** section. ( >  **Settings** > **Support**)
3. Select **Remote Management**, then read and agree to the service agreements. When the PIN screen appears, provide the PIN number to the technician.
4. The technician will then access your TV.

Finding the contact information for service

[Home](#) > [Settings](#) > [Support](#) > [About This TV](#) [Try Now](#)



You can view the address of the Samsung website, the call centre phone number, your TV's model number, your TV's software version, Open Source Licence and other information you may need to get service support from a Samsung call agent or the Samsung website.

-  You can also view information by scanning the QR code of your TV.
-  You can also start this function by pressing and holding the  (Play) button for 5 or more seconds. Continue holding the button until the customer information pop-up window appears.

Requesting service

[Home](#) > [Settings](#) > [Support](#) > [Request Support](#) [Try Now](#)

You can request service when you encounter a problem with the TV. Select the item matching the problem that you encountered, and then select [Request Now](#) or [Schedule Appointment](#) > [Request](#) > [Send](#). Your service request will be registered. The Samsung Contact Centre will contact you to set up or confirm your service appointment.

-  You must agree to the terms and conditions for the service request.
-  This function may not be supported depending on the geographical area.
-  This function requires an Internet connection.

Diagnosing TV operational issues

You can diagnose issues with your TV and Smart Hub and run reset functions.

[Home](#) > [Settings](#) > [Support](#) > [Self Diagnosis](#) [Try Now](#)

You can use the [Picture Test](#) to help diagnose video issues and the [Sound Test](#) to diagnose sound issues. You can also view signal strength information for over-the-air digital signals, test the Smart Hub Internet connection, and run the Smart Hub and TV factory reset functions.

- [Start Picture Test](#)
- [Start Sound Test](#)
- [Signal Information](#)
- [Start Smart Hub Connection Test](#)
- [Reset Smart Hub](#)
- [Reset](#)

There Is a Problem with the Picture



When the TV has trouble with the picture, these steps may help resolve the problem.



Testing the picture

[Home](#) > [Settings](#) > [Support](#) > [Self Diagnosis](#) > [Start Picture Test](#) Try Now

Before you review the list of problems and solutions below, use [Start Picture Test](#) to determine if the problem is caused by the TV. [Start Picture Test](#) displays a high definition picture you can examine for flaws or faults.

The problem	Try this!
Flickering and Dimming	<p>If your Samsung Television is flickering or dimming sporadically, you may need to disable some of the energy efficiency features.</p> <p>Disable Ambient Light Detection, Energy Saving Mode, or Motion Lighting.</p> <ul style="list-style-type: none"> Home > Settings > General > Eco Solution > Ambient Light Detection Home > Settings > General > Eco Solution > Energy Saving Mode Home > Settings > General > Eco Solution > Motion Lighting <p> This function may not be supported depending on the model or geographical area.</p>
Component Connections/ Screen Colour	<p>If the colour on your TV screen is not correct or the black and white colours are off, run Start Picture Test.</p> <ul style="list-style-type: none"> Home > Settings > Support > Self Diagnosis > Start Picture Test <p>If the test results indicate that the problem is not caused by the TV, do the following:</p> <ul style="list-style-type: none"> Confirm that the video input connectors are connected to the correct external device video output connectors. Check the other connections as well. If the TV is connected to an external device via a component cable, confirm that the Pb, Pr, and Y jacks are plugged into their proper connectors.
Screen Brightness	<p>If the colours on your Samsung TV are correct but just a little too dark or bright, try adjusting the following settings first.</p> <ul style="list-style-type: none"> Home > Settings > Picture > Expert Settings > Backlight Home > Settings > Picture > Expert Settings > Contrast Home > Settings > Picture > Expert Settings > Brightness Home > Settings > Picture > Expert Settings > Sharpness Home > Settings > Picture > Expert Settings > Colour Home > Settings > Picture > Expert Settings > Tint (G/R)

The problem	Try this!
Unwanted Powering Off	<p>If your TV appears to turn off by itself, try disabling some of the TV's energy efficiency functions.</p> <p>See if Sleep Timer has been enabled. The Sleep Timer automatically turns the TV off after a specified period of time.</p> <ul style="list-style-type: none"> • Home > Settings > General > System Manager > Time > Sleep Timer <p>If the Sleep Timer has not been enabled, see if Auto Power Off or Off Timer has been enabled and disable it.</p> <ul style="list-style-type: none"> • Home > Settings > General > Eco Solution > Auto Power Off <p> This function may not be supported depending on the model or geographical area.</p> <ul style="list-style-type: none"> • Home > Settings > General > System Manager > Time > Off Timer
Problems Powering On	<p>If you are having problems powering on your TV, there are a number of things to check before calling the service department.</p> <p>Confirm that the TV's power cord is connected correctly at both ends and that the remote control is operating normally.</p> <p>Make sure that the antenna cable or cable TV cable is firmly connected.</p> <p>If you have a cable box or satellite box, confirm that it is plugged in and turned on.</p>
Unable to find a Channel	<p>If your TV is not connected to a cable box or satellite box, run Auto Tuning.</p> <ul style="list-style-type: none"> • Home > Settings > Broadcasting > (Auto Tuning Settings) > Auto Tuning <p> The Auto Tuning Settings may not appear depending on the model or geographical area.</p>
The TV image does not look as good as it did in the store.	<p>Store displays are tuned to a digital HD channel.</p> <p>If you have an analogue cable box or satellite box, upgrade to a digital cable box or satellite box. Use HDMI or Component cables to deliver HD (high definition) picture quality.</p> <p>Many HD channels are upscaled from SD (Standard Definition) content. Look for a channel that is broadcasting HD content.</p> <ul style="list-style-type: none"> • Cable/Satellite Subscribers: Try HD channels from the channel lineup. • Terrestrial/Cable Antenna Connection: Try HD channels after running the Auto Tuning function. • Home > Settings > Broadcasting > (Auto Tuning Settings) > Auto Tuning <p> The Auto Tuning Settings may not appear depending on the model or geographical area.</p> <p>Adjust the cable box or satellite box's video output resolution to 1080i or 720p.</p>

The problem	Try this!
The picture is distorted.	<p>The compression of video content may cause picture distortions, especially in fast moving pictures from sports programmes and action movies.</p> <p>If the signal reception is weak or poor, screen distortion may be visible but it is not a malfunction.</p> <p>Mobile phones used close to the TV (within 1 m) may cause noise on analogue and digital channels.</p>
The colour is wrong or missing.	<p>If you're using a Component connection, make sure that the Component cables are connected to the correct jacks. Incorrect or loose connections may cause colour problems or a blank screen.</p>
The colour is poor or the picture is not bright enough.	<p>Go to Picture and then adjust the Picture Mode, Brightness, Sharpness, and Colour settings.</p> <ul style="list-style-type: none"> • Home > Settings > Picture > Picture Mode • Home > Settings > Picture > Expert Settings > Brightness • Home > Settings > Picture > Expert Settings > Sharpness • Home > Settings > Picture > Expert Settings > Colour <p>See if Energy Saving Mode has been enabled.</p> <ul style="list-style-type: none"> • Home > Settings > General > Eco Solution > Energy Saving Mode <p> This function may not be supported depending on the model or geographical area.</p> <p>Try resetting the picture.</p> <ul style="list-style-type: none"> • Home > Settings > Picture > Expert Settings > Reset Picture
There is a dotted line on the edge of the screen.	<p>Change Picture Size to 16:9 Standard.</p> <ul style="list-style-type: none"> • Home > Settings > Picture > Picture Size Settings > Picture Size > 16:9 Standard
The picture is black and white.	<p>If you are using AV or analogue equipment, disconnect the adapter from the Component (Blue) input port on the TV and connect it to the AV (Yellow) input port.</p> <p> The Component or AV input port may not be provided depending on the model or geographical area.</p> <p> Component adapter, AV adapter may not provided depending on the model or geographical area.</p>

 If the test picture does not appear or there is noise or distortion, the TV may have a problem. Contact Samsung's Call Centre for assistance.

 If the test picture is displayed properly, there may be a problem with an external device. Please check the connections.

 If the problem persists, check the signal strength or refer to the external device's user manual.

I Can't Hear the Sound Clearly

When the TV has difficulties with sound, these steps may help resolve the problem.

Testing the sound











[Home](#) > [Settings](#) > [Support](#) > [Self Diagnosis](#) > [Start Sound Test](#) [Try Now](#)

If the TV plays the [Start Sound Test](#) melody without distortion, there may be a problem with an external device or the broadcast signal's strength.

The problem	Try this!
There is no sound or the sound is too low at maximum volume.	Check the volume control of your TV, and then check the volume control of the external device (cable box or satellite box, DVD, Blu-ray, etc.) connected to your TV.
The picture is good but there is no sound.	<p>Set Sound Output to TV Speaker.</p> <ul style="list-style-type: none">• Home > Settings > Sound > Sound Output <p>If you are using an external device, check the device's audio output option. For example, you may need to change your cable box's audio option to HDMI if the box connected to your TV is using an HDMI cable.</p> <p>To listen to computer sound, connect an external speaker to the computer's audio output connector.</p> <p>If your TV has a headphone jack, make sure there is nothing plugged into it.</p> <p>Reboot the connected device by disconnecting and then reconnecting the device's power cable.</p>
No sound is heard.	<p>Check whether the Digital Output Audio Format is set to Dolby Digital+. If you are using a receiver that does not support Dolby Digital Plus, you will hear no sound when you select Dolby Digital+.</p> <ul style="list-style-type: none">• Home > Settings > Sound > Expert Settings > Digital Output Audio Format > Dolby Digital+
The speakers are making an odd sound.	<p>Run Start Sound Test.</p> <ul style="list-style-type: none">• Home > Settings > Support > Self Diagnosis > Start Sound Test <p>Make sure that the audio cable is connected to the correct audio output connector on the external device.</p> <p>For antenna or cable connections, check the signal information. A low signal level may cause sound distortions.</p>

There Is a Problem with the Broadcast

When the TV has difficulties receiving broadcasts, these steps may help resolve the problem.

The problem	Try this!
<p>“Weak or No Signal” displayed in TV mode/cannot find channel.</p>	<p>Make sure the antenna cable is connected securely to the TV.</p> <p>Select  >  Source to confirm that the correct input source has been selected.</p> <p>If the TV is not connected to a cable box or satellite box, run Auto Tuning to search for channels.</p> <ul style="list-style-type: none"> •  >  Settings > Broadcasting > (Auto Tuning Settings) > Auto Tuning <p> The Auto Tuning Settings may not appear depending on the model or geographical area.</p>
<p>The TV is not receiving all channels.</p>	<p>Confirm that the coaxial cable is securely connected to the TV.</p> <p>Run Start Setup or Auto Tuning.</p> <ul style="list-style-type: none"> •  >  Settings > Broadcasting > (Auto Tuning Settings) > Auto Tuning <p> The Auto Tuning Settings may not appear depending on the model or geographical area.</p>
<p>There are no subtitles with digital channels.</p>	<p>Go to Subtitle and change the Subtitle Mode.</p> <ul style="list-style-type: none"> •  >  Settings > General > Accessibility > Subtitle Settings > Subtitle > Subtitle Mode. <p>Some channels may not have subtitle data.</p>
<p>The picture is distorted.</p>	<p>The compression of the video content may cause picture distortions. This is especially true with fast moving pictures from sports programmes and action movies.</p> <p>A weak signal can cause picture distortions. This is not a problem with the TV.</p>
<p>The picture quality is low.</p>	<p>Select high definition (HD) channels or programmes.</p>

My Computer Won't Connect

When the TV has difficulties connecting to a PC, these steps may help resolve the problem.

The problem	Try this!
The "Mode Not Supported" message appears.	Set your PC's output resolution so it matches a resolution supported by the TV.
The video is OK but there is no audio.	If you are using an HDMI connection, check the audio output setting on your PC. If you are using an HDMI-to-DVI cable, a separate audio cable is required. Note that the HDMI-to-DVI connection is only supported by the HDMI (DVI) port and does not transmit audio. To listen to the computer sound, connect external speakers to the audio output connection of the computer.

The TV Won't Connect to the Internet

When the TV has difficulties connecting to the Internet, these steps may help resolve the problem.

The problem	Try this!
The TV cannot connect to your network or apps (for Internet compatible models only).	Make sure the TV has a network connection. <ul style="list-style-type: none">• Home > Settings > General > Network > Network Status Contact your Internet service provider.
The wireless network connection failed.	Confirm your wireless modem/router is on and connected to the Internet.
The wireless network signal is too weak.	Position your wireless router, modem router, or access point in a central location. Avoid putting it in a corner. Use a wireless repeater to get an instant boost in your wireless signal strength. Place the repeater halfway between your wireless router and your TV.

Anynet+ (HDMI-CEC) Isn't Working

When Anynet+ (HDMI-CEC) isn't working, these steps may help resolve the problem.

The problem	Try this!
Anynet+ does not work.	<p>Confirm that the device is an Anynet+ device. The Anynet+ system supports Anynet+ devices only.</p> <p>Check if the power cord of the Anynet+ device is properly connected.</p> <p>Check the cable connections of the Anynet+ device.</p> <p>Go to Anynet+ (HDMI-CEC) and see if Anynet+ (HDMI-CEC) has been set to On.</p> <ul style="list-style-type: none"> • Home > Settings > General > External Device Manager > Anynet+ (HDMI-CEC) <p>Anynet+ may not function when some other functions are active, including Channel Search, Smart Hub, Initial Setup, etc.</p> <p>If you have disconnected and then reconnected the HDMI cable, scan for devices again or turn your TV off and on.</p>
I want to start Anynet+.	<p>Move the focus to the Anynet+ device at Home > Source, press the up directional button to move to Anynet+, and then press the Select button.</p> <p>Check if the Anynet+ device is properly connected to the TV, and then select Anynet+ (HDMI-CEC) menu to see if Anynet+ (HDMI-CEC) is set to On.</p> <ul style="list-style-type: none"> • Home > Settings > General > External Device Manager > Anynet+ (HDMI-CEC)
I want to exit Anynet+.	<p>Set Anynet+ (HDMI-CEC) to Off.</p> <ul style="list-style-type: none"> • Home > Settings > General > External Device Manager > Anynet+ (HDMI-CEC)
The message "Connecting to Anynet+ device..." or "Disconnecting from Anynet+ device" appears on the screen.	<p>You cannot use the remote control when the TV is configuring Anynet+ or switching to a viewing mode. Use the remote control after the TV has completed the Anynet+ configuration or has switched to a viewing mode.</p>
The Anynet+ device won't play.	<p>You cannot use the play function when Start Setup is in progress.</p>

The problem	Try this!
<p>The connected device is not displayed.</p>	<p>Check whether the device supports Anynet+.</p> <p>Check whether the HDMI cable is properly connected.</p> <p>Go to Anynet+ (HDMI-CEC) and see if Anynet+ (HDMI-CEC) has been set to On.</p> <ul style="list-style-type: none"> • Home > Settings > General > External Device Manager > Anynet+ (HDMI-CEC) <p>Scan for Anynet+ devices again.</p> <p>Anynet+ devices must be connected to the TV using an HDMI cable. Make sure the device is connected to your TV with an HDMI cable. Some HDMI cables may not support Anynet+.</p> <p>If the connection is terminated because there has been a power failure or the HDMI cable has been disconnected, please scan for the device again.</p>
<p>The TV audio is not being played through the AV receiver.</p>	<p>Connect an optical cable to the TV and the AV receiver.</p> <p>ARC enables the TV to output digital sound via the HDMI (ARC) port.</p> <p>However, ARC is only available when the TV is connected to an AV receiver that supports ARC.</p>

I Have Trouble Launching/Using Apps

When apps aren't working, these steps may help resolve the problem.

The problem	Try this!
<p>I launched an app, but it's in English. How can I change the language?</p>	<p>Languages supported by the app may be different from the user interface language. The ability to change the language depends on the service provider.</p>
<p>My application is not working.</p>	<p>Check with the service provider.</p> <p>Refer to the Help section on the application service provider's website.</p>

My File Won't Play

When files aren't playing, this may help resolve the problem.

The problem	Try this!
Some files can't be played.	This problem may occur with high-bitrate files. Most files can be played back, but you might experience problems with high-bitrate files.

I Want to Reset the TV

Initialise the settings to factory defaults.

Reset	Path	Description
Reset Settings	Home > Settings > Support > Self Diagnosis > Reset	Resets Picture, Sound, Broadcasting , and all other settings, except for the network settings, to the default settings.
Reset Smart Hub	Home > Settings > Support > Self Diagnosis > Reset Smart Hub	Resets all Smart Hub settings to their factory defaults and deletes all information related to Samsung accounts, linked service accounts, Smart Hub service agreements, and Smart Hub applications.
Reset Picture	Home > Settings > Picture > Expert Settings > Reset Picture	Resets current picture settings.
Reset Sound	Home > Settings > Sound > Expert Settings > Reset Sound	Resets current sound settings.

Other Issues

Use these procedures to resolve other issues that may occur.

The problem	Try this!
The TV is hot.	Watching TV for an extended period of time causes the panel to generate heat. The heat from the panel is dissipated through internal vents running along the top of the TV. The bottom, however, may feel hot to the touch after extended use. Children watching TV need constant adult supervision to prevent them from touching the TV. This heat, however, is not a defect and does not affect the TV's functionality.
The picture won't display in full screen.	<p>HD channels will have black bars on either side of the screen when displaying upscaled SD (4:3) content.</p> <p>Black bars will appear at the top and bottom of the screen when you watch movies that have aspect ratios different from your TV.</p> <p>Adjust the picture size options on your external device or set the TV to full screen.</p> <ul style="list-style-type: none"> • Home > Settings > Picture > Picture Size Settings
The "Mode Not Supported" message appears.	The output resolution of the attached device is not supported by the TV. Check the TV's supported resolutions and adjust the external device's output resolution accordingly.
The Subtitles item in the TV is greyed out.	When an external device is connected with an HDMI or Component cable, the Subtitle function is unavailable. Adjust the subtitle setting on the external device.
The TV smells of plastic.	This smell is normal and will dissipate over time.
Signal Information under Self Diagnosis isn't activated.	<p>Verify that the current channel is a digital channel.</p> <p>Signal Information is only available for digital channels.</p> <ul style="list-style-type: none"> • Home > Settings > Support > Self Diagnosis > Signal Information
The TV is tilted to the side.	Remove the base stand from the TV and reassemble it.

The problem	Try this!
The stand is wobbly or crooked.	Make sure the indicator arrows on the stand and stand holder are properly aligned.
The remote control does not work.	The TV ships with protective stickers covering some of the sensors. Make sure all of the stickers have been removed.
The Broadcasting function has been deactivated.	<p>Broadcasting is only available when the Source is set to TV.</p> <p>Broadcasting cannot be accessed while you watch TV using a cable box or satellite box.</p>
The settings are lost after 5 minutes or every time the TV is turned off.	<p>If Usage Mode is set to Retail Mode, the TV's audio and video settings are automatically reset every 5 minutes.</p> <p>Change Usage Mode to Home Mode.</p> <ul style="list-style-type: none"> • Home > Settings > General > System Manager > Usage Mode
A POP (TV's internal banner ad) appears on the screen.	<p>Change Usage Mode to Home Mode.</p> <ul style="list-style-type: none"> • Home > Settings > General > System Manager > Usage Mode
The TV is making a popping noise.	The expansion and contraction of the TV's outer casing may cause a popping noise. This does not indicate a product malfunction. The TV is safe to use.
The TV is making a humming noise.	<p>Your TV utilises high-speed switching circuits and high levels of electrical current. Depending on the TV's brightness level, the TV may seem slightly noisier than a conventional TV.</p> <p>Your TV has undergone strict quality control procedures that meet our demanding performance and reliability requirements.</p> <p>Some noise coming from the TV is considered normal and is not an acceptable cause for an exchange or refund.</p>
The software update over the Internet has failed.	<p>Check the network connection status.</p> <ul style="list-style-type: none"> • Home > Settings > General > Network > Network Status <p>If the TV is not connected to a network, connect it to a network.</p> <p>The upgrade stops if you already have the latest software version.</p>

Precautions and Notes

You can get instructions and information that you must read after installation.

Supported broadcasting audio options

Check the supported broadcasting audio options.

	Audio Type	Dual Sound	Default
A2 Stereo	Mono	Mono	Automatic change
	Stereo	Stereo, Mono	Automatic change
	Dual	Dual I, Dual II	Dual I
NICAM Stereo	Mono	Mono	Automatic change
	Stereo	Mono, Stereo	Automatic change
	Dual	Mono, Dual I, Dual II	Dual I

 If the **Stereo** signal is too weak and an automatic switching occurs, select **Mono**.

 Available only for the stereo signals.

 Available only when the input source is set to **TV**.

Read Before Using Apps

Read this information before using Apps.

- Due to the product characteristics featured on Samsung Smart Hub, as well as limitations in available content, certain features, applications, and services may not be available on all devices or in all territories. Visit <https://www.samsung.com> for more information on specific device information and content availability. Services and content availability are subject to change without prior notice.
- Samsung Electronics takes no legal responsibility whatsoever for any interruption of app services caused by the service provider for any reason.
- Application services may be provided in English only and available content may differ with the geographical area.
- For more information about applications, visit the applicable service provider's website.
- An unstable Internet connection may cause delays or interruptions. In addition, applications may terminate automatically depending on the network environment. If this occurs, check your Internet connection and try again.
- Application services and updates may become unavailable.
- Application content is subject to change by the service provider without prior notice.
- Specific services may differ with the version of the application installed on the TV.
- An application's functionality may change in future versions of the application. If this occurs, run the application's tutorial or visit the service provider's website.
- Depending on the service provider's policies, certain applications may not support multitasking.

Read Before Using the Internet

Read this information before using the Internet.

- The **Internet** is not compatible with Java applications.
- File download is not supported.
- The **Internet** may not be able to access certain websites.
- The TV does not support playback of flash videos.
- E-commerce for online purchases is not supported.
- With websites that have scrollable windows, scrolling a window can result in corrupted characters.
- ActiveX is not supported.
- Only a limited number of fonts are supported. Certain symbols and characters may not be displayed properly.
- The response to remote commands and the resulting on-screen display may be delayed while a web page is loading.
- Loading a web page may be delayed or suspended completely with certain operating systems.
- The copy and paste operations are not supported.
- When composing an email or a simple message, certain functions such as the font size and colour selection may not be available.
- There is a limit to the number of bookmarks and the size of the log file that can be saved.
- The number of windows that can be opened concurrently differs with the search conditions and the TV model.
- The web browsing speed will differ with the network environment.
- If the **Clock** has not been set, the browsing history will not be saved.
 - [Home](#) > [Settings](#) > [General](#) > [System Manager](#) > [Time](#) > [Clock](#)
- The browsing history is saved from latest to oldest, with the oldest entries being overwritten first.
- Depending on the types of video/audio codecs supported, it might not be possible to play certain video and audio files while playing HTML5 Video/Audio.
- Video sources from PC-optimised streaming service providers may not play properly on our proprietary **Internet**.

Read before setting up a wireless Internet connection

Precautions for wireless Internet

- This TV supports the IEEE 802.11 a /b /g /n /ac communication protocols. Samsung recommends using IEEE 802.11n. Video files stored on a device connected to the TV via a Home Network may not play back smoothly.



Some of the IEEE 802.11 communication protocols may not be supported depending on the model.

- To use wireless Internet, the TV must be connected to a wireless router or modem. If the wireless router supports DHCP, the TV can use a DHCP or static IP address to connect to the wireless network.
- Select a channel that is not currently in use for the wireless router. If the channel set for the wireless router is currently being used by another device, the result is usually interference and/or a communications failure.
- Most wireless networks have an optional security system. To enable a wireless network's security system, you need to create a password using characters and numbers. This password is then needed to connect to a security-enabled AP.

Wireless security protocols

The TV only supports the following wireless network security protocols.

- Authentication Modes: WEP, WPAPSK, WPA2PSK
- Encryption Types: WEP, TKIP, AES

The TV cannot connect to non-certified wireless routers.

In compliance with the newest Wi-Fi certification specifications, Samsung TVs do not support WEP or TKIP security encryption in networks running in the 802.11n mode. If the wireless router supports WPS (Wi-Fi Protected Setup), you can connect the TV to your network using PBC (Push Button Configuration) or a PIN (Personal Identification Number). WPS automatically configures the SSID and WPA key settings.

Read Before Playing Photo, Video, or Music Files

Read this information before playing media content.

Limitations on use of photo, video, and music files [Try Now](#)

- The TV supports MSC (Mass Storage Class) USB devices only. MSC is a class designation for mass storage devices. Types of MSC devices include external hard drives, flash card readers, and digital cameras. (USB hubs are not supported.) These kinds of devices must be connected directly to the USB port. The TV may not be able to recognise a USB device or read the files on the device if it is connected with a USB extension cable. Do not disconnect USB devices while they are transferring files.
- When connecting an external hard drive, use the USB (HDD) port. We recommend that you use an external hard drive with its own power adapter.
- Certain digital cameras and audio devices may not be compatible with the TV.
- If there are multiple USB devices connected to the TV, the TV might not be able to recognise some or all the devices. USB devices that use high-power input should be connect to the USB [5V, 1A] port.
- The TV supports the FAT, exFAT, and NTFS file systems.
- After sorting files in the Folder view mode, the TV can display up to 1,000 files per folder. If the USB device contains more than 8,000 files and folders, however, some files and folders might not be accessible.
- Certain files, depending on how they are encoded, may not play on the TV.
- Certain files are not supported on all models.
- DivX and DTS codecs are not supported by the Samsung TV models released in 2018.

Supported external subtitles

Name	Format
MPEG-4 Timed text	.txt
SAMI	.smi
SubRip	.srt
SubViewer	.sub
Micro DVD	.sub or .txt
SubStation Alpha	.ssa
Advanced SubStation Alpha	.ass
SMPTE-TT Text	.xml

Supported internal subtitles

Name	Container
Xsub	AVI
SubStation Alpha	MKV
Advanced SubStation Alpha	MKV
SubRip	MKV
VobSub	MKV
MPEG-4 Timed text	MP4
TTML in smooth streaming	MP4
SMPTE-TT TEXT	MP4
SMPTE-TT PNG	MP4

Supported image formats and resolutions

File extension	Format	Resolution
*.jpg *.jpeg	JPEG	15360 x 9024
*.png	PNG	4096 x 4096
*.bmp	BMP	4096 x 4096
*.mpo	MPO	15360 x 8640

 The MPO format is supported partly.

Supported music formats and codecs

File extension	Format	Codec	Note
*.mp3	MPEG	MPEG1 Audio Layer 3	
*.m4a *.mpa *.aac	MPEG4	AAC	
*.flac	FLAC	FLAC	Supports up to 2 channels
*.ogg	OGG	Vorbis	Supports up to 2 channels
*.wma	WMA	WMA	WMA is supported up to 10 Pro 5.1 channels, M2 profile. WMA1, WMA lossless / Voice are not supported.
*.wav	wav	wav	
*.mid *.midi	midi	midi	Supports type 0 and type 1. Seek is not supported. Supports USB device only.
*.ape	ape	ape	
*.aif *.aiff	AIFF	AIFF	
*.m4a	ALAC	ALAC	

Supported video codecs

File format	Container	Video codecs	Resolution	Frame rate (fps)	Bitrate (Mbps)	Audio codecs
*.avi *.mkv *.asf *.wmv *.mp4 *.mov *.3gp *.vro *.mpg *.mpeg *.ts *.tp *.trp *.mov *.flv *.vob *.svi *.m2ts *.mts	AVI MKV ASF MP4 3GP MOV FLV VRO VOB PS TS SVAF	H.264 BP/MP/HP	1920 x1080	60	20	Dolby Digital LPCM ADPCM(IMA, MS) AAC HE-AAC WMA Dolby Digital Plus MPEG(MP3) G.711(A-Law, μ -Law) OPUS
		HEVC (H.265 - Main, Main10)		30		
		Motion JPEG		60		
		MVC		30		
		MPEG4 SP/ASP		60		
		Window Media Video v9 (VC1)		30		
		MPEG2		60		
		MPEG1		30		
		Microsoft MPEG-4 v1, v2, v3		30		
		Window Media Video v7 (WMV1), v8 (WMV2)		30		
		H.263 Sorrenson		30		
		VP6		30		
		*.webm		WebM		
*.rmvb	RMVB	RV8/9/10 (RV30/40)				RealAudio 6

 The resolution may not be supported depending on the model.

Other restrictions

- Codecs may not function properly if there is a problem with the content.
- Video content does not play or does not play correctly if there is an error in the content or container.
- Sound or video may not work if they have standard bit rates/frame rates above the TV's compatibility ratings.
- If the Index Table is has an error, the Seek (Jump) function will not work.
- When playing video over a network connection, the video may not play smoothly because of data transmission speeds.
- Some USB/digital camera devices may not be compatible with the TV.
- HEVC codec is only available in MKV / MP4 / TS containers.
- The MVC codec is supported partly.

Video decoders

- H.264 is supported up to Level 4.1. (TV does not support FMO / ASO / RS)
- VC1 AP L4 is not supported.
- GMC 2 or above is not supported.

Audio decoders

- WMA is supported up to 10 Pro 5.1 channels, M2 profile.
- WMA1, WMA lossless / Voice are not supported.
- QCELP and AMR NB / WB are not supported.
- Vorbis is supported for up to 5.1 channels.
- Dolby Digital Plus is supported for up to 5.1 channels.
- The supported sample rates are 8, 11.025, 12, 16, 22.05, 24, 32, 44.1, and 48 KHz, and differ with the codec.

Read After Installing the TV

Read this information after installing the TV.

Picture sizes and input signals

The **Picture Size** settings are applied to the current source. The applied **Picture Size Settings** will remain in effect whenever you select that source unless you change them.

Input signal	Picture size
Component	16:9 Standard, Custom, 4:3
Digital channel (720p)	16:9 Standard, Custom, 4:3
Digital channel (1080i, 1080p)	16:9 Standard, Custom, 4:3
HDMI (720p)	16:9 Standard, Custom, 4:3
HDMI (1080i, 1080p)	16:9 Standard, Custom, 4:3
USB (720p)	16:9 Standard, Custom, 4:3
USB (1080i/p @ 60 Hz)	16:9 Standard, Custom, 4:3

Installing an anti-theft lock

An anti-theft lock is a physical device that can be used to protect the TV against theft. Look for the lock slot on the back of the TV. The slot has a  icon next to it. To use the lock, wrap the lock cable around an object that is too heavy to carry and then thread it through the TV's lock slot. The lock is sold separately. The method of using an anti-theft lock may differ for each TV model. Refer to the lock's user manual for more information.

 This function may not be supported depending on the model or geographical area.

Read Before Connecting a Computer (Supported Resolutions)

Check the supported resolution for PC input signals.

Full HD TV

When you connect your TV to a computer, set the computer's video card to one of the standard resolutions listed in the tables below or on the next page. The TV will automatically adjust to the resolution you choose. Note that the optimal and recommended resolution is 1920 x 1080 at 60 Hz. Choosing a resolution not included in the tables can result in a blank screen or just the power indicator turning on. Refer to the user manual of your graphics card for compatible resolutions.

 Optimal resolution depends on your model.

 The resolution may not be supported depending on your model.

IBM

Resolution (Dots x lines)	Display format	Horizontal frequency (KHz)	Vertical frequency (Hz)	Clock frequency (MHz)	Polarity (horizontal / vertical)
720 x 400	70 Hz	31.469	70.087	28.322	- / +

MAC

Resolution (Dots x lines)	Display format	Horizontal frequency (KHz)	Vertical frequency (Hz)	Clock frequency (MHz)	Polarity (horizontal / vertical)
640 x 480	67 Hz	35.000	66.667	30.240	- / -
832 x 624	75 Hz	49.726	74.551	57.284	- / -
1152 x 870	75 Hz	68.681	75.062	100.000	- / -

VESA DMT

Resolution (Dots x lines)	Display format	Horizontal frequency (KHz)	Vertical frequency (Hz)	Clock frequency (MHz)	Polarity (horizontal / vertical)
640 x 480	60 Hz	31.469	59.940	25.175	- / -
640 x 480	72 Hz	37.861	72.809	31.500	- / -
640 x 480	75 Hz	37.500	75.000	31.500	- / -
800 x 600	60 Hz	37.879	60.317	40.000	+ / +
800 x 600	72 Hz	48.077	72.188	50.000	+ / +
800 x 600	75 Hz	46.875	75.000	49.500	+ / +
1024 x 768	60 Hz	48.363	60.004	65.000	- / -
1024 x 768	70 Hz	56.476	70.069	75.000	- / -
1024 x 768	75 Hz	60.023	75.029	78.750	+ / +
1152 x 864	75 Hz	67.500	75.000	108.000	+ / +
1280 x 720	60 Hz	45.000	60.000	74.250	+ / +
1280 x 800	60 Hz	49.702	59.810	83.500	- / +
1280 x 1024	60 Hz	63.981	60.020	108.000	+ / +
1280 x 1024	75 Hz	79.976	75.025	135.000	+ / +
1366 x 768	60 Hz	47.712	59.790	85.500	+ / +
1440 x 900	60 Hz	55.935	59.887	106.500	- / +
1600 x 900	60 Hz	60.000	60.000	108.000	+ / +
1680 x 1050	60 Hz	65.290	59.954	146.250	- / +
1920 x 1080	60 Hz	67.500	60.000	148.500	+ / +

 Optimal resolution depends on your model.

HD TV

After connecting a computer to the TV, set the screen resolution for the TV on the computer. If it is set to any other than in the table below, the TV may display nothing. Set the resolution properly, referring to the user guide of the computer or its graphic card.

 Optimal resolution depends on your model.

 The resolution may not be supported depending on your model.

IBM

Resolution (Dots x lines)	Display format	Horizontal frequency (KHz)	Vertical frequency (Hz)	Clock frequency (MHz)	Polarity (horizontal / vertical)
720 x 400	70 Hz	31.469	70.087	28.322	- / +

MAC

Resolution (Dots x lines)	Display format	Horizontal frequency (KHz)	Vertical frequency (Hz)	Clock frequency (MHz)	Polarity (horizontal / vertical)
640 x 480	67 Hz	35.000	66.667	30.240	- / -
832 x 624	75 Hz	49.726	74.551	57.284	- / -

VESA DMT

Resolution (Dots x lines)	Display format	Horizontal frequency (KHz)	Vertical frequency (Hz)	Clock frequency (MHz)	Polarity (horizontal / vertical)
640 x 480	60 Hz	31.469	59.940	25.175	- / -
640 x 480	72 Hz	37.861	72.809	31.500	- / -
640 x 480	75 Hz	37.500	75.000	31.500	- / -
800 x 600	60 Hz	37.879	60.317	40.000	+ / +
800 x 600	72 Hz	48.077	72.188	50.000	+ / +
800 x 600	75 Hz	46.875	75.000	49.500	+ / +
1024 x 768	60 Hz	48.363	60.004	65.000	- / -
1024 x 768	70 Hz	56.476	70.069	75.000	- / -
1024 x 768	75 Hz	60.023	75.029	78.750	+ / +
1280 x 720	60 Hz	45.000	60.000	74.250	+ / +
1360 x 768	60 Hz	47.712	60.015	85.500	+ / +
1366 x 768	60 Hz	47.712	59.790	85.500	+ / +

 Optimal resolution depends on your model.

Supported Resolutions for Video Signals

Check the supported resolution for video signals.

VESA CVT

Resolution (Dots x lines)	Display format	Horizontal frequency (KHz)	Vertical frequency (Hz)	Clock frequency (MHz)	Polarity (horizontal / vertical)
1920 x 1080	100 Hz	112.500	100.000	297.000	+ / +
1920 x 1080	120 Hz	135.000	120.003	297.000	+ / +

 The resolution may not be supported depending on the model.

CEA-861

Resolution (Dots x lines)	Display format	Horizontal frequency (KHz)	Vertical frequency (Hz)	Clock frequency (MHz)	Polarity (horizontal / vertical)
720 (1440) x 576i	50 Hz	15.625	50.000	27.000	- / -
720 (1440) x 480i	60 Hz	15.734	59.940	27.000	- / -
720 x 576	50 Hz	31.250	50.000	27.000	- / -
720 x 480	60 Hz	31.469	59.940	27.000	- / -
1280 x 720	50 Hz	37.500	50.000	74.250	+ / +
1280 x 720	60 Hz	45.000	60.000	74.250	+ / +
1920 x 1080i	50 Hz	28.125	50.000	74.250	+ / +
1920 x 1080i	60 Hz	33.750	60.000	74.250	+ / +
1920 x 1080	24 Hz	27.000	24.000	74.250	+ / +
1920 x 1080	25 Hz	28.125	25.000	74.250	+ / +
1920 x 1080	30 Hz	33.750	30.000	74.250	+ / +
1920 x 1080	50 Hz	56.250	50.000	148.500	+ / +
1920 x 1080	60 Hz	67.500	60.000	148.500	+ / +

Buttons and functions available while playing multimedia content

Learn about the buttons and features you can use while watching TV or playing media contents.





Press the Select button while playing any video, photo, or recorded content. The following buttons appear.

 The provided buttons and functions may not be supported depending on the model or geographical area.

 The available buttons and functions may differ with the content you are viewing or playing.

- **Pause / Play**

Pauses or plays the multimedia content. You can use the following functions when the video is paused.

- **Slow Rewind** or **Slow Forward**: Allows you to play the video slowly backward or forward by selecting the  or  option. To change the playback speed in 3 levels, press the option repeatedly. To return to normal speed, select the  option or press the  (Play) button.

- **Jump Backward / Jump Forward**

Press the up directional button to move the focus to the playback control bar, and then select the left or right directional button in the playback control bar to move backward or forward by 10 seconds in the video.



- Move to a specific playback section, move up the focus on the playback bar, and then select one of the five thumbnails.

 This function may not be supported depending on the file format.

- **Previous / Next**

Displays the previous or the next multimedia content file.

- **Rewind / Fast Forward**

Rewinds or fast forwards the multimedia content. To increase the rewind or fast forward speed up to 3 times faster than normal, select the button repeatedly. To return to normal speed, select the  option or press the  (Play) button.

- **Repeat**

Plays the current multimedia content repeatedly or all multimedia content files in the same folder repeatedly.

- **Shuffle**



Plays music files in random order.

- **Picture Off**

Plays multimedia content with the screen off.

- **Fit to screen**
Fits a photo to the screen.
- **Zoom**
Zooms in a photo.
- **Rotate left / Rotate right**
Rotates a photo left or right.
- **Background Music**
During a slideshow, pauses or resumes the background music.
- **Options**

 The available options may differ with the model and content.

Function	Description
Slideshow Speed	Sets the slideshow speed.
Slideshow Effect	Applies transition effects to the slide show.
Background Music	Plays background music while the TV displays photos.  The music files must be saved in the same USB device as the photo files.  To pause the background music, select Background Music on the playback screen bottom.
Subtitles	Controls video subtitles. Subtitles: Turns the language of the subtitles on or off. Sync: Adjusts the synchronisation when the video and the subtitles are not synchronised. Reset Sync: Resets the subtitle synchronisation adjustment to 0. Size: Changes the font size of the subtitles. Encoding: Displays a list of encoding languages. Allows you to change the encoding language when subtitles are displayed incorrectly. Edge Type: Adjusts the position of text and subtitle edges. Edge Color: Changes the colour of subtitle edges.
Rotate	Rotates the video.
Audio Language	Changes the audio language you want to hear.  This function is only available if the video supports multi-track sound.
Information	Displays detailed information about the current multimedia content.

Licences & Other Information

Check the licences and other information and trademarks applied in your TV.



Manufactured under license from Dolby Laboratories. Dolby, Dolby Audio, Pro Logic, and the double-D symbol are trademarks of Dolby Laboratories.



The terms HDMI and HDMI High-Definition Multimedia Interface, and the HDMI Logo are trademarks or registered trademarks of HDMI Licensing Administrator, Inc. in the United States and other countries.

Open Source License Notice

Open Source used in this product can be found on the following webpage. (<https://opensource.samsung.com>) Open Source License Notice is written only English.



Trademark: Rovi and Rovi Guide are trademarks of Rovi Corporation and/or its subsidiaries.

License: The Rovi Guide system is manufactured under licence from Rovi Corporation and/or its subsidiaries.

Patent: The Rovi Guide system is protected by patents and patent applications filed in the US, Europe, and other countries including one or more of the United States patents 6,396,546; 5,940,073; 6,239,794 issued to Rovi Corporation and/or its subsidiaries.

Disclaimer: Rovi Corporation and/or its subsidiaries and related affiliates are not in any way liable for the accuracy or availability of the programme schedule information or other data in the Rovi Guide system and cannot guarantee service availability in your area. In no event shall Rovi Corporation and/or its related affiliates be liable for any damages in connection with the accuracy or availability of the programme schedule information or other data in the Rovi Guide system.



(Europe only)

To access energy labelling information about this product on the European Product Registry for Energy Labelling (EPREL), go to https://eprel.ec.europa.eu/qr/*****

where ***** is the product's EPREL registration number. You can find the registration number on the rating label of your product.

(Turkey only)

To access the energy labelling information of the model :

1. Go to https://www.samsung.com/global/ecodesign_energy
2. Get the model identifier from the energy label of the product and type it in the search box
3. Energy labelling information can be found

Accessibility Guidance

Provides a menu and a remote control guide that aid the visually impaired.

Menu Learning Screen

Learn the menus on the TV screen. Once enabled, your TV will tell you the structure and features of the menus you select.

Using the accessibility menu

[View descriptions of accessibility menu functions.](#)

 This function may not be supported depending on the model or geographical area.

Accessibility Shortcuts menu

Press the AD/SUBT. button to display the [Accessibility Shortcuts](#) menu.

The [Accessibility Shortcuts](#) menu allows you to turn [Voice Guide](#) on or off by changing the settings. [Voice Guide](#) speaks the menu items displayed on the screen so that people who cannot see the screen can easily use the TV.

The menu contains a number of items including:

- **Voice Guide:** This function works on every screen on the TV and when turned on speaks to identify items displayed on screen. For example, it tells you the selected volume, the current channel and programme information. It also reads out the programme information in the Electronic Programme Guide (EPG).
- **High Contrast:** This function allows you to display all menus with an opaque black background and a white font, providing maximum contrast.
- **Enlarge:** This function enlarges important elements on the screen such as the names of programmes.
- **Learn TV Remote:** Learn the names and functions of the buttons on remote control. On this screen, pressing the power button (top left button) will turn off the TV, but when any other button is pressed the TV will say the button name and briefly tell what that button does. This teaching mode helps you to learn the location and operation of the buttons on the remote without affecting normal TV operation. Press the  or EXIT button twice to exit [Learn TV Remote](#).
- **Menu Learning Screen:** Learn the menus on the TV screen. Once enabled, your TV will tell you the structure and features of the menus you select.

Opening the Accessibility Shortcuts menu

If you press the AD/SUBT. button while Voice Guide is turned off, the [Accessibility Shortcuts](#) menu appears and Voice Guide starts. You can turn on or turn off the functions such as [Voice Guide](#), [Audio Description](#), [High Contrast](#), [Enlarge](#), [Learn TV Remote](#), [Menu Learning Screen](#), [Subtitle](#), and you can move to the [Learn TV Remote](#) and [Menu Learning Screen](#) pages.

 [Learn TV Remote](#) and [Menu Learning Screen](#) are only available when [Voice Guide](#) is enable.

Using the Accessibility Shortcuts menu

To use the [Accessibility Shortcuts](#) menu, you will need to locate the Directional and Select buttons. To learn where the buttons are located, refer to [Learn TV Remote](#) menu.

Use the up and down directional buttons to move between the menu items. Press the Select button to turn on or turn off the function indicated by the menu where you are located. Again, use the up and down directional to move between options and press Select to choose an option. To close this menu, use the right directional button to get to the [Close](#) option and select this, or press the  button.

Step by Step instructions to run the options

Turning on Voice Guide

1. Press the AD/SUBT. button on the remote. The [Accessibility Shortcuts](#) menu appears.
2. Press the up or down directional buttons on the remote to move to and highlight the [Voice Guide](#) option.
3. Press the Select button on the remote to turn [Voice Guide](#) on or off.
4. Close the menu either by pressing  on the remote or by pressing the right directional button to highlight [Close](#), and then pressing the Select button.

Turning on Audio Description

1. Press the AD/SUBT. button on the remote. The [Accessibility Shortcuts](#) menu appears.
2. Press the up or down directional buttons on the remote to move to and highlight the [Audio Description](#) option.
3. Press the Select button on the remote to turn [Audio Description](#) on or off.
4. Close the menu either by pressing  on the remote or by pressing the right directional button to highlight [Close](#), and then pressing the Select button.

 This function is only available when it is supported by the programme that is currently broadcasting.

Learning TV Remote



1. Press the AD/SUBT. button on the remote. The [Accessibility Shortcuts](#) menu appears.
2. Press the up or down directional buttons on the remote to move to and highlight the [Learn TV Remote](#) option.
3. Press the Select button on the remote. You are now in the e-Manual and specifically on the [Learn TV Remote](#) page.
4. Press a button on the remote. The name and function of the button are heard.
5. When you have finished and want to exit [Learn TV Remote](#), press the  or EXIT button twice.

 This function is only available when [Voice Guide](#) is enabled.

Accessing the main accessibility menu to change Voice Guide settings

You can also go to an accessibility menu from the TV settings menu. This provides more options, for example, to change the speed of Voice Guide.

The TV will not verbalise this menu unless Voice Guide is already turned on.

1. Press the  button.
2. Press the left directional button until you reach  [Settings](#).
3. Press Select and a menu will open.
4. Press the down directional button to reach [General](#), and then press Select to open this menu.
5. Use the directional buttons to go to the [Accessibility](#) menu, and then press Select to open this menu.
6. The menu will appear with [Voice Guide Settings](#) being the first menu. Highlight [Voice Guide Settings](#), and then press Select.
7. A menu appears with the options to change [Voice Guide](#) and [Volume, Speed, Pitch](#).
8. Select the menu using the directional buttons, and then press Select.

Using the TV with Voice Guide on

You can turn on Voice Guide that describe the menu options aloud to aid the visually impaired.

Watching TV

Turning the TV on

Press the  button to turn the TV on.

 When the TV turns on in the TV mode, voice guide will speak the channel name.

Changing channel

You can change the channel in a number of ways. Every time you change channels, the new channel details will be announced. The ways to change the channel are below.

- **Channel List** ( > **Live TV** > **Channel List**)

Press the  button. The Home Screen appears. Use the left or right directional buttons to move to **Live TV**, press the up directional button to move to the top row, press the right directional button to move to **Channel List**, and then press the Select button. In the **Channel List**, use the up or down directional buttons to move to the desired channel, and then press the Select button.

- Use the number buttons directly or press the CH button on the standard remote control to change the channel.

Changing volume

Use the VOL button on the left to change the volume. Every time you change the volume, the new volume level will be announced.

Using programme information

When watching TV, press the Select button to view programme information which appears at the top of the screen. Voice Guide will say programme subtitles or audio descriptions if they are available. To view more detailed programme information, press and hold the Select button. Voice Guide will say more details such as a synopsis of the programme.

Press the left or right directional button to see what you can watch next on the same channel. Press the up or down directional button to move to other channels and to see which programmes are currently being broadcast on them.

Press  to go back or close the programme details.

 This function may not be supported depending on the model or geographical area.





Using the guide

See an overview of each channel's programme lineup.



When you want to know the programme information for each channel while watching a broadcast programme, press the GUIDE button on the remote control. Use the directional buttons to view the programme information.

 > [Live TV](#) > [Guide](#)

You can see the daily programme schedules for each broadcaster and programme information in the [Guide](#). You can select programmes to schedule for viewing.

-  This function may not be supported depending on the model or geographical area.
-  The information in the [Guide](#) is for digital channels only. Analogue channels are not supported.
-  If the [Clock](#) is not set, the Guide is not provided. Set the [Clock](#) first. ( >  [Settings](#) > [General](#) > [System Manager](#) > [Time](#) > [Clock](#))

If you need to set the clock again, follow the instructions below.

1. Press the  button to open [Smart Hub](#).
2. Press the left directional button to move to  [Settings](#).
3. Press the Select button to display the [Settings](#) menu screen.
4. Use the up and down directional buttons to move to the [General](#) menu, and then press the Select button.
5. Use the up and down directional buttons to move to the [System Manager](#) menu, and then press the Select button.
6. Select the [Time](#) menu, and then press the Select button.
7. Select the [Clock](#) menu, and then press the Select button.
8. Select the [Clock Mode](#) menu, press the Select button, and then select [Auto](#) or [Manual](#).

 If you select [Manual](#), you can move to the [Date](#) or [Time](#) menu below to set the time.

When you open the [Guide](#), a table grid of channels and programmes is displayed. The top row displays [Filter By : All](#) then the day and times. Each row has a channel name on the left and programmes on that channel on the right.

In the [Guide](#), use the up and down directional buttons to move between channels and use the left and right directional buttons move to between programmes within a channel. You can use the  (Play) button to go to the current time.

When you move the focus to a programme, you will hear the detailed information about the selected programme. You will also hear if the [Audio Description](#) and [Subtitles](#) are available for the programme. When you move the focus to a different channel, you will hear the channel name and number, and the programme details. If you move to a different day, you will hear the day announced for the first programme you reach on that day. The day is not repeated, so if you are not sure what the day is, you can move forwards and backwards 24 hours and then the day will be announced.

To view a programme on now

In the [Guide](#), move to the programme currently broadcasting, and then press the Select button to go to live TV on the selected channel and programme.

Other options in the guide

In the [Guide](#), move to a broadcast scheduled programme, and then press the Select button. A pop-up menu listing the functions below appears. For the programme you are currently watching, press and hold the Select button.

Use the up and down directional buttons to move within this menu, and then press Select to choose an item. Press  to close the menu and go back to the [Guide](#).

- [Schedule Viewing](#)

You can schedule viewing for a broadcast scheduled programme.

- [Cancel Scheduled Viewing](#)

You can cancel your scheduled viewings.



This function may not be supported depending on the model or geographical area.

- [View Details](#)

You can see the detailed information on the selected programme. The information may differ with the broadcast signal. If the information is not provided with the programme, nothing appears.

Press Select on the [View Details](#) option. This will open the Details pop-up window for that programme which will display a synopsis. The details pop-up window consists of detailed information and the [OK](#) option. After reading the detailed information, press the Select button on the remote control to close the pop-up window.

Displaying your favourite channels:

If you have set up favourite channels, you will be able to filter the **Guide** so that only those channels are shown. This makes it easier to find channels you want.



To display your favourites list, move to the current time (press the  (Play) button) and then press the left directional button to move to the list of channels. Use the up directional button to move up the list until you reach the **Filter By : All** option. Press Select to bring up a list of options. Use the up and down directional buttons to move between the categories in the list. Highlight the option you want, for example, **Favourites 1**, and then press Select. The **Guide** will then show the information for only those channels.

 When you have set a filter in the **Guide**, it will remain when you close and re-open the **Guide**. If you find that you don't have the channels you think you should, it is a good idea to check the category, and then select "**Filter By : All**" which will display all tuned channels.

Setting Up a Schedule Viewing

Configure the TV to show a specific channel or programme at a specific time and date.

The  icon appears next to programmes that have been configured for a schedule viewing.

 To set up a schedule viewing, you must first set the TV's clock ( >  **Settings** > **General** > **System Manager** > **Time** > **Clock**).

Setting up a schedule viewing

- **The Guide Screen**

On the **Guide** screen, select a programme you would like to view, and then press and hold the Select button. Select **Schedule Viewing** on the pop-up menu that appears.

- **The Programme Info Screen**

Press the Select button while watching the TV. The Programme Info window appears. Select a broadcast scheduled programme by using the left or right directional buttons, and then the Select button. You can schedule watching the programme by selecting **Schedule Viewing**.

Cancelling a scheduled viewing

You have two ways to cancel a scheduled viewing.

1. Cancelling a scheduled viewing from the Guide

 > [Live TV](#) > [Guide](#)

Move to the programme for which you want to cancel scheduled viewing, and press the Select button. Move to [Cancel Scheduled Viewing](#), and then press the Select button. When a pop-up message asking you to cancel the selected schedule viewing appears, select [Yes](#). The selected scheduled viewing is cancelled and the screen returns to the [Guide](#) screen.

2. Cancelling a scheduled viewing from Smart Hub

 > [Live TV](#) > [Schedule Manager](#) > [Scheduled Manually](#) > [Delete](#)

1. Press  the button to open [Smart Hub](#), and then press the left or right directional button to move to [Live TV](#). Press the up directional button to move to the top row, and then press the left or right directional button to move to [Schedule Manager](#).
2. Press Select to open [Schedule Manager](#).
3. Use the down directional button to move to the list of programmes scheduled to view.
4. Use the right directional button to move to the [Delete](#) option, and then press the Select button to delete the selected item.

 The menus may not appear depending on the model or geographical area.

Using the Channel List

See how to list the channels available on your TV.

> [Live TV](#) > [Channel List](#)

Using [Channel List](#), you can change the channel or check programmes on other digital channels while watching TV.

Press the  button. The Home Screen appears. Use the left or right directional buttons to move to [Live TV](#), press the up directional button to move to the top row, press the right directional button to move to [Channel List](#), and then press the Select button. This shows a list of the channels and the programme currently on. The focus will be on the channel you are currently watching, showing channel name, channel number, and programme title.

Use the up and down directional buttons to move within the channel list.

Press the right directional button in the Channel List to move to the Category list. Use the up and down directional buttons to move within this list. Press the Select button to choose a category you want from the Category list. The Category list contains [All Channels](#) and [Favourites](#). Use the up and down directional buttons to move to a channel you want to view, and then press the Select button.

- [All](#)

Displays the channels that have been automatically searched.

- [TV PLUS](#)

While the TV is connected to the Internet, you can watch popular programmes or highlights for each theme through a virtual channel at any time. As in a general channel, it provides the daily programme schedules of [TV PLUS](#).



This function may not be supported depending on the model or geographical area.

- [Favourites](#)

Displays [Favourites 1](#) to [Favourites 5](#). Use the up and down directional buttons to move between the lists of favourites. Highlight the one you want, and then press Select. The channel list will now show only the channels in this list.

- [Channel Type](#)

Sorts the list so that it includes channels of a selected type. However, [Channel Type](#) can only be used channels contain the type information.



This function may not be supported depending on the incoming broadcast signal.

- **Sort**

Sorts the list by **Number** or by **Name**.

 This option is only available on digital channels and may not always be available.

- **Terrestrial, Cable, or Satellite**

Allows you to choose between **Terrestrial**, **Cable**, and **Satellite**.

 This function may not be supported depending on the incoming broadcast signal.

 This function may not be supported depending on the model or geographical area.

Creating a Personal Favourites List

Designate frequently watched channels as favourite channels.

Favourite channels are highlighted in the **Edit Channel** and **Channel List** screens with the symbol .

Registering channels as favourites

 > **Live TV** > **Channel List**

1. Press the right directional button to move to the Category list.
2. Select **Favourites**.
3. When you select a favourites list, the **Edit Favourites** screen appears.
4. Move to the channel you want to add, and then press the Select button.
5. Repeat Step 4 to select all the channels you want to add.
6. Press the right directional button to move to the  icon, and then press the Select button. The selected channels are added to the favourites list.

To add channels to a favourites list - Detail

1. Open the [Channel List](#).
2. Press the right directional button to move to the Category list.
3. Use the up and down directional buttons to move to [Favourites](#), and then press Select. You will see [Favourites 1](#) to [Favourites 5](#). Move to the list to which you want to add channels, and then press the Select button.
4. Use the up directional button to move to [Edit Favourites](#), and then press the Select button.
5. In the [Edit Favourites](#) screen, move to a channel you want to add to the favourites list, and then press the Select button.
6. Repeat Step 5 to select all channels you want to add.
7. Press the right directional button to move to the  icon, and then press the Select button. The selected channels are added to the favourites list.

Deleting channels from a favourites list – Detail

1. Open the [Channel List](#).
2. Press the right directional button to move to the Category list.
3. Use the up and down directional buttons to move to [Favourites](#), and then press Select. You will see [Favourites 1](#) to [Favourites 5](#). Move to the list from which you want to delete channels, and then press the Select button.
4. Use the up directional button to move to [Edit Favourites](#), and then press the Select button.
5. In the [Edit Favourites](#) screen, move to a channel you want to delete from the favourites list, and then press the Select button.
6. Repeat Step 5 to select all channels you want to delete.
7. Press the left directional button to move to the  icon, and then press the Select button. The selected channels are deleted from the favourites list.

Viewing and selecting channels on favourites lists only

[Home](#) > [Live TV](#) > [Channel List](#)







1. Open the [Channel List](#).
2. Press the right directional button to move to the Category list.
3. Use the up and down directional buttons to move to [Favourites](#), and press the Select button.
4. The [Favourites 1](#) to [Favourites 5](#) appear. Move to the list you want, and then press the Select button. The channels in the selected favourites list appear.

Using Smart Hub

Learn how to open Smart Hub to access apps, games, movies, and more.

Smart Hub

After pressing the [Home](#) button on your remote control, you can surf the web and download apps with Smart Hub.

-  Some [Smart Hub](#) services are for pay services.
-  To use [Smart Hub](#), the TV must be connected to the Internet.
-  Some [Smart Hub](#) features may not be supported depending on the service provider, language, or geographical area.
-  [Smart Hub](#) service outages can be caused by disruptions in your Internet service.
-  To use Smart Hub, you must agree to the Smart Hub service agreement, and collection and use of personal information. Without giving consent, you cannot use the additional features and services. You can view the entire text of the [Terms & Privacy](#) by navigating to [Home](#) > [Settings](#) > [Terms & Privacy](#).
-  If you want to stop using [Smart Hub](#), you can cancel the agreement. To cancel the Smart Hub service agreement though it is a required one, select [Reset Smart Hub](#) ([Home](#) > [Settings](#) > [Support](#) > [Self Diagnosis](#) > [Reset Smart Hub](#)).

Press the [Home](#) button on your remote. This will bring up a display with 2 rows. Try moving the focus to [Live TV](#) or another item on the bottom row. The options on the top row change depending on the item selected in the bottom row.

The buttons to the right of **Live TV** provide quick access to apps such as **Netflix** and **Amazon**. Currently, many of these apps are not accessible with Voice Guide.

Use the left and right directional buttons to move between a menu or apps on a row and the up and down directional buttons to move between rows. Press Select to access a menu or apps.

When you open **Smart Hub**, move the focus to **Live TV** or **TV PLUS**. Press the up directional button to move to the top row. You will be on the **Guide** item. The items in this row are:

- **Guide**: Select to go to the screen where you can view the programme guide to multiple channels.
- **Channel List**: Select to open the channel list to view and move to programmes that are being broadcast on other channels.
- **Schedule Manager**: You can go to the **Schedule Manager** screen.



The menus may not appear depending on the model or geographical area.

- To the right of **Schedule Manager**, you can see the programmes you viewed most recently and the programmes that are currently broadcasting on other channels. To go to one of those channels, move to it, and then press the Select button.



The menus may not appear depending on the model or geographical area.



Using the Home Screen in Smart Hub

At the leftmost part of the Home Screen in Smart Hub is the static menu listed below. You can quickly and easily use the listed menu items to access the main TV settings or external devices, search, and apps.

-  **Notification**

You can view a list of notifications for all events that occur on your TV. A notification appears on the screen when it is time to broadcast a scheduled programme or when an event occurs on a registered device.

If you move the focus to **Notification**, and then press the Select button, a notification window appears on the right and the following functions are available:

-  **Delete All**: You can delete all your notifications.
-  **Settings**: You can select services you want to be notified about. When you select **Allow sound**, notifications are displayed with a notification sound.

-  **Settings**

When the focus is moved to the  icon, a list of quick settings icons appears above the top of the menu. You can quickly set frequently used functions by clicking the icons.

- **Picture Mode**

You can select the picture mode that provides the best viewing experience. To change the picture mode, press the Select button. To make fine adjustments, press the up directional button, and then select **Picture Setup**.

- **Sound Mode**

You can select a sound mode to optimise your listening experience. To change the sound mode, press the Select button. To make fine adjustments, press the up directional button, and then select **Equaliser Setup**.

- **Sound Output**

You can select which speakers the TV uses for audio output. To change the audio output, press the Select button.

- **Audio Language**

You can change the audio language you want to hear. To make fine adjustments, press the up directional button, and then select **Go to Audio Options**.

- **Subtitle**

You can watch TV broadcasts with subtitles. To activate/deactivate the **Subtitle** function, press the Select button. To run **Accessibility Shortcuts**, press the up directional button, and then select **Accessibility Shortcuts**.

- **Sleep Timer**

You can automatically shut off the TV after a pre-set period of time.

To set the sleep time to up to 180 minutes, press the Select button. To make detail off timer, press the up directional button, and then select **Set Up Off Timer**.



This function may not be supported depending on the model or geographical area.

- **Network**

You can view the current network and Internet status. Press the up directional button, and then select **Network Status** or **Network Settings**.



This function may not be supported depending on the model or geographical area.

-  **Source**

You can select an external device connected to the TV.

 For more information, refer to "[Switching between external devices connected to the TV](#)".

-  **Search**

A Virtual keyboard appears on the screen, and you can search for channels, titles of movies, or apps provided by the Smart Hub service.

 To use this feature, the TV must be connected to the Internet.

-  **APPS**

You can enjoy a wide range of content including news, sports, weather, and games by installing the corresponding apps on your TV.

 To use this feature, the TV must be connected to the Internet.

 For more information, refer to "[Using the Apps Service](#)".

-  **Universal Guide**

Universal Guide is an app that allows you to search for and enjoy various content such as TV shows, dramas, and movies in one place. **Universal Guide** can recommend content tailored to your preferences and notify you of new drama series.



 For more information about the **Universal Guide**, refer to "[Using the Universal Guide App](#)".

 Images may look blurry depending on the service provider's circumstances.

 This function may not be supported depending on the model or geographical area.

Launching the e-Manual

Open the user manual embedded in your TV.

Press the E-MANUAL button on the standard remote control to open the menu. Alternatively, press the  button to open **Smart Hub**, press the left directional button to move to  **Settings**, and then press the Select button.

Use the up and down directional buttons to move to **Support**, and then select **Open e-Manual** to open the e-Manual.



 >  **Settings** > **Support** > **Open e-Manual**

You can view the embedded e-Manual containing information about your TV's key features.

 Alternatively, you can download a copy of the e-Manual from Samsung's website.

 Words in blue (e.g., **Picture Mode**) indicate a menu item.

The e-Manual contains 2 rows of menu icons. Use the up and down directional buttons to move between rows and the left and right directional buttons to move within a row. Press Select to open the section you want to read.

The e-Manual contains a section called "Learn TV Remote" in the **Accessibility Guidance** (at the right corner of the screen). This is particularly useful for people who cannot easily see the buttons on the control or who are not clear what each button does. When you are viewing this section of the e-Manual, pressing the buttons on the remote control will not affect the TV. Note that the "Accessibility Guidance" item is only available when **Voice Guide** ( >  **Settings** > **General** > **Accessibility** > **Voice Guide Settings** > **Voice Guide**) is enabled.