

SAMSUNG

INSTALL GUIDE

UHD TV

HG43ET690U HG50ET690U HG55ET690U
HG65ET690U HG75ET690U

Thank you for purchasing this Samsung product.

To receive more complete service, please register your product at www.samsung.com

Model _____ Serial No. _____

Before Reading This Install Guide

This TV model is designed for hotels or the other hospitality businesses, supports a variety of special functions, and lets you limit some user (guest) controls.

Figures and illustrations in this Install Guide are provided for reference only and may differ from the actual product appearance. Product design and specifications may change without notice.

Operational Modes

This TV has two modes: **Interactive** and **Standalone** mode.

- **Interactive** mode: In this mode, the TV communicates with and is fully or partially controlled by a connected Set Back Box (SBB) or Set Top Box (STB) provided by a hospitality System Integration (SI) vendor. When the TV is initially plugged in, it sends a command that attempts to identify the SSB or STB connected to it. If the TV identifies the SBB or STB and the SBB or STB identifies the TV, the TV gives full control to the SBB or STB.
- **Standalone** mode: In this mode, the TV works alone without an external SBB or the STB.

The TV has a **Hotel Option** menu that lets you easily set its various hospitality functions. Please see page 31.

The menu also lets you activate or de-activate some TV and hospitality functions so you can create your optimal hospitality configuration.

Still image warning







Avoid displaying still images (such as jpeg picture files) or still image elements (such as TV channel logos, panorama or 4:3 format images, stock or news bars or crawls) on the screen. Displaying still pictures continually can cause uneven screen wear, which will affect image quality. To reduce the chance that this effect will occur, please follow the recommendations below:

- Avoid displaying the same TV channel for long periods.
- Always try to display a full screen image.
- Reduce brightness and contrast to help prevent the occurrence of after-images.
- Use all TV features designed to reduce image retention and screen burn-in.

Warning! Important Safety Instructions

Please read the Safety Instructions before using your TV.

Refer to the table below for an explanation of symbols which may be on your Samsung product.

CAUTION			Class II product: This symbol indicates that a safety connection to electrical earth (ground) is not required. If this symbol is not present on a product with a mains lead, the product MUST have a reliable connection to protective earth (ground).
RISK OF ELECTRIC SHOCK. DO NOT OPEN.			
CAUTION: TO REDUCE THE RISK OF ELECTRIC SHOCK, DO NOT REMOVE COVER (OR BACK). THERE ARE NO USER SERVICEABLE PARTS INSIDE. REFER ALL SERVICING TO QUALIFIED PERSONNEL.			AC voltage: Rated voltage marked with this symbol is AC voltage.
	This symbol indicates that high voltage is present inside. It is dangerous to make any kind of contact with any internal part of this product.		DC voltage: Rated voltage marked with this symbol is DC voltage.
	This symbol indicates that this product has included important literature concerning operation and maintenance.		Caution. Consult instructions for use: This symbol instructs the user to consult the user manual for further safety related information.

- The slots and openings in the cabinet and in the back or bottom are provided for necessary ventilation. To ensure reliable operation of this apparatus and to protect it from overheating, these slots and openings must never be blocked or covered.
 - Do not place this apparatus in a confined space, such as a bookcase or built-in cabinet, unless proper ventilation is provided.
 - Do not place this apparatus near or over a radiator or heat register, or where it is exposed to direct sunlight.
 - Do not place vessels (vases etc.) containing water on this apparatus, as this can result in a fire or electric shock.
- Do not expose this apparatus to rain or place it near water (near a bathtub, washbowl, kitchen sink, or laundry tub, in a wet basement, or near a swimming pool, etc.). If this apparatus accidentally gets wet, unplug it and contact an authorised dealer immediately.
- This apparatus uses batteries. In your community, there might be environmental regulations that require you to dispose of these batteries properly. Please contact your local authorities for disposal or recycling information.
- Do not overload wall outlets, extension cords, or adaptors beyond their capacity, since this can result in fire or electric shock.
- Power-supply cords should be placed so that they are not likely to be walked on or pinched by items placed upon or against them. Pay particular attention to cords at the plug end, at wall outlets, and at the point where they exit from the appliance.
- To protect this apparatus from a lightning storm, or when left unattended and unused for long periods of time, unplug it from the wall outlet and disconnect the antenna or cable system. This will prevent damage to the set due to lightning and power line surges.

- Before connecting the AC power cord to the DC adaptor outlet, make sure that the voltage designation of the DC adaptor corresponds to the local electrical supply.
- Never insert anything metallic into the open parts of this apparatus. This may cause a danger of electric shock.
- To avoid electric shock, never touch the inside of this apparatus. Only a qualified technician should open this apparatus.
- Be sure to plug in the power cord until it is firmly seated. When unplugging the power cord from a wall outlet, always pull on the power cord's plug. Never unplug it by pulling on the power cord. Do not touch the power cord with wet hands.
- If this apparatus does not operate normally - in particular, if there are any unusual sounds or smells coming from it - unplug it immediately and contact an authorised dealer or service centre.
- Be sure to pull the power plug out of the outlet if the TV is to remain unused or if you are to leave the house for an extended period of time (especially when children, elderly, or disabled people will be left alone in the house).
 - Accumulated dust can cause an electric shock, an electric leakage, or a fire by causing the power cord to generate sparks and heat or by causing the insulation to deteriorate.
- Be sure to contact an authorised Samsung service centre for information if you intend to install your TV in a location with heavy dust, high or low temperatures, high humidity, chemical substances, or where it will operate 24 hours a day such as in an airport, a train station, etc. Failure to do so may lead to serious damage to your TV.
- Use only a properly grounded plug and wall outlet.
 - An improper ground may cause electric shock or equipment damage. (Class I Equipment only.)
- To turn off this apparatus completely, disconnect it from the wall outlet. To ensure you can unplug this apparatus quickly if necessary, make sure that the wall outlet and power plug are readily accessible.
- Store the accessories (batteries, etc.) in a location safely out of the reach of children.
- Do not drop or strike the product. If the product is damaged, disconnect the power cord and contact a Samsung service centre.
- To clean this apparatus, unplug the power cord from the wall outlet and wipe the product with a soft, dry cloth. Do not use any chemicals such as wax, benzene, alcohol, thinners, insecticide, aerial fresheners, lubricants, or detergents. These chemicals can damage the appearance of the TV or erase the printing on the product.
- Do not expose this apparatus to dripping or splashing.
- Do not dispose of batteries in a fire.
- Do not short-circuit, disassemble, or overheat the batteries.
- **CAUTION:** There is danger of an explosion if you replace the batteries used in the remote with the wrong type of battery. Replace only with the same or equivalent type.
- **WARNING - TO PREVENT THE SPREAD OF FIRE, KEEP CANDLES AND OTHER ITEMS WITH OPEN FLAMES AWAY FROM THIS PRODUCT AT ALL TIMES.**
- Use care when touching the TV after it has been on for some time. Some parts can be warm to the touch.



Contents

	Before Reading This Install Guide	2
	Warning! Important Safety Instructions	3
01	What's in the Box?	
02	TV Installation	
	Assembling the swivel (43"-55")	9
	Installing the LED TV Stand	10
	Installing the wall mount kit	13
	Securing the TV to the Wall	14
	Wall Mount Kit Specifications (VESA)	15
	Providing proper ventilation for your TV	16
03	The Remote Control	
	About the Buttons on the Remote Control	17
	Installing batteries into the remote control (Battery size: AAA)	18
04	Initial Setup	
	Using the TV Controller	20
05	The Connection Panel	
06	Connections	
	Connecting to your Internet network	23
	Connecting the TV to an SBB or STB	25
	Connecting the Bathroom Speakers	26
	Connecting the RJP (Remote Jack Pack)	27
07	Using a TV Viewing Card ("CI or CI+ Card")	
	Connecting the "CI or CI+ Card" via COMMON INTERFACE slot with the CI CARD Adapter	29
	Connecting the "CI or CI+ Card" via COMMON INTERFACE slot	30
	Using the "CI or CI+ Card"	30

08	Setting the Hotel Option Menus	
	Hotel Option menu items	32
	Welcome Message	43
	Hotel Logo	43
	USB Cloning	44
	Settings Cloned in the Hotel Menu	46
	Setting Auto Initialise	49
	Updating the TV's Software	53
09	Using a Multi Code Remocon	
10	Setting the Soundbar	
	Samsung Soundbar and Hospitality TV	55
11	Editing Channels	
	Channel Bank Editor (Smooovie TV Only)	56
	Using Channel Editor	57
12	Anti-theft Kensington Lock	
13	Specifications and Other Information	
	Specifications	61
	Environmental Considerations	62
	Decreasing power consumption	62
	Supported Resolutions for UHD Input Signals	63
	Display Resolution	63
	Dimensions	65
	Licences	69

01 What's in the Box?

Make sure the following items are included with your TV. If any items are missing, contact your dealer.

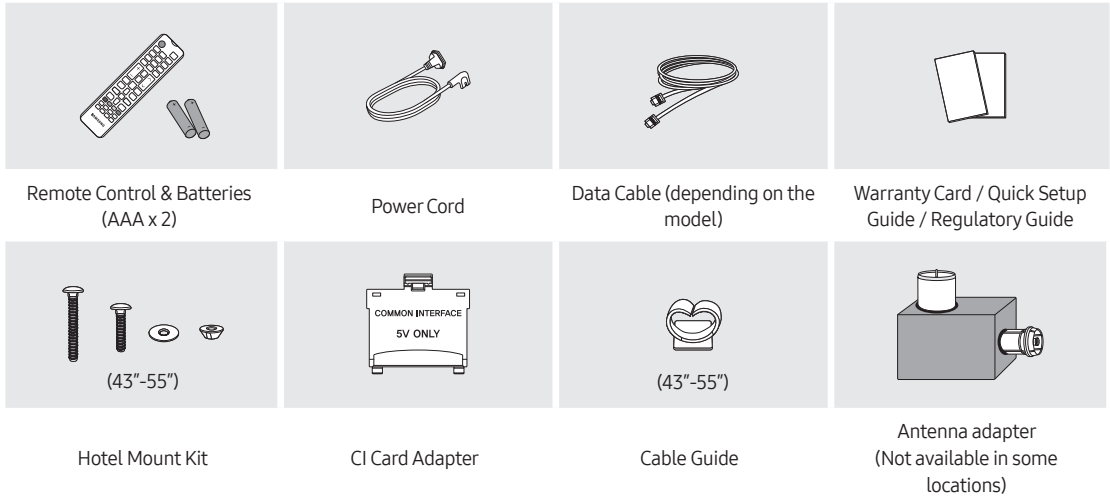

- The items' colours and shapes may vary depending on the models.
- Cables not included can be purchased separately.
- Check for any accessories hidden behind or in the packing materials when opening the box.

An administration fee may be charged in the following situations:

(a) An engineer is called out at your request, but it is found that the product has no defect (i.e., where the user manual has not been read).

(b) You bring the unit to a repair centre, but it is found that the product has no defect (i.e., where the user manual has not been read).

You will be informed of the administration fee amount before a technician visits.



The screen can be damaged from direct pressure when handled incorrectly. As shown in the figure, make sure to grip the edges of the screen when you lift the TV.

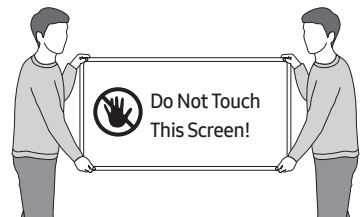



**Correct Disposal of This Product (Waste Electrical & Electronic Equipment)
(Applicable in countries with separate collection systems)**

This marking on the product, accessories or literature indicates that the product and its electronic accessories (e.g. charger, headset, USB cable) should not be disposed of with other household waste at the end of their working life. To prevent possible harm to the environment or human health from uncontrolled waste disposal, please separate these items from other types of waste and recycle them responsibly to promote the sustainable reuse of material resources.

Household users should contact either the retailer where they purchased this product, or their local government office, for details of where and how they can take these items for environmentally safe recycling.

Business users should contact their supplier and check the terms and conditions of the purchase contract. This product and its electronic accessories should not be mixed with other commercial wastes for disposal.



**Correct disposal of the batteries in this product
(Applicable in countries with separate collection systems)**

This marking on battery, manual or packaging indicates that the batteries in this product should not be disposed of with other household waste at the end of their working life. Where marked, the chemical symbols Hg, Cd or Pb indicate that the battery contains mercury, cadmium or lead above the reference levels in EC Directive 2006/66. If batteries are not properly disposed of, these substances can cause harm to human health or the environment.

To protect natural resources and to promote material reuse, please separate batteries from other types of waste and recycle them through your local, free battery return system.

For information on Samsung's environmental commitments and product-specific regulatory obligations, e.g. REACH, WEEE, Batteries, visit http://www.samsung.com/uk/aboutsamsung/samsungelectronics/corporatecitizenship/data_corner.html

02 TV Installation

Assembling the swivel (43"-55")



WARNING: If you configure the TV to swivel, you must attach it securely to the floor, a desk, a dresser top, etc. as described in the installation instructions.

The LED TVs have swivel stands. You can configure these stands so that the TVs swivel 20 degrees left and right, 60 degrees left and right, or 90 degrees left and right using the BRACKET HOLDER SWIVEL.

- This function is not available on the HG65ET690U, HG75ET690U model.

* The product ships with its stand's swivel angle set to 20°.

* 20° swivel

To configure the TV so that it swivels 20° left and right, insert the prong on the bottom of the stand through the curved hole in the Bracket Holder Swivel marked 20°. Then, fix the Bracket Holder Swivel to the stand using the three supplied screws as shown below.

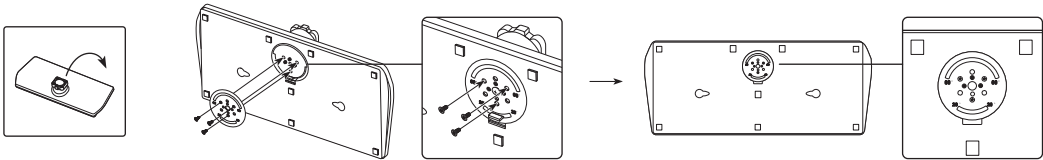

60° swivel

To configure the TV so that it swivels 60° left and right, insert the prong on the bottom of the stand through the curved hole in the Bracket Holder Swivel marked 60°. Then, fix the Bracket Holder Swivel to the stand using the three supplied screws as shown below.

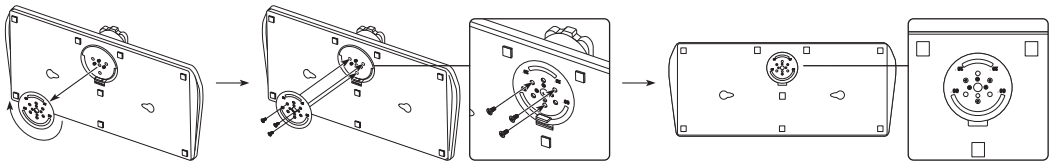

90° swivel

To configure the TV so that it swivels 90° left and right, remove the Bracket Holder Swivel, and then screw the three supplied screws into the stand as shown below.

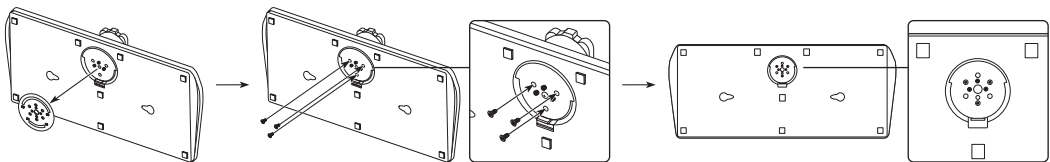

Installing the LED TV Stand

Assembling the Stand and Components (43"-55")

When installing the stand, use the provided components and parts.

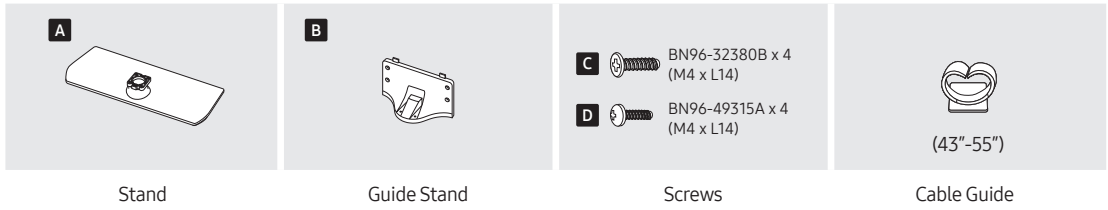

1

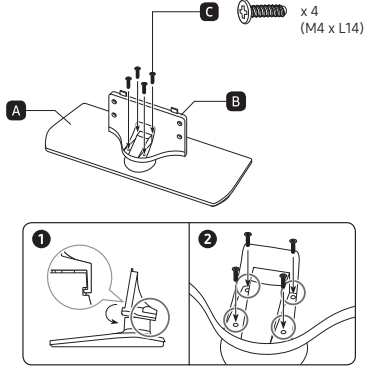

2

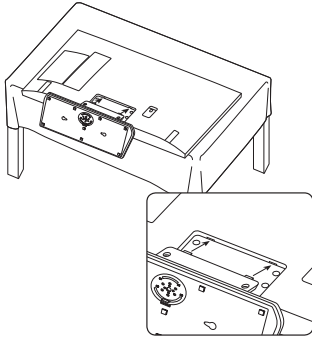

- Place a soft cloth over the table to protect the TV, and then place the TV so that its screen faces down toward the table surface.
- Insert the Stand Guide into the slot on the bottom of the TV.
- Slide and assemble it to the end line in the direction of arrow.

3

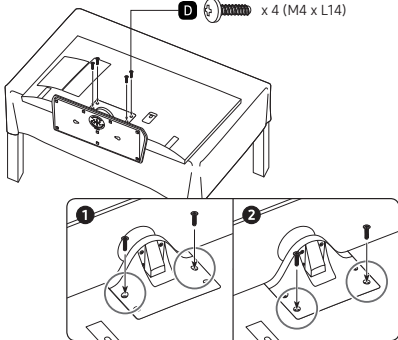

Tight the bottom screw first, and upper screw last.

- Progress the assembly of screw in the manual's order.

4

43"

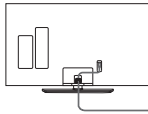

50"-55"

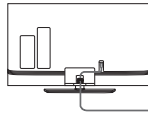

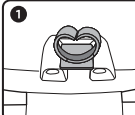
1 

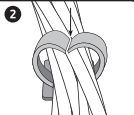
2 

NOTE

- Make sure to distinguish between the front and back of each component when assembling them.
- Make sure that at least two persons lift and move the TV.

Assembling the Stand and Components (65"-75")

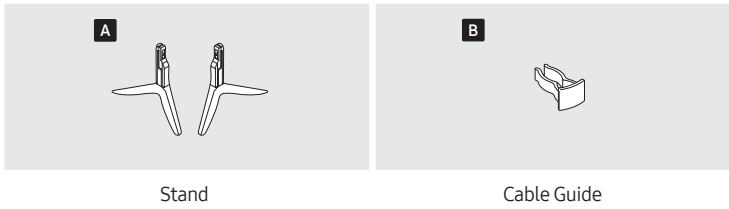

1

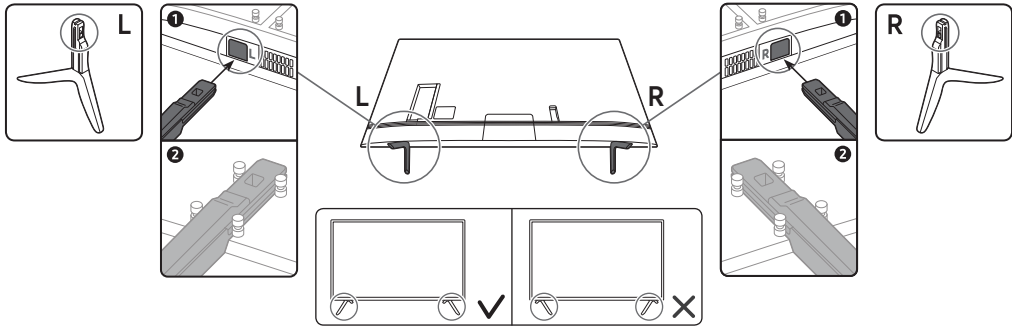

2

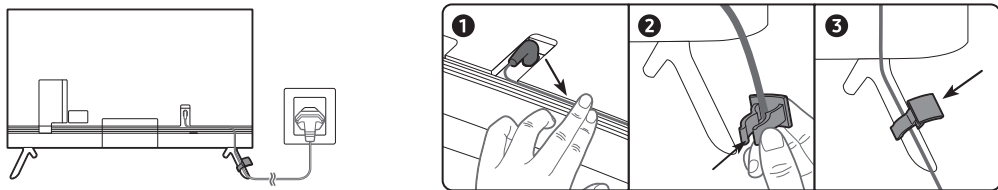

NOTE

- Make sure to distinguish between the front and back of each component when assembling them.
- Make sure that at least two persons lift and move the TV.

Assembling the Hotel Mount Kit (43" -55")

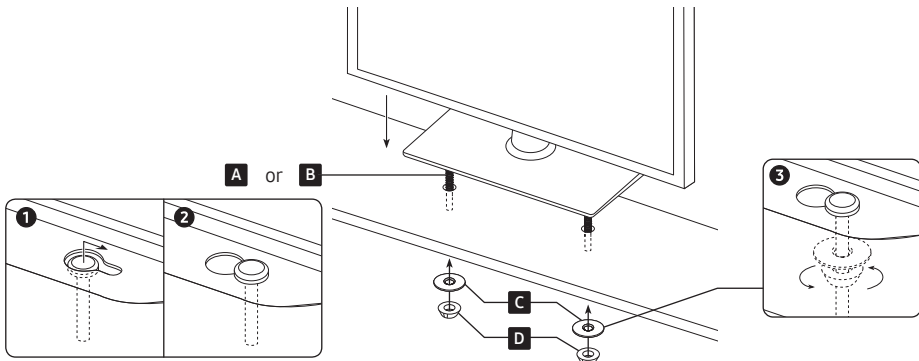
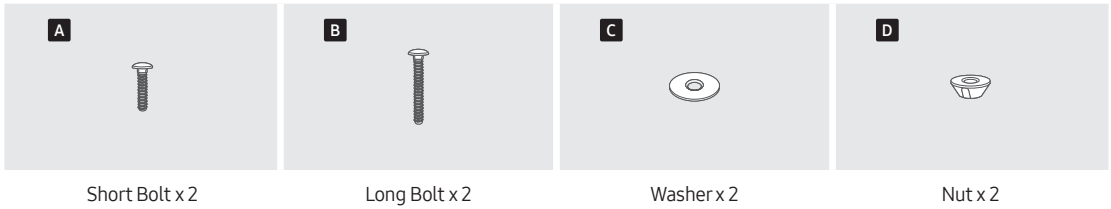

⚠ Affix the stand to a flat surface such as a dresser top, desk top, or entertainment centre as shown.



WARNING: To prevent injury, you must attach this TV securely to the floor, a table, a dresser top, etc. with the Hotel Mount Kit as described in these instructions.

Installing the wall mount kit

You can mount the TV on the wall using a wall mount kit (sold separately).

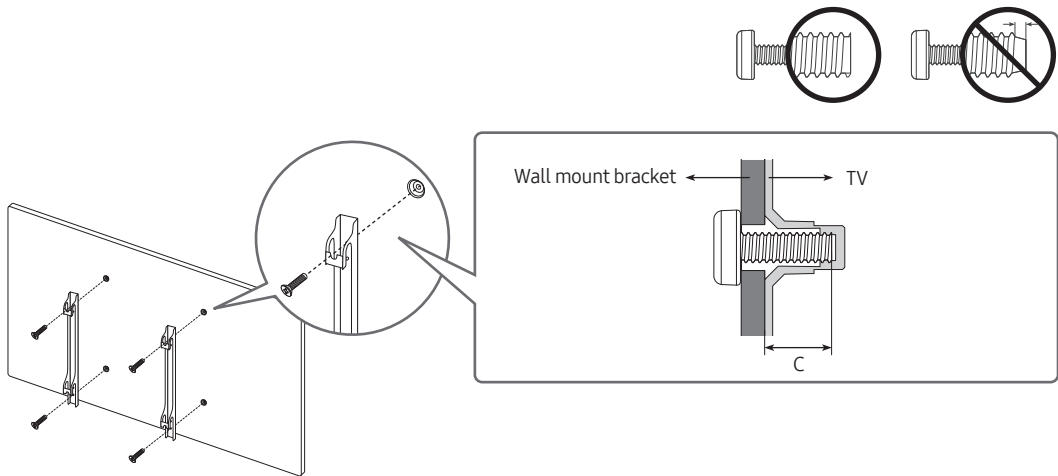

- The Product shape may differ depending on the model.

The wall mount kit (sold separately) allows you to mount the TV on a wall.

For detailed information on installing the wall mount, see the instructions provided with the wall mount. Contact a technician for assistance when installing the wall mount bracket. Samsung is not responsible for any damage to the product or injury to yourself or others if you select to install the TV on your own.

Securing the TV to the Wall



Caution: Pulling, pushing, or climbing on the TV may cause the TV to fall. In particular, ensure your children do not hang on or destabilise the TV. This action may cause the TV to tip over, causing serious injuries or death. Follow all safety precautions provided in the Safety Flyer included with your TV. For added stability and safety, you can purchase and install the anti-fall device.

Preventing the TV from falling

1. Using the appropriate screws, firmly fasten a set of brackets to the wall.
Confirm that the screws are firmly attached to the wall.
 - You may need additional material such as wall anchors depending on the type of wall.
2. Using the appropriately sized screws, firmly fasten a set of brackets to the TV.
 - For the screw specifications, refer to the standard screw part in the table under "Wall Mount Kit Specifications (VESA)".
3. Connect the brackets fixed to the TV and the brackets fixed to the wall with a durable, heavy-duty string, and then tie the string tightly.
 - Install the TV near the wall so that it does not fall backwards.
 - Connect the string so that the brackets fixed to the wall are at the same height as or lower than the brackets fixed to the TV.

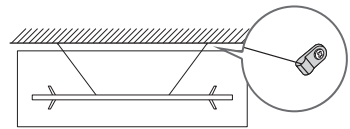
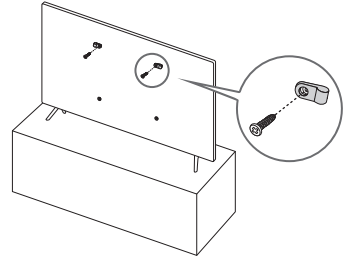

- The product colour and shape may vary depending on the model.

Wall Mount Kit Specifications (VESA)

Install your wall mount on a solid wall perpendicular to the floor. If you are attaching the wall mount to building materials other than plaster board, contact your nearest dealer. If installed on a ceiling or slanted wall, the TV may fall and cause severe personal injury.

- The wall mount kit is not supplied, but sold separately.
- NOTE
 - Standard dimensions for wall mount kits are shown in the table below.
 - Samsung wall mount kits contain a detailed installation manual. All parts necessary for assembly are provided.
 - Do not use screws that do not comply with the VESA standard screw specifications.
 - Do not use screws that are longer than the standard dimension or do not comply with the VESA standard screw specifications. Screws that are too long may cause damage to the inside of the TV set.
 - For wall mounts that do not comply with the VESA standard screw specifications, the length of the screws may differ depending on the wall mount specifications.
 - Do not fasten the screws too firmly. This may damage the product or cause the product to fall, leading to personal injury. Samsung is not liable for these kinds of accidents.
 - Samsung is not liable for product damage or personal injury when a non-VESA or non-specified wall mount is used or the consumer fails to follow the product installation instructions.
 - Do not mount the TV at more than a 15 degree tilt.
 - Always have two people mount the TV onto a wall.

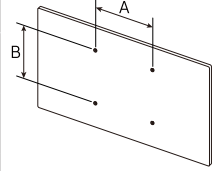
TV size in inches	VESA screw hole specs (A * B) in millimetres	C (mm)	Standard Screw	Quantity	
43-55	200 x 200	20-22	M8	4	
65	400 x 300				
75	400 x 400				



Do not install your wall mount kit while your TV is turned on. This may result in personal injury from electric shock.

Providing proper ventilation for your TV

When you install your TV, maintain a distance of at least 10 cm between the TV and other objects (walls, cabinet sides, etc.) to ensure proper ventilation. Failing to maintain proper ventilation may result in a fire or a problem with the product caused by an increase in its internal temperature.

- When you install your TV with a stand or a wall mount, we strongly recommend you use parts provided by Samsung only. Using parts provided by another manufacturer may cause difficulties with the product or result in injury caused by the product falling.

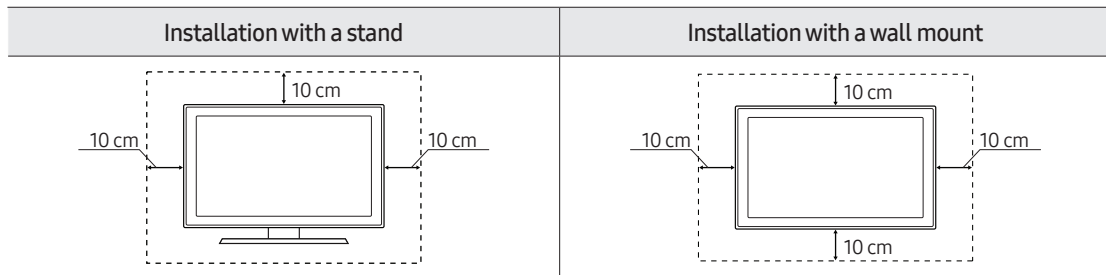

03 The Remote Control

About the Buttons on the Remote Control

- The images, buttons, and functions of the remote control may differ depending on the model.
- The remote control has Braille points on the **Power**, **Channel**, **Volume**, and **Select** buttons and can be used by visually impaired persons.
- If you use the remote control that comes with your TV to control another TV, some functions may not operate normally.

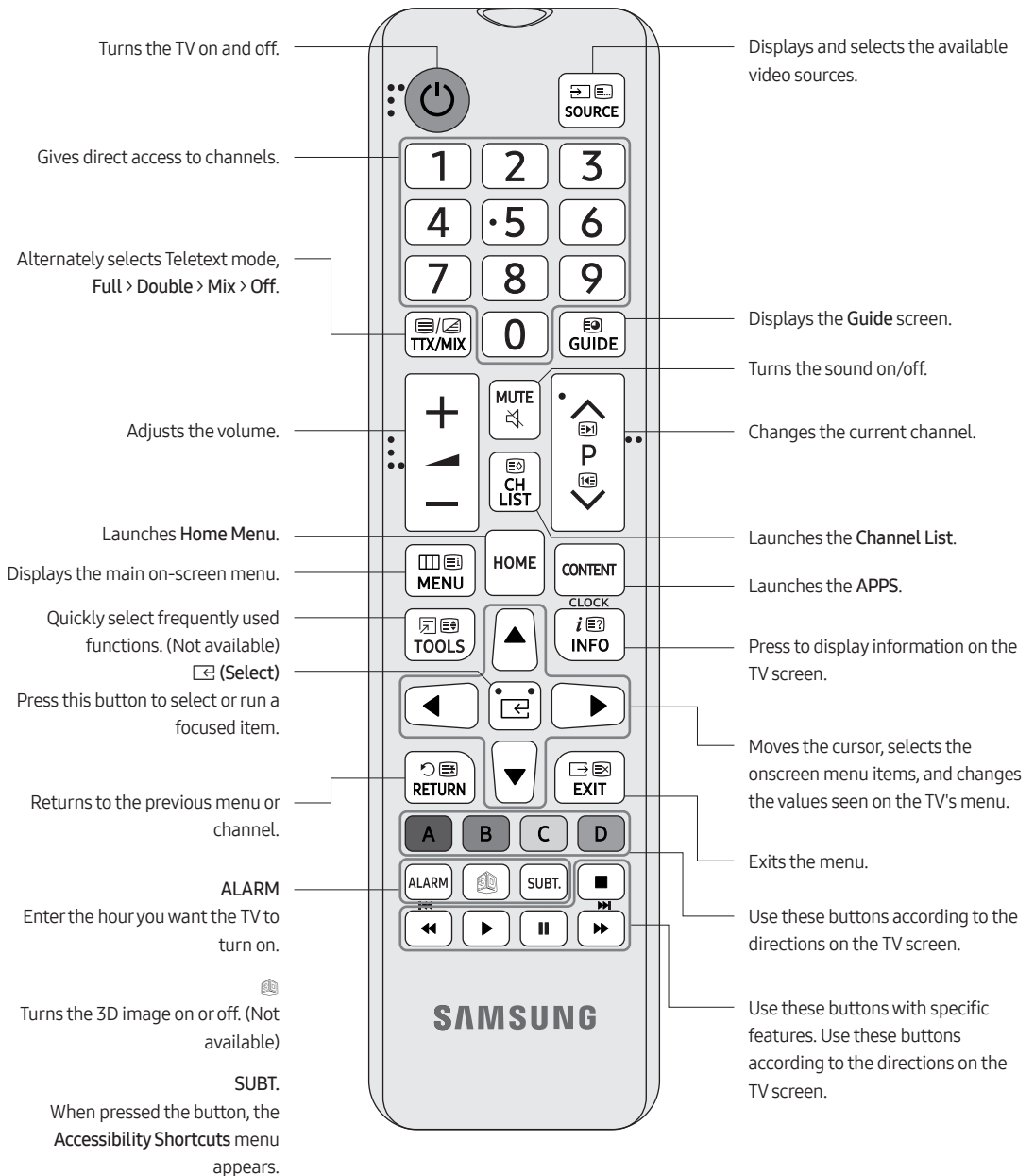

Installing batteries into the remote control (Battery size: AAA)

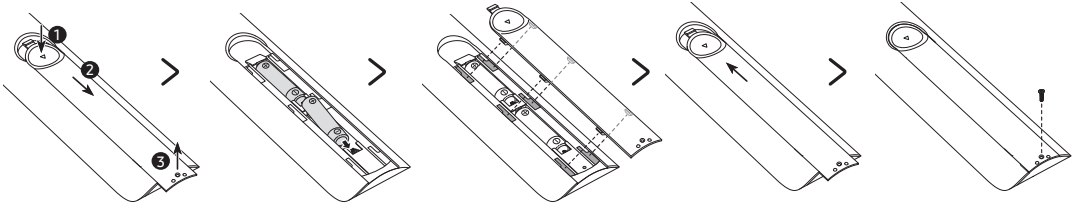

Match the polarity of the batteries to the symbols in the battery compartment.

- Use the remote control within 7 m of the TV.
- Bright light may affect the performance of the remote control. Avoid using near bright fluorescent lights or neon signs.
- The colour and shape of the remote may vary depending on the model.

04 Initial Setup

When you turn on your TV for the first time, it immediately starts the Initial Setup. Follow the instructions displayed on the screen and configure the TV's basic settings to suit your viewing environment.

If you already completed the Initial Setup, run the Initial Setup again using the following menu.

- **Hotel Option (MUTE > 1 > 1 > 9 > Select [OK]) > System > TV Reset**

If you select **TV Reset**, the TV resets all values to their factory defaults. When the TV turns off, press the **POWER** button on the remote control to turn on the TV. The TV starts the Initial Setup.

- The image on your TV may differ from the image below depending on the model and geographical area.

1

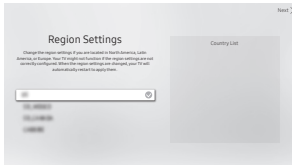

Select the region settings

- Before select region, refer to the country list information on the right.
- If you select the incorrect region, execute **TV Reset** again after the Initial Setup is completed.
- If the region is changed, the TV automatically turns off and on.

2

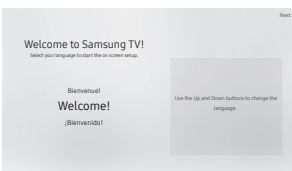

Selecting your language

You can change the menu language.

3

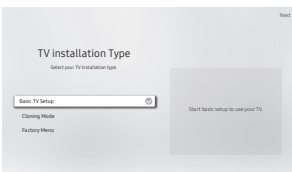

Selecting your TV installation type

- **Basic TV Setup:** Select to proceed to the next step to set the basic options for using your TV.
- **Cloning Mode:** Copy the system settings from the USB or server to the TV.
- **Factory Menu:** End Initial Setup and go to **Hotel Option** menu directly.
- If you select the incorrect **TV installation type**, execute **TV Reset** again after the Initial Setup is completed.

4

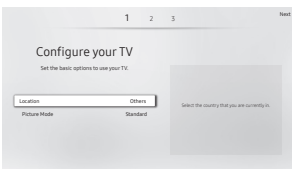

Setting basic options for using your TV

- **Location:** You can select the country that you are currently in.
- **Picture Mode:** You can select the picture mode that provides the best viewing experience.

5



Selecting the broadcasting signal

- You can selecting the connected aerial that you want to use to get channels.

6

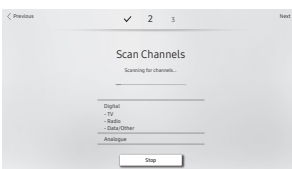

Scanning Channel

- After channel sanning is completed, select **Next** or press the right directional button on the remote control.
- When the RF cable is not connected, this step is skipped.

7

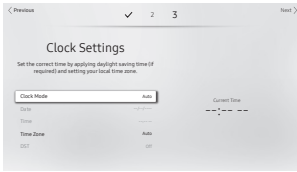

Setting the current time

- If the TV will be tuned to digital broadcast channels, and these channels transmit date and time information, set the **Clock Mode** to **Auto**. The TV will set the date and time automatically.
- If the TV will not be tuned to digital broadcast channels, set the **Clock Mode** to **Manual**, and then set the date and time on the TV manually.
- Set **DST** (Daylight Saving Time) to **On** or **Off** to apply to the TV.
- Select your time zone.
- **GMT** (Greenwich Mean Time) is activated only when configuration is made for a limited area.

8



Setup complete

Select the **Done** button to complete the Initial Setup. Then **Hotel Option** menu appears. Press **POWER** button to exit.

Using the TV Controller

You can turn on the TV with the **TV Controller** button at the bottom of the TV, and then use the **Control menu**. The **Control menu** appears when the **TV Controller** is pressed while the TV is On. For more information about its usage, refer to the figure below.

- The screen may dim if the protective film on the **SAMSUNG** logo or the bottom of the TV is not detached. Please remove the protective film.

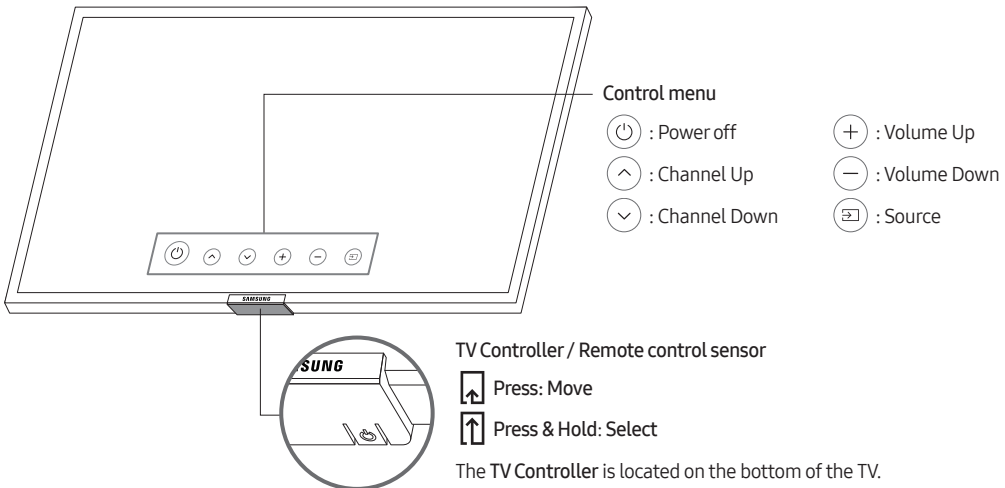

05 The Connection Panel

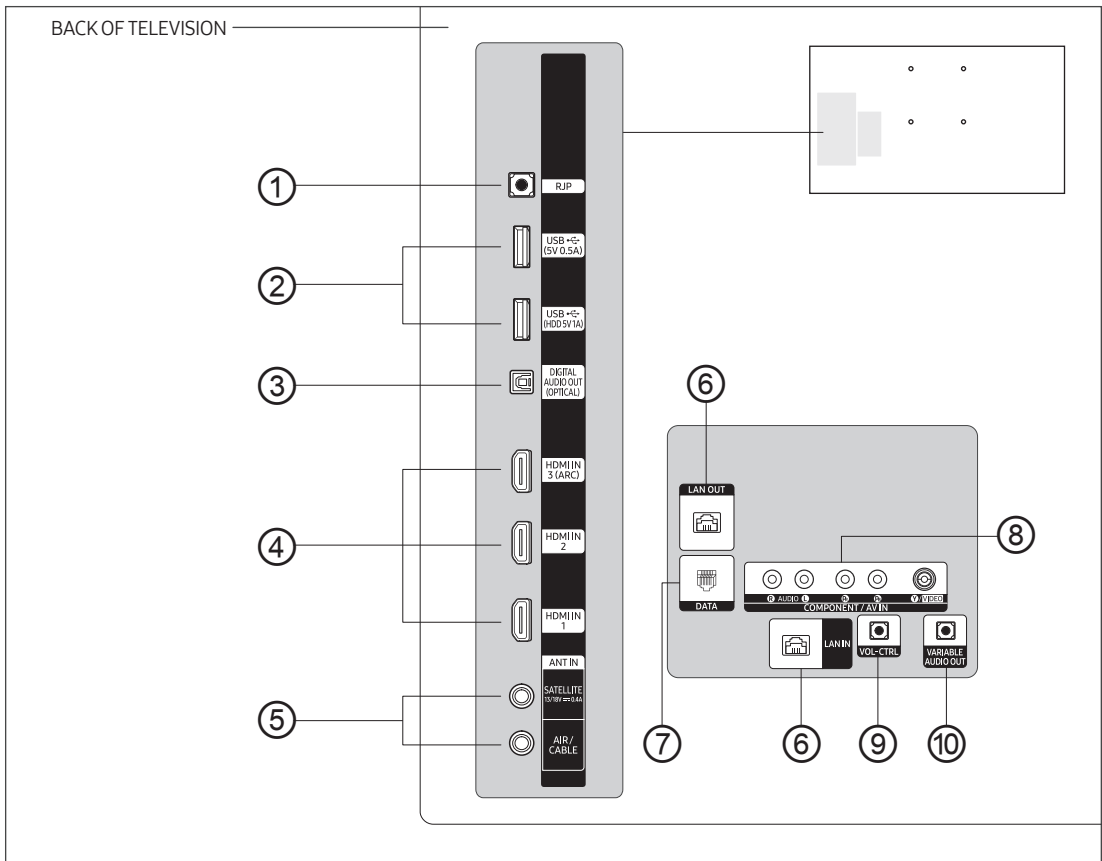

- Whenever you connect an external device to your TV, make sure that power on the TV and the device is turned off.
- When connecting an external device, match the colour of the connection terminal to the cable.

① RJP

Connect this port to the port on the optional RJP (Remote Jack Pack). This will allow you to connect external devices (Camcorder, PC, DVD players etc.) easily.

② USB (5V 0.5A), USB (HDD 5V1A)

- Connector for software upgrades and Media Play, etc.
- Service connection.

③ DIGITAL AUDIO OUT (OPTICAL)

Connects to a Digital Audio component.

④ HDMI IN 1, 2, 3 (ARC)

Connects to the HDMI jack of a device with an HDMI output.

- No separate sound connection is needed for an HDMI to HDMI connection. HDMI connections carry both audio and video.
- It is recommended that the external device of the HDMI 1.3 or 1.4 version will be used with this TV. If you meet the compatible problem like no sound or the abnormal screen or etc with the device of the HDMI 1.2 version, contact to the Samsung customer care centre.

⑤ ANT IN (SATELLITE), (AIR/CABLE)

- To view television channels correctly, the TV must receive a signal from one of the following sources:
- An outdoor antenna / A cable television system / A satellite receiver

⑥ LAN IN / LAN OUT

Connect to a wired LAN using CAT 7 (*STP type) cable.

* Shielded Twisted Pair

⑦ DATA

- Used to support data communication between the TV and the SBB or STB.
- Connects using RJ-12 TV type plugs.

⑧ COMPONENT IN / AV IN

- Use to connect to Component video / audio devices such as DVD players and AV (Composite) devices such as VCRs.
- Connect audio cables to **R-AUDIO-L** on your TV and the other ends to corresponding audio out ports on AV (Composite) devices.
- Connect component video cables (not supplied) to the component ports (**PR, PB, Y**) on your TV and the other ends to corresponding component video out ports on a DVD player. Match the colours on the ports and cables.
- If you want to connect both a set-top box and a DVD player, you should connect the set-top box to the DVD and connect the DVD to the component ports (PR, PB, Y) on your TV.
- The PR, PB and Y ports on your component devices (DVD) are sometimes labelled **R-Y, B-Y** and **Y** or **Cr, Cb** and **Y**.
- For AV (Composite), connect RCA audio cables (not supplied) to **R-AUDIO-L** on your TV set and the other ends to corresponding audio out ports on an external device.
- When you are connecting a AV (Composite) device to **AV IN [Y/Video]**, connect the video cable (yellow) to the **AV IN [Y/VIDEO]** port (green/yellow).

⑨ VOL-CTRL

Used to control the volume of the Bathroom speaker. Connect the Bathroom Wall Box and the **VOL-CTRL** port.

⑩ VARIABLE AUDIO OUT

Used for the audio output to the Bathroom speaker. Connect the Bathroom Wall Box and the **VARIABLE AUDIO OUT** port.

06 Connections

Connecting to your Internet network

You can set up your TV so that it can access the SMART TV applications through your local area network (LAN) using a wired or wireless connection.

- After you have physically connected your TV to your network, you must configure the network connection to complete the process. You can configure the connection after the Initial Setup process, through the TV's menu.

Establishing a wireless Internet connection

Connect the TV to the Internet using a standard wireless router or modem.

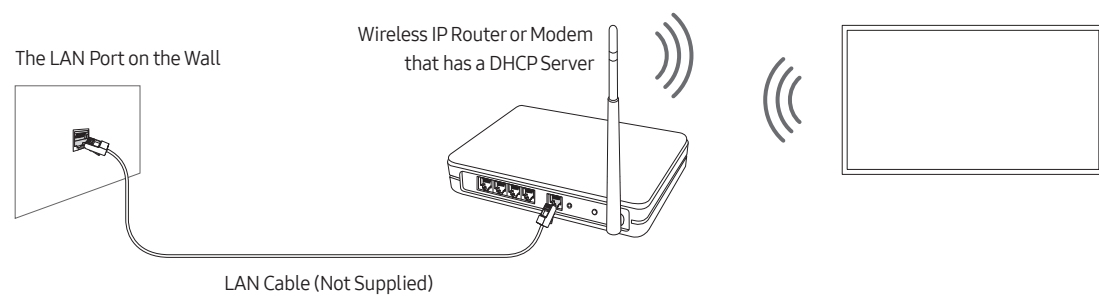

- This Smart TV supports the IEEE 802.11a/b/g/n communication protocols. Samsung recommends using IEEE 802.11n. Otherwise, when you play video over a network connection, the video may not play smoothly.
- To use a wireless network, the TV must be connected to a wireless router or modem. If the wireless router supports DHCP, the TV can use a DHCP or static IP address to connect to the wireless network.
- Select a channel that is not currently in use for the wireless router. If the channel set for the wireless router is currently being used by another device, the result is usually interference and/or a communications failure.
- Most wireless networks have an optional security system. To enable a wireless network's security system, you need to create a security key using characters and numbers, and then enter that key into the router through its menu. You then must enter this security key into any other devices you want to connect to the wireless network.

Network Security Protocols

The TV only supports the following wireless network security protocols:

- Authentication Modes: WEP, WPAPSK, WPA2PSK
- Encryption Types: WEP, TKIP, AES

In compliance with the newest Wi-Fi certification specifications, Samsung TVs do not support WEP or TKIP security encryption in networks running in the 802.11n mode.

If the wireless router supports WPS (Wi-Fi Protected Setup), you can connect the TV to your network using PBC (Push Button Configuration) or a PIN (Personal Identification Number). WPS automatically configures the SSID and WPA key settings.

Your Smart TV cannot connect to uncertified wireless routers.

Establishing a wired Internet connection

There are three main ways to connect your TV to your network using cable, depending on your network setup. They are illustrated below:

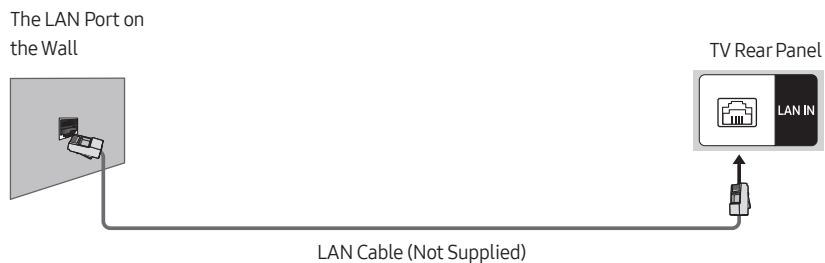
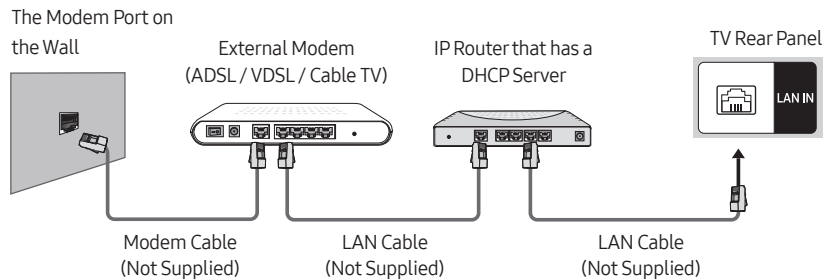
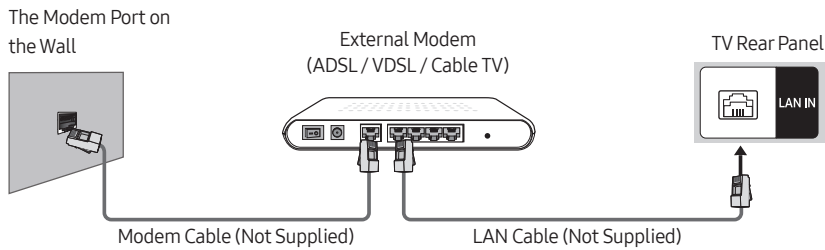

- The TV will not be able to connect to the Internet if your network speed is below 10 Mbps. (The TV does not support network speeds less than or equal to 10Mbps.)
- Use CAT 7 (*STP type) cable for the connection.
 - * Shielded Twisted Pair

Connecting the TV to an SBB or STB

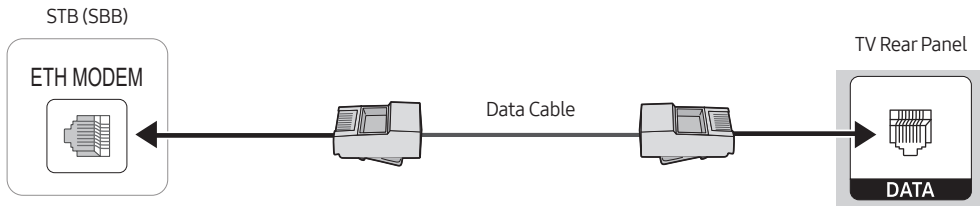

Connect the DATA port of the TV to the ETH MODEM port of the STB (SBB) with the Data cable.

- The ETH MODEM port name that you connect the Data Cable to may differ depending on the SBB or STB type.
- The remote control IR signal need to meet the following specification to use IR pass through function.

IR signal reciever specification

- Band pass filter centre frequency: 37.9 kHz
- Carrier Frequency, Duty 50%
- Minimum Burst Length (tburst): 12 pulses (316 us)
- Minimum Gap Time Between the burst (tburst gap): 16 pulses (422 us)
- Minimum Gap Time between the data commands (tpause): 25 ms

Compatible Data Cables Supplied with the TV

- Confirm you are using the correct data cable for your vendor. Refer to the code label on the data cables.

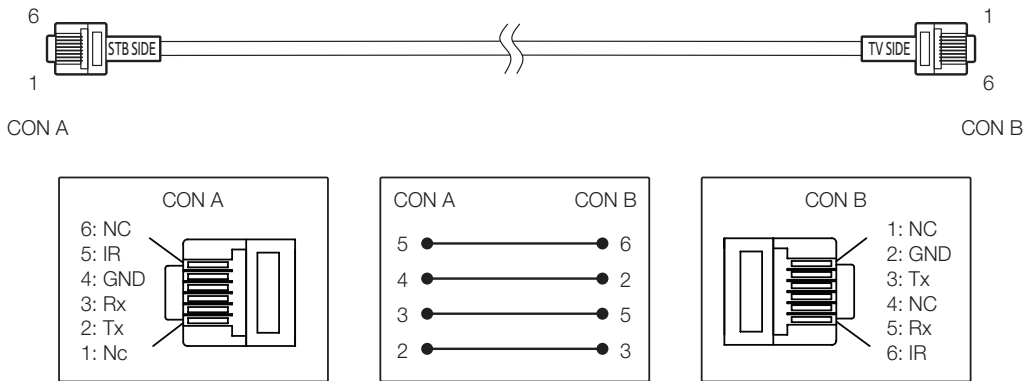

- Operation Specification of Data Cable(RJ12) : RS232

Connecting the Bathroom Speakers

You can connect the Bathroom Speakers using the following method.

Connecting through the Variable Output (available without an external amplifier)

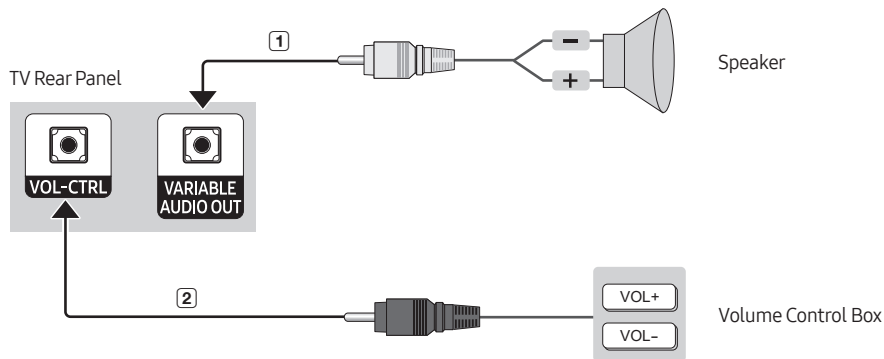

- The rear panel may differ depending on the model.

① Connect the **VARIABLE AUDIO OUT** port of the TV to the Bathroom Wall Speakers of the hotel.

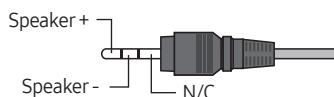

② Connect the **VOL-CTRL** port of the TV to the Volume Control Box Switch port on the Bathroom Wall of the hotel.

- The maximum speaker output is 4W, 8Ω.
- The **VARIABLE AUDIO OUT** port supports **MONO** sound out only.

- Installing the Volume Control

- If you configure the Volume Control Box as shown in the figure, you can control the volume of the bathroom speakers.
- The port that connects the Volume Control Box to the TV is a 3.5mm normal Phone jack.
- Volume Control Box switch is a Tact switch.

- Setting the Sub AMP Mode

- **0**: Turns the Sub AMP function off (PWM off).
- **1**: Determines the Sub volume according to the main volume control. The sub volume is determined according to the Power On Volume, the Min Volume, and the Max Volume values of Hotel Mode.
- **2**: Determines the volume according to the bathroom control panel setting.

- Variable Output Port Specifications

- **Speaker Wire**: Use speaker cable no more than 25 m in length.

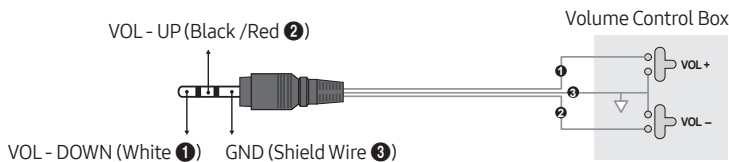

Connecting the RJP (Remote Jack Pack)

Connect the input jacks on the TV to the RJP. The RJP lets guests connect audio and video sources to the TV.

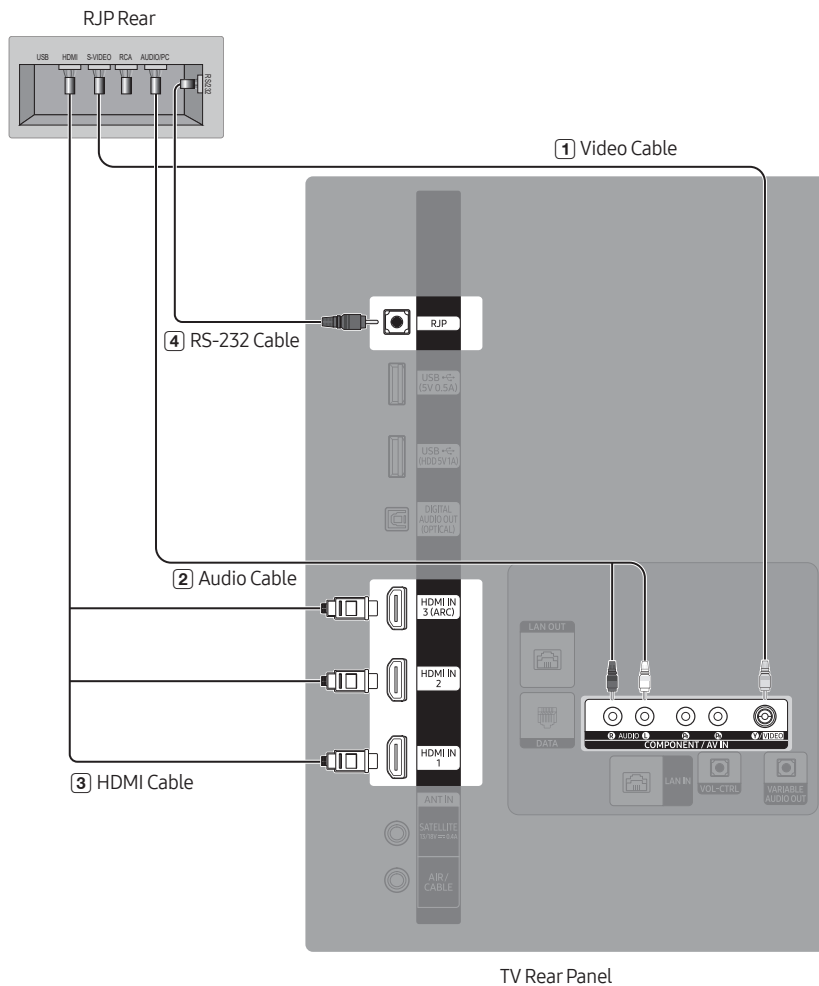

- The rear panel may differ depending on the model.
- 1 Connect the AV IN [Y/VIDEO] port of the TV to the S-VIDEO port of the RJP.
- 2 Connect the [R-AUDIO-L] port of the TV to the AUDIO/PC port of the RJP.
- 3 Connect the HDMI port of the TV to the HDMI port of the RJP.
- 4 Connect the RJP port of the TV to the RS/232 port of the RJP.
 - This Samsung TV is compatible with the TeleAdapt TA-7610 RJP only.

- **RJP (Remote Jack Pack):** The RJP is a hardware module that has various audio and video inputs (A/V video, A/V audio, PC and HDMI) and corresponding outputs. The corresponding outputs are connected from the RJP to the TV. The RJP communicates with the TV via RS232. The RJP communicates with the TV by sending messages regarding active or inactive sources.
 - A group of **Hotel Option** menu items let you assign numbered priorities to the jacks of the RJP. 1 is the highest priority and 2 is the lowest. When a guest connects external sources to the RJP jacks, the TV will automatically switch between sources based on the priority you have assigned them in the **Hotel Option** menu. For example, lets say AV is set to 1 and HDMI to 2. If a guest has attached a device to the HDMI jack, and then plugs a device into the AV jack, the TV automatically switches to the device plugged into the AV jack (the jack with the higher priority). Note that a guest can also switch between devices manually by pushing a button on the RJP.
- To reset the RJP to its factory default state, press the AV and HDMI buttons simultaneously for 10 seconds. When all button LEDs blink 5 times, the RJP reset is complete.
- The RJP will automatically turn off any LEDs after 5 minutes to avoid unnecessary light pollution in the hotel room. The LEDs that were turned off will turn on again if the guest touches any of the buttons and the 5 minute timer will restart. If the guest then touches another source button, the TV will change to the selected source and the corresponding LED will be lit.
- After the RJP reset or the TV turns off/on, it takes approximately 10 seconds to establish communications between the TV and the RJP.
- The following table shows the approximate time in seconds it takes to switch from the TV to an input source, based on assigned or default priorities.
 - When no inputs are connected.

Source	To Connect
AV	2 sec
HDMI	3.9 sec

- When two or more inputs are connected to the RJP and one of the input sources is disconnected and then reconnected.

Source	Disconnect	To Connect	Total
AV	4.5 sec	2 sec	6.5 sec
HDMI	3.9 sec	3.9 sec	7.8 sec

- If the RJP has all its live sources (AV, PC, and HDMI) connected, AV has been assigned the highest priority, the RJP is in HDMI mode, and a guest removes and reconnects the AV source, the minimum time required to switch to the AV source is 6.5 seconds.
- To play audio devices (Ipods, MP3 devices, etc.) through the RJP, you must turn **Music Mode AV** in the menu on.
- Music mode in the TA-7610 RJP is supported by the AV jack only. **HDMI Music Mode** is available for the Guestlink RJP only.

07 Using a TV Viewing Card (“CI or CI+ Card”)

Watches paid channels by inserting your TV viewing card into the COMMON INTERFACE slot.

- The 2 CI card slots may not be supported depending on the model.
- Turn the TV off to connect or disconnect a “CI or CI+ Card”.
- The TV Viewing Card (“CI or CI+ Card”) may not supported depending on the model.

Connecting the “CI or CI+ Card” via COMMON INTERFACE slot with the CI CARD Adapter

Attaching the CI CARD Adapter via COMMON INTERFACE slot

To attach the CI CARD Adapter to the TV, follow these steps:

- ① Insert the CI CARD Adapter into the two holes on the back of TV.
 - Please locate the two holes at the back of the TV above the COMMON INTERFACE slot.
- ② Connect the CI CARD Adapter to the COMMON INTERFACE slot on the back of TV.

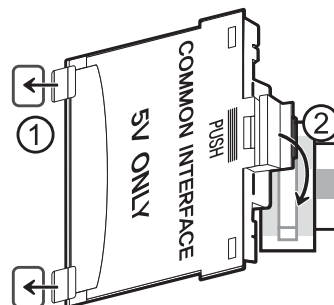

Connecting the “CI or CI+ Card”

Connect the “CI or CI+ Card” to the COMMON INTERFACE slot as shown in the image below.

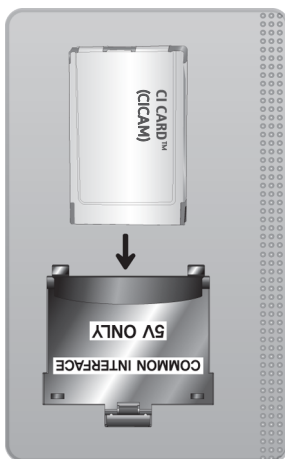

Connecting the “CI or CI+ Card” via COMMON INTERFACE slot

Connect the “CI or CI+ Card” to the COMMON INTERFACE slot as shown in the image below.

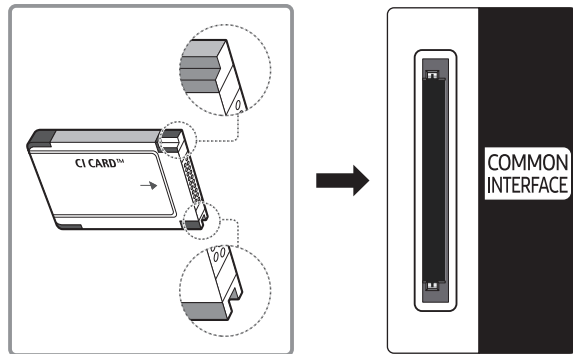

Using the “CI or CI+ Card”

To watch paid channels, the “CI or CI+ CARD” must be inserted.

- Samsung TV follow up CI+ 1.4 standard. When TV product display the pop-up message, it may happen due to CI+ 1.4 Version inconsistency. If you have a problem, please contact Samsung Call Centre.
 - Your Samsung TV conforms to the CI+ 1.4 standards.
 - Where a CI+ Common Interface module is incompatible with this device then please remove the module and contact the CI+ operator for assistance.
- If you don't insert the “CI or CI+ CARD”, some channels will display the pop-up message.
- The pairing information will be displayed in about 2-3 minutes. If an error message is displayed, please contact your service provider.
- When the configuration of channel information has finished, the message “Updating Completed” is displayed, indicating the channel list is updated.
 - You must obtain a “CI or CI+ CARD” from a local cable service provider.
 - When removing the “CI or CI+ CARD”, carefully pull it out with your hands since dropping the “CI or CI+ CARD” may cause damage to it.
 - Insert the “CI or CI+ CARD” in the direction marked on the card.
 - The location of the COMMON INTERFACE slot may be different depending on the model.
 - “CI or CI+ CARD” is not supported in some countries and regions; check with your authorised dealer.
 - If you have any problems, please contact a service provider.
 - Insert the "CI or CI+ CARD" that supports the current aerial settings. If not, the screen may not look normal.

08 Setting the Hotel Option Menus

To access the **Hotel Option** menus, press **MUTE > 1 > 1 > 9 > Select**  buttons on your remote control.

To control the TV functions in the **Hotel Option** menu, the TV has two modes, the **Standalone** mode and the **Interactive** mode. The menu items that differ between the modes are listed below. All other items appear in both modes.

Menu items in the **Standalone** mode only:

- **SI Vendor:** Movielink / Swisscom / Smoovie / SSCP
- **Network / DRM / Home Menu / REACH Solution / H.Browser Solution / HMS / Virtual Standby / Room Number** and its submenus.

Menu items in the **Interactive** mode only:

- **SI Vendor:** Samsung and other vendors.

After a menu appears, follow these general directions to navigate and change values:

- Use the directional buttons on the remote control to move from menu item to menu item.
- Press the **Select**  button on the remote control to select a menu item. The screen displays that menu item only.
- Press the left or right directional button to change a value. The right directional button increases numerical values. The left arrow button decreases numerical values.
- When the screen is displaying one menu item, you can press the up or down directional button to display the next or previous menu item.
- Press the **RETURN** or **MENU** button to exit the current menu item and go to a higher menu level or the main menu.
- To exit a **Hotel Option** menu, turn off the TV, and then turn it on again. Any changes you made are saved except SI (System Integration) vendor. For changes to SI vendor, you must turn the TV off, wait until the power indicator at the bottom of the TV glows steadily. And then unplug the TV, wait for the power indicator to go off, and then plug the TV in again.

To change menus between the **Interactive** mode and the **Standalone** mode, follow the steps below:

1. Highlight the **Hospitality Mode** menu item in the top left corner of the menu.
2. Press the **Select**  button on the remote control. Only the **Hospitality Mode** menu item is displayed.
3. Press the left or right directional button to change the **Hospitality Mode** item from **Standalone** to **Interactive** or from **Interactive** to **Standalone**.
4. Press the **RETURN** or **MENU** button on the remote control. The entire menu re-appears with your selection displayed in the **Hospitality Mode** field.
 - After you have set the values in one TV, you can clone those values to multiple TVs.
 - For more information about the USB cloning refer to page 44.

Hotel Option menu items

To enter this menu, press the **MUTE > 1 > 1 > 9 > Select**  buttons on the remote control in order.

To exit from this menu, turn off (or turn off and unplug the power cable if you have changed SI vendor) the TV, and then turn on again. Any changes you made are saved.

- The menu items may not be supported depending on the models and SI vendor.

Hotel Option menu Item	Description	
Hospitality Mode	Select Hospitality Mode . <ul style="list-style-type: none"> • Interactive: TV works with an SI STB or SBB. • Standalone: TV works alone, without an SI STB or SBB. 	
SI Vendor	<ul style="list-style-type: none"> • Interactive: Samsung / 2M / Locatel / VDA / VDA-S / Acentic / Sustinere / Quadriga / ETV / IBahn / Magilink / Otrum / Siemens / Amino / MDC / Enseo • Standalone: OFF / Movielink / Swisscom / Smoovie / SSCP 	
Power On	Power On Channel	Set the channel to display when the TV is turned on. <ul style="list-style-type: none"> • User Defined: Lets you set the channel number manually. See Power On Channel Num or Power On Channel Type below. • Last Saved: If you select this item, when the TV is turned on, it displays the channel it was displaying when it was turned off.
	Power On Channel Num	When the TV is turned on, it switches automatically to this channel.
	Power On Channel Type	Select the type of the channel will be displayed when the TV is turned on. ATV (analogue aerial band), DTV (digital aerial band), CATV (analogue cable band), CDTV (digital cable band), SDTV (digital satellite band).
	Power On Volume	<ul style="list-style-type: none"> • User Defined: Lets you set volume level manually. • Last Saved: When the TV is turned on, it returns to the volume that had been set when the power had been turned off.
	Power On Volume Num	The TV turns on with set volume level in Standalone mode.
	Min Volume	The minimum volume level the user can set in Standalone mode.
	Max Voume	The maximum volume level the user can set in Standalone mode.
	Power On Source	Select the input source to display when the TV is turned on.
Power On Option	Determines the TV's state when power returns after a power failure or after you have unplugged the TV and then plugged it in again. <ul style="list-style-type: none"> • Last Option: Returns to its last power state. If it was in standby mode, it returns to standby mode. If it was on, it turns on. • Power ON: When the power returns, the TV turns on. • Standby: When the power returns, the TV enters the standby mode. 	

Hotel Option menu Item	Description	
Channel	Channel Setup	Gives you direct, immediate access to some of the channel menu functions on the Broadcasting menu such as Auto Tuning , Audio Options , etc.
	Channel Editor	<p>Lets you edit the channels stored in the TV's memory.</p> <ul style="list-style-type: none"> • Change the channel numbers and names, manage genre and language groups and delete channels. • Apply the Screen Off to channels you select. The Screen Off blanks out the video from a channel and outputs only audio. • Lets you view information about each channel easily, without your having to display each channel directly.
	Channel Bank Editor	<p>Edits channels, with 3 different Bank options. There are specific channels customers can enjoy, depending on the Bank card.</p> <ul style="list-style-type: none"> • This function is only available when set to Hospitality Mode: Standalone, SI Vendor: Smoovie.
	Mixed Channel Map	<p>Enables showing/browsing all antenna type (Aerial/Cable or Satellite) channels at the same time.</p> <ul style="list-style-type: none"> • ON: When set to on, guests can access the complete channel map irrespective of the selected antenna type. The Channel List/Channel Editor will also populate Aerial as well Cable type channels. • OFF: When set to off, guest can access the channel map corresponding to the selected antenna type (Aerial/Cable or Satellite) only. The Channel List/Channel Editor will only show the selected antenna type channels.
	Dynamic SI	<ul style="list-style-type: none"> • ON: Do not check the DTV programme channel number. • OFF: Check the DTV programme channel number.
	Channel Rescan Message	<p>When there is a mismatch between the data in the channel map and the transmitted data, the TV autotunes the channels to restore the data/parameters in the channel map.</p> <ul style="list-style-type: none"> • ON: When Channel Rescan Message is set to on, the OSD showing that the channels are being rescanned will be displayed to the guest. • OFF: When Channel Rescan Message is set to off, if the rescan message OSD should not be displayed to the guests.
	Pan Euro MHEG	<ul style="list-style-type: none"> • OFF: If Pan Euro MHEG is set to Off, MHEG runs according to the existing product specifications. (E.g. MHEG runs for England, but MHEG does not run for France.) • ON: If Pan Euro MHEG is set to on, MHEG is on regardless of the product specifications or region. (Even if the region does not support MHEG, it is supported in case the hotel supports MHEG.)
	MyChannel	<p>Enable or disable the My Channel function.</p> <ul style="list-style-type: none"> • This function is not available when set to Hospitality Mode: Standalone, SI Vendor: Smoovie.

Hotel Option menu Item		Description
Channel	Subtitle Auto On	<p>This function turns the function on or off that automatically turns on the subtitles in a specific country.</p> <p>This function is supported for the TVs that are ready to receive DVB broadcasts that is heading to Europe.</p> <p>This function is related to France's subtitle specification. The rest of the subtitle functions available according to the country specifications regardless of Subtitle Auto On function.</p> <ul style="list-style-type: none"> • ON: When Subtitle Auto On is set to on, it follows France's subtitle specifications. • OFF: When Subtitle Auto On is set to off, it does not follow France's subtitle specifications.
	TTX Widescreen Mode	<p>ON: TTX should show in 16:9 picture size.</p> <p>OFF: TTX should show in 4:3 picture size.</p>
Menu OSD	Picture Menu Lock	Enable or disable the Picture menu.
	Menu Display	<ul style="list-style-type: none"> • ON: The main menu is displayed. • OFF: The main menu is not displayed.
	Channel Menu Display	<ul style="list-style-type: none"> • OFF: Broadcasting menu is disable for guest. • ON: Broadcasting menu is enable for guest.
	Panel Button Lock	<p>Turning the TV Controller button operations on or off.</p> <ul style="list-style-type: none"> • Unlock: Unlocks TV Controller button. • Lock: Locks TV Controller button. • OnlyPower: Locks TV Controller button except the power off function.
Clock	Local Time	<p>Select the way to update the clock data</p> <ul style="list-style-type: none"> • Standalone: Manual / TTX / Time Channel • Interactive: Manual / Auto / TTX / Time Channel <ul style="list-style-type: none"> – Manual: The clock is set automatically from the DTV channel or manually by the user when the TV is in Standalone mode. – TTX: Bring up the time information from the TTX stream. – Time Channel: The clock is set from the selected channel.
	Timer Type	<p>Enable or disable the alarm function.</p> <ul style="list-style-type: none"> • WakeUp: Enable the alarm function to turn on the device at the specified time. • OnOff: Disable the alarm function and enable on or off timer.
	Time Channel Type	<p>Select the type of the channel to update the clock data.</p> <ul style="list-style-type: none"> • This function is only available when Local Time set to Time Channel.
	Time Channel Num	<p>Select the number of the channel to update the clock data.</p> <ul style="list-style-type: none"> • This function is only available when Local Time set to Time Channel.
	NTP Settings	Set up the server URL and time zone to use the network time.

Hotel Option menu Item		Description
Music Mode	Music Mode AV	Allows music output from an mp3/audio player connected to an AV input source on the TV. When set to on, you can hear sound from the player through the TV whether there is a video signal or not. Also mutes the video so the TV does not display a picture when a guest is playing music. The TV's backlight, however, remains on.
	Music Mode Comp	Allows music output from an mp3/audio player connected to an component input source on the TV. When on, you can hear sound from the player through the TV whether there is a video signal or not. Also mutes the video so the TV does not display a picture when a guest is playing music. The TV's backlight, however, remains on.
	Music Mode Backlight	When set to off, the TV's backlight is turned off entirely when a guest is playing music through the external device. (ex. DVD player, USB flash drive) To save energy, set to off. To play the music through the external device, press the SOURCE button on the remote control, and then select external device icon.
Remote Jack Pack	Priority AV	Lets you set the priority of the 7610 RJP AV jack. You can choose 1, 2, with 1 being the highest and 2 the lowest. The TV automatically displays the source with the higher priority. For example, lets say AV is set to 1 and HDMI is set to 2. If a guest has attached a device to the HDMI jack, and then plugs a device into the AV jack, the TV will automatically switch to the device plugged into the AV jack (the jack with the higher priority). Note that a guest can also switch devices manually by pushing a button on the 7610 RJP.
	Priority HDMI	Lets you set the priority of the 7610 RJP HDMI jack. You can choose 1, 2, with 1 being the highest and 2 the lowest. The TV automatically displays the source with the higher priority.
	HDMI Option	Select which HDMI source of the TV is connected to the RJP jack. (HDMI1/HDMI2/HDMI3)
	HDMI Music Mode	Allows music output from an mp3/audio player connected to an HDMI input source. When set to on, you can hear sound from the player through an HDMI input of the RJP whether there is a video signal or not. <ul style="list-style-type: none"> This option is only compatible with the Guest link RJP.

Hotel Option menu Item		Description
External Source	USB Pop-up Screen	When USB is connected to the TV : <ul style="list-style-type: none"> • Default: A popup window appears. • Automatic: This enters the USB content menu automatically. • Disable: Neither the popup window nor the menu appears.
	External Source Banner	If set to on, the TV displays the External Source Banner (information) when you change the TV source to another external input, press the SOURCE button on the remote control, or turn on the TV. <ul style="list-style-type: none"> • ON: The External Source Banner (information) is displayed on the TV screen. • OFF: The External Source Banner (information) is not displayed on the TV screen.
	Auto Source	<ul style="list-style-type: none"> • ON: When an external input source is connected to the TV, the TV identifies the input source, and then automatically switches to that input source. • OFF: Auto Source function is disabled.
	Anynet+ Return Source	Select the source to return after stopping an Anynet+ (HDMI-CEC) connection. <ul style="list-style-type: none"> • This function is especially useful for the Guestlink RJP.
Bathroom Speaker	Sub Amp Mode	Determines the bathroom speaker sound AMP operation mode. <ul style="list-style-type: none"> • 0: Turns the bathroom speaker sound AMP function off (PWM off). • 1: The bathroom speaker sound volume follows the TV speaker sound volume identically. The bathroom speaker sound volume is controlled by the TV remote control or TV's panel buttons. • 2: The bathroom speaker sound volume is controlled by the bathroom speaker volume controller.
	Sub Amp Volume	The initial bathroom speaker sound volume after TV is turned on.
Eco Solution	Power Saving Mode	Adjusts the brightness of the TV to reduce power consumption. <ul style="list-style-type: none"> • OFF: Turns off the energy saving function. • Low: Sets the TV to low energy saving mode. • Medium: Sets the TV to medium energy saving mode. • High: Sets the TV to high energy saving mode.
	Power Saving Mode Timer	This function is only available when set to Hospitality Mode: Interactive, SI Vender: Magilink .

Hotel Option menu Item		Description
Logo/ Message	Welcome Message	Displays the welcome message for 60 seconds when the TV turns on.
	Edit Welcome Message	Edits the welcome message.
	Hospitality Logo	Turns the Hospitality Logo function is set to OFF, BMP, AVI, BOTH . If the function is not set to OFF , the TV is turned on, the logo is displayed, before the signal from the initial source, for the amount of time set in Logo Display Time . <ul style="list-style-type: none"> The DivX codec is not supported.
	Hospitality Logo DL	You can download the startup logo from the connected USB flash drive. Hospitality logo file requirements: <ul style="list-style-type: none"> Image or video files only. The image file is supported up to 2 MB. The video file is supported up to 50 MB. File can only be named "samsung_image.*", "samsung_video.*"
	Logo Display Time	Set the time displayed Hospitality Logo . (3/5/7 seconds).
Cloning	Clone TV to USB	Clone the current TV options to a USB memory device.
	Clone USB to TV	Clone the saved TV options on a USB memory device to the TV.
	Setting Auto Initialize	If you set Setting Auto Initialize to On , the TV menu items are restored again to their values cloned initially when the TV turns off and then on.

Hotel Option menu Item		Description
Network	Network Setup	<p>If this item is entered into, Network menu is displayed. The Network menu is used for setting network like internet access.</p> <ul style="list-style-type: none"> • Network Status: View the current network and Internet status. • Soft AP: Turns on or off the Soft AP. When Soft AP is set to on, your mobile devices can find the TV name in Wi-Fi connection list. <ul style="list-style-type: none"> – When the TV connected with wireless network, Soft AP is enabled. • Security key: Set a security key that you need to enter on other devices so they can connect to the TV. • Open Network Settings: Connect to an available network. <ul style="list-style-type: none"> – Input the generated security key into the device you want to connect. – If network does not operate normally, check the security key again. An incorrect security key may cause a malfunction. – Soft AP may not be available if it is not supported by the model. – Maximum number of devices that can be connected: 4 devices. – Bitrate: >10 Mbps/device. (The TV does not support network speeds less than or equal to 10Mbps.) – The specifications above are based on our in-house testing. Actual performance may vary depending on your wired/wireless network environment.
	Apps ID Setting	The feature to set specific Hotel ID for installing the app of the corresponding hotel in the Hotel TV.
	Apps Setting	Enters Samsung App Store for managing current apps and installing new apps in the Hotel TV.
	Service Discovery	Can use this feature to enable the function like DLNA.
	LAN OUT	Enable/disable LAN Out. When enabled, the TV can work as a wired router for other network devices.
	VLAN ID	Create separate VLAN (Virtual Local Area Network) groups. A 3-digit number can be entered between 1 and 255 for the VLAN ID.
	Solution VLAN ID	When VLAN (Virtual Local Area Network) is used, set a VLAN ID to be assigned to a Solution (such as SYNC, H.Browser etc.).
	Device LAN ID	Set a VLAN (Virtual Local Area Network) ID to be assigned to external devices connected to the LAN OUT port.
ARP Interval	<p>Adjust the ARP (Address Resolution Protocol) interval value.</p> <ul style="list-style-type: none"> • Setting value: 2 / 5 / 10 / 30 / 60 / 120 / 180 / 600 / 1800 / 3600 second (default: 60 sec) 	
System Manager	<p>Gives you direct and immediate access to System Manager menu such as such as Time, Language, Change PIN, etc.</p> <p>System Manager allow you to adjust your TV's system and customise settings for your viewing environment.</p>	

Hotel Option menu Item		Description
SI Config	TV Version	This function is only available when set to Hospitality Mode: Interactive , SI Vender: Magilink.
Security	Factory Lock	Disable entry to Hotel Option menu. <ul style="list-style-type: none"> • ON: The password is needed before entering Hotel Option menu. • OFF: Disable this function.
	Password Popup	Enable or disable password input popup window. If this option is set to off, the TV will not display the password input popup window when entering the Hotel Option menu. If set to on, the password input popup window appears.
	Password Input	If this function is enabled, the password input popup window appears which asks for an 8-character security password. The admin must enter a password before applying or updating security preferences. After the correct password is entered, options such as Password Setting , Password Reset and Security Mode are available.
	Password Setting	User can change the password.
	Password Reset	Password is reset to "00000000".
	Security Mode	Provides password protected administrative functionality to enable or disable features of hospitality TV, such as USB , HDMI . To use this option, Security Mode set to on. After Security Mode set to on, options such as USB , HDMI are automatically enabled. Clone USB to TV and TV Reset will be disabled in the Hotel Option menu.
	USB	Enable or disable USB access. If this function is set to disable, access to USB media is blocked.
	HDMI	Enable or disable HDMI access. If this function is set to disable, Anynet, HDMI source, HDMI type external channels will not be accessible to the user.
DRM	TTX Security	If this option is disabled, the TTX feature will not work when the TTX button is pressed on the remote control.
	DRM Mode	Configures DRM support. <ul style="list-style-type: none"> • This function is only available when SI Vender set to Acentic. • OFF: Turns off DRM support. • LYNK DRM: Select to turn on S-LYNK DRM CAS support only.

Hotel Option menu Item	Description
System	<p>Self Diagnosis for TV</p> <p>Enter Self Diagnosis Menu.</p> <ul style="list-style-type: none"> • Start Picture Test: Use this test when you experience a problem with your TV's picture. • Start Sound Test: Use this test when you experience a problem with your TV's sound. • Signal Information: Show digital broadcasting signal information. • Reset Smart Hub: Reset the Smart Hub and Samsung account settings stored on your TV. • Reset: Restore all TV settings, excluding network settings, to the factory defaults. (Not available)
	<p>Self Diagnosis for HTV</p> <p>Lets you check the state of Pro:Idiom and its communication with the SI STB or SBB. If you have any problems with the Pro:idiom encryption channel or the communications with the SI STB or SBB, use this diagnosis function. If PI DTV Channel Key Loss (Pro:Idiom DTV Channel Key Loss) appears to have failed and the Pro:Idim encryption channel has failed to play content, first check the broadcasting systems related to Pro:Idiom encryption. If your broadcasting system does not have a problem, contact Samsung Service. If STB SI Vendor Setting appears to have failed and communication with the SI STB or SBB has failed, first check your SI STB or SBB. If your SI STB or SBB does not have a problem, contact to Samsung Service.</p>
	<p>Software Update</p> <p>Lets you upgrade the TV Software with a USB flash dirve.</p>
	<p>Sound Bar Out</p> <p>If the Samsung Sound Bar device is connected to this TV, this item lets you to select where the TV sound is outputted when the TV is turned on.</p> <ul style="list-style-type: none"> • ON: When the TV is turned on, the TV sound is automatically outputted in the Sound Bar device only. • OFF: When the TV is turned on, the TV sound is automatically outputted in the TV speaker device.
	<p>Contact Samsung</p> <p>Display the web site of related Samsung service centre, software version, and Mac address information.</p>
	<p>Standby LED</p> <p>When the TV is in standby mode, you can configure the settings of the power indicator.</p> <ul style="list-style-type: none"> • ON: The LED is on. • OFF: The LED is off.
	<p>Boot Logo</p> <p>To enable or disable displaying the Samsung logo when the TV turns on.</p>
	<p>TV Reset</p> <p>Returns all settings on the TV to their factory defaults.</p>

Hotel Option menu Item		Description
Home menu	Home Menu Display	<p>Activate Home Menu in Standalone mode for user.</p> <ul style="list-style-type: none"> • ON: Home Menu enabled. • OFF: Home Menu disabled. <p>In Standalone mode, you can quickly access to various features such as Source, Media Play etc and settings such as Picture Size, Language, etc.</p>
	Home Menu Editor	Edit and manage TV functions to be used from Home Menu.
	Home Menu Auto Start	<p>This option allows you to set Home Menu as first screen for user.</p> <ul style="list-style-type: none"> • ON: Home Menu is shown as first screen. • OFF: Do not show Home Menu as first screen.
REACH Solution	REACH RF Mode	Turn on or off the REACH RF Mode . When set to on, the TV can operate with the REACH Server (Modulator) through the RF cable.
	REACH IP Mode	You can turn on or off the REACH IP Mode . When set to on, the TV can operate with the REACH IP Server through the IP network.
	Server URL Setting	You can enter the address of REACH IP Server. (Example: http://192.168.1.2:443)
	REACH Channel	This is a DTV cable channel PTC number for receiving REACH data when the REACH RF Mode set to on. The value must be same as the value set on the REACH Server (Modulator).
	Group ID	You can set the TV's group ID to manage TVs in groups on the REACH Server (Modulator).
	REACH Update Time	<p>You can set the specific time to receive and update REACH data from the REACH Server (Modulator). (Operates when the AC power cord is plugged in and the power is off.)</p> <ul style="list-style-type: none"> • OFF: You can turn off the REACH Update Time function. • 12:00 am: 12:00 am everyday • 2:00 am: 2:00 am everyday • 12:00 pm: 12:00 pm everyday • 2:00 pm: 2:00 pm everyday
	REACH Update Immediate	When set to on, the TV will receive and update REACH data from the REACH Server (Modulator) right after the power is off. (Operates when the AC power cord is plugged in and the power is off.)
REACH Config Version	Displays the TV configuration data version received from the REACH Server.	

Hotel Option menu Item		Description
H.Browser Solution	H.Browser Mode	You can turn on or off the H.Browser Mode and run the H.Browser Web App .
	H.Browse Vendor	You can select the H.Browse Vendor .
	URL Launcher Setting	<p>H.Browser Solution settings menu</p> <ul style="list-style-type: none"> • Install Web App: Enter the H.Browser server URL where Web App and sssp_config.xml files are located. • Uninstall: You can delete the installed Web App. • Timeout setting: Set the timeout period for connecting to the URL. • Developer Mode: If you used Tizen Studio (SDK) for development, you can connect to the Host PC (which SDK is installed) to use the development tool.
HMS	HMS Mode	You can turn on or off the HMS Mode . When set to on, the TV can operate with the HMS server through the IP network.
	HMS Server URL Setting	You can enter the HMS server's address. (Example: http://192.168.1.2:8080)
	HMS Gateway Role	When there is one TV per room, set to Master . When there are more than one TVs per room, set the main TV to Master and the others to Slave .
	HMS HalfTicker Display	Set to on if you want to use the HalfTicker UI. When set to off, the HalfTicker UI will not be displayed. However, all the hot keys (except for room control key) on the HMS remote control will work normally without the HalfTicker UI Display .
Virtual Standby	Virtual Standby Mode	When the AC power cord is plugged in and the power is off, this option maintains the TV's important features even after the screen is off. <ul style="list-style-type: none"> • Electricity consumption may vary depending on the environment.
	Reboot Time	After the TV power is off (in Virtual Standby Mode) if there is no input from the user within the set Reboot Time , the TV will reboot and enter Virtual Standby Mode again.
Room Number		You can set the room number of the TV's location.

- Refer to the manual of each solution for details about functions and settings of the solutions such as REACH, HMS, and H.Browser.
- REACH (Remote Enhanced Active Control for Hospitality) is a professional, interactive remote controller that lets you deliver TV firmware updates, cloning data, channel mapping changes, REACH contents, and TICKER contents through RF cable to several hundred hospitality TVs simultaneously. The REACH functions are available only in **Standalone** mode. The REACH Server is sold separately. Refer to the REACH Server manual enclosed with the REACH Server product for more operating information.

Welcome Message

Hotel Option (MUTE > 1 > 1 > 9 > Select ) > Logo/Message > Welcome Message

Welcome Message function displays a custom message on the TV every time it is turned on.

- Set **Welcome Message** to on to display the message when the TV is powered on.
- You can make the welcome message and edit it.
- You can edit the welcome message by using on screen keyboard in the **Edit Welcome Message** (Hotel Option > Logo/Message > Edit Welcome Message).
- Use the directional buttons on the remote control to enter the title and message, and select **Save**.

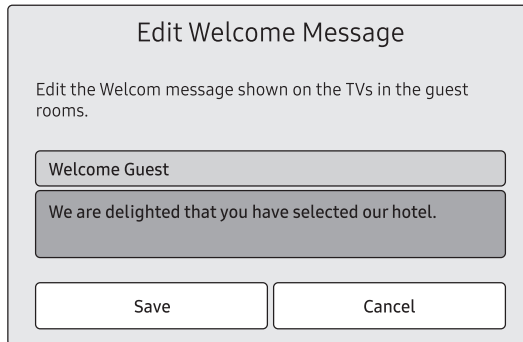

Edit Welcome Message

Edit the Welcom message shown on the TVs in the guest rooms.

Welcome Guest

We are delighted that you have selected our hotel.

Save Cancel

Hotel Logo

Hospitality Logo

Hotel Option (MUTE > 1 > 1 > 9 > Select ) > Logo/Message > Hospitality Logo

Hospitality Logo function displays the Hotel's picture image when the TV is powered on.

- When you set **Hospitality Logo** to AVI / BMP / BOTH, **Hospitality Logo DL** and **Logo Display Time** are enabled.
- If there is a logo image stored in memory and the **Hospitality Logo** is AVI / BMP / BOTH, the logo image is displayed when the TV is turned on.
- The logo image is not displayed when set **Hospitality Logo** to off, even if the logo image has been loaded into the TV.

Logo Download

Hotel Option (MUTE > 1 > 1 > 9 > Select ) > Logo/Message > Hospitality Logo DL

This option lets you download the logo image to the TV's memory from a USB device.

- The wait message appears while the image is being copied to the TV.
- The completed message appears when the copy operation finishes successfully.
- The failed message appears if the copy operation was unsuccessful.
- No USB appears if no USB device is connected.
- If there is no file to copy on the USB device or the file is in the wrong format, the message that there is no file appears.
- If message that there is no file appears and there is a logo file on the USB device, check the file format.
- Logo file format
 - TV Supports all file formats.
 - File name must be "samsung_image.*" and "samsung_video.*"
 - Maximum file size can be 50MB for Smart models.
 - The TV does not change the size or scale of the image.

USB Cloning



Hotel Option (MUTE > 1 > 1 > 9 > Select ) > Cloning

The USB cloning function lets you download user-configured settings (Picture, Sound, Channel, and Hotel Option) from one TV to a USB device, and then upload these settings from the USB device to other TV sets. This lets you create a standard file of settings and distribute that standard file to all the TVs in your facility.

- After cloning, certain features are applied when the TV is turned on again.

Cloning TV to USB: Copies stored menu settings from a TV to a USB device

Hotel Option (MUTE > 1 > 1 > 9 > Select ) > Cloning > Clone TV to USB

1. Insert a USB device into the USB port on the rear of the TV.
2. Enter the **Hotel Option** menu by pressing buttons in order. (MUTE > 1 > 1 > 9 > Select )
3. Press the up or down directional button to select **Clone TV to USB**, and press the **Select**  button on the remote control.
4. The cloning message is displayed.
 - The clone folder will be labelled T-KTM2DEUCB.
 - The cloned values include the values on the guest side menu (Brightness, Picture Size, Contrast, etc.) and the **Hotel Option** menu.

Cloning USB to TV: Copies menu settings and channel data in a USB device to a TV

Shortcut: Turn the TV off, insert the USB device, turn the TV on, and then press the **Select** button on the remote control for 5 seconds.

To clone data to the TV using the Hotel menu, follow these steps:

1. Turn the TV off.
2. Insert the USB device into the USB port on the rear of the TV.
3. Turn the TV on.
4. Enter the **Hotel Option** menu by pressing buttons in order. (**MUTE** > **1** > **1** > **9** > **Select** button)
5. Press the up or down directional button to select **Clone USB to TV**, and press the **Select** button on the remote control.
6. The message **Clone settings from USB to TV** is displayed. Press the **Select** button on the remote control.
 - If there is no file to copy on the USB device or the message that there is no file appears, check the folder on your USB device.
 - The folder name should be **T-KTM2DEUCB**.
 - Tables that list the settings that are cloned in the **Hotel Option** menu begin on the next page.

Pre-condition for cloning (check point)

- Cloning should be done between same model (same SW version).
- Before cloning, all displays should be updated at the latest version (same SW version).

Settings Cloned in the Hotel Menu

- The menu items may not be supported depending on the models.

Menu Item	Sub Item	Cloned or not	
Hospitality Mode	Standalone / Interactive	Yes	
SI Vendor	Interactive mode : Samsung / 2M / Locatel / VDA / VDA-S / Acentic / Sustinere / Quadriga / ETV / IBahn / Magilink / Otrum / Siemens / Amino / MDC / Enseio Standalone mode : OFF / Movielink / Swisscom / Smoovie / SSCP	Yes	
Power On	Power On Channel	User Defined / Last Saved	Yes
	Power On Channel Num	***	Yes
	Power On Channel Type	ATV / DTV / CATV / CDTV / SDTV	Yes
	Power On Volume	User Defined / Last Saved	Yes
	Power On Volume Num	0~100	Yes
	Min Volume	0~100	Yes
	Max Volume	0~100	Yes
	Power On Source	TV / HDMI1 / HDMI2 / HDMI3 / AV / COMP / Last Saved	Yes
Power On Option	Power On / Standby / Last Option	Yes	
Channel	Channel Setup	—	No
	Channel Editor	—	No
	Channel Bank Editor	—	No
	Mixed Channel Map	ON / OFF	Yes
	Dynamic SI	ON / OFF	Yes
	Channel Rescan Message	ON / OFF	Yes
	Pan Euro MHEG	ON / OFF	Yes
	MyChannel	ON / OFF	Yes
	Subtitle Auto On	ON / OFF	Yes
TTX Widescreen Mode	ON / OFF	Yes	
Menu OSD	Picture Menu Lock	ON / OFF	Yes
	Menu Display	ON / OFF	Yes
	Channel Menu Display	ON / OFF	Yes
	Panel Button Lock	Unlock / Lock / OnlyPower	Yes
Clock	Local Time	Standalone: Manual / TTX / Time Channel Interactive: Manual / Auto / TTX / Time Channel	Yes
	Timer Type	WakeUp / OnOff	Yes
	Time Channel Type	DTV / CDTV / SDTV	Yes
	Time Channel Num	***	
	NTP Settings	***	No
Music Mode	Music Mode AV	ON / OFF	Yes
	Music Mode Comp.	ON / OFF	Yes
	Music Mode Backlight	ON / OFF	Yes

Menu Item		Sub Item	Cloned or not
Remote Jack Pack	Priority AV	1~2	Yes
	Priority HDMI	1~2	Yes
	HDMI Option	HDMI1 / HDMI2 / HDMI3	Yes
	HDMI Music Mode	ON / OFF	Yes
External Source	USB Pop-up Screen	Default / Automatic / Disable	Yes
	External Source Banner	ON / OFF	Yes
	Auto Source	ON / OFF	Yes
	Anynet+Return Source	Power On Src / Last Source / Each model source list (TV, HDMI1, HDMI2, etc.)	Yes
Bathroom Speaker	SubAmp Mode	0~2	Yes
	SubAmp Volume	0~32	Yes
Eco Solution	Power Saving Mode	OFF / Low / Medium / High	Yes
	Power Saving Mode Timer	0~99	Yes
Logo / Message	Welcome Message	ON / OFF	Yes
	Edit Welcome Message	—	Yes
	Hospitality Logo	OFF / BMP / AVI / BOTH	Yes
	Hospitality Logo DL	—	Yes
	Logo Display Time	3 second / 5 second / 7 second	Yes
Cloning	Clone TV to USB	—	No
	Clone USB to TV	—	No
	Setting Auto Intialize	ON / OFF	Yes
Network	Network Setup	—	No
	Apps ID Setting	—	Yes
	Apps Setting	—	No
	Service Discovery	ON / OFF	Yes
	LAN OUT	ON / OFF	Yes
	VLAN ID	ON / OFF	Yes
	Solution VLAN ID	1~4094	Yes
	Device LAN ID	1~4094	Yes
ARP Interval	2s / 5s / 10s / 30s / 60s / 120s / 180s	Yes	
System Manager	—	No	
SI Config	TV Version	1.0 / 2.0	Yes
Security	FactoryLock	ON / OFF	Yes
	Password Popup	ON / OFF	Yes
	Password Input	—	No
	Password Setting	—	Yes
	Password Reset	—	No
	Security Mode	ON / OFF	Yes
	USB	Enable / Disable	Yes
	HDMI	Enable / Disable	Yes
	TTX Security	Enable / Disable	Yes

Menu Item		Sub Item	Cloned or not
DRM	DRM Mode	OFF / LYNKDRM	Yes
System	Self Diagnosis for TV	—	No
	Self Diagnosis for HTV	STB SI Vendor Setting	Si Name Sucess / Failure
		Bathroom AMP	Sucess / Failure
		RTC	Sucess / Failure
	Software Update	—	No
	Sound Bar Out	ON / OFF	Yes
	Contact Samsung	—	No
	Standby LED	ON / OFF	Yes
Boot Logo	ON / OFF	Yes	
TV Reset	—	No	
Home Menu	Home Menu Display	ON / OFF	Yes
	Home Menu Editor	—	Yes
	Home Menu Auto Start	ON / OFF	Yes
REACH Solution	REACH RF Mode	ON / OFF	Yes
	REACH IP Mode	ON / OFF	Yes
	Server URL Setting	—	Yes
	REACH Channel	***	Yes
	Group ID	ALL, 1 - 511	No
	REACH Update Time	OFF / 12:00 am / 2:00 am / 12:00 pm / 2:00 pm	Yes
	REACH Update Immediate	ON / OFF	Yes
REACH Config Version	—	No	
H.Browser Solution	H.Browser Mode	ON / OFF	Yes
	H.Browser Vendor	Others / Sonifi	Yes
	URL Launcher Setting	—	Yes
HMS	HMS Mode	ON / OFF	Yes
	HMS Server URL Setting	—	Yes
	HMS Gateway Role	Master / Slave	Yes
	HMS HalfTicker Display	ON / OFF	Yes
Virtual Standby	Virtual Standby Mode	ON / OFF	Yes
	Reboot Time	OFF / 5 / 15 / 30 / 60	
Room Number		—	No

Setting Auto Initialise

Hotel Option (MUTE > 1 > 1 > 9 > Select ) > Cloning > Setting Auto Initialize

When you clone settings from one TV to another, you clone both the guest side menu and hotel side menu settings: **Picture, Sound, Channel, and Hotel Option** menu. This lets you set nearly all of the menu values on your hospitality TVs to the same, standard settings. If you allow guests access to the guest side menus, for example the **Picture** menu, they can change the settings in those menus so they are no longer standard. If you set the **Setting Auto Initialize** function to on the TV automatically restores (initialises) any guest-side menu values to the cloned, standard values when the TV is turned off and then turned on again. Note that **Setting Auto Initialize** works on cloned guest side menu values only. Settings which have not been cloned are ignored.

The table below lists the settings that are restored to their cloned values when you set the **Setting Auto Initialize** function to on.

- The menu items may not be supported depending on the models.

Menu Item				
Picture	Picture Mode			
	Picture Size Settings	Picture Size		
		Fit to screen		
		Zoom and Position		
	Expert Settings	Backlight		
		Brightness		
		Contrast		
		Sharpness		
		Colour		
		Tint (G/R)		
		Apply Picture Settings		
		Digital Clean View		
		Auto Motion Plus Settings	Auto Motion Plus	
			Judder Reduction	
			LED Clear Motion	
	Contrast Enhancer			
	Film Mode			
Colour Tone				

Menu Item				
Picture	Expert Settings	White Balance	2 Point	R-Gain
				G-Gain
				B-Gain
				R-Offset
				G-Offset
				B-Offset
			20 Point Settings	20 Point
				Interval
				Red
				Green
		Colour Space Settings	Blue	
			Gamma	
			RGB Only Mode	
			Colour Space	
			Colour	
Sound	Expert Settings			Red
				Green
				Blue
				Sound Output
				Sound Mode
				Balance
				Equaliser
				HDMI Input Audio Format
				Digital Output Audio Format
				Audio Delay
Auto Volume				
Sound Feedback				

Menu Item			
Broadcasting	Auto Tuning		
	Aerial		
	Programme Rating Lock		
	Common Interface	CI Menu	
		Application Info	
		Descramble Mode	
Dual Sound			
Expert Settings	Audio Options		
General	Network	Network Status	
		Soft AP	Soft AP
			Security Key
			Security Key Reset
			Wi-Fi
		Open Network Settings	
		Reset Network	
		WPA Certificate Manager	
	Expert Settings	IPv6	
		IPv6 Status	
	System Manager	Time	Clock
			Sleep Timer
			Alarm
		Language	
		Device Name	
		Change PIN	
Auto Protection Time			
Smart Security		Scan	
	Isolated List		

Menu Item			
General	External Device Manager	Anynet+ (HDMI-CEC)	
		Game Mode	
		HDMI UHD Color	
		HDMI Black Level	
		Input Device Manager	Bluetooth Device List
			Keyboard Language
			Keyboard type
		Device Connection Manager	Access Notification
	Device List		
	Eco Solution	Ambient Light Detection	
		Minimum Backlight	
		Energy Saving Mode	
		Motion Lighting	
		Auto Power Off	
	Accessibility	Voice Guide Settings	Voice Guide
			Volume
			Speed
			Pitch
		Audio Description Settings	Audio Description
			Audio Description Volume
			High Contrast
			Greyscale
			Colour Inversion
Enlarge			
Subtitle Settings			Subtitle
			Subtitle Mode
			Subtitle Language
			Primary Subtitle Language
			Secondary Subtitle Language
	Multi-output Audio		



Updating the TV's Software

DO NOT turn off the TV's power until the update is complete. The TV will turn off and on automatically after completing the software update. Video and audio settings will be reset to their defaults after a software update. We recommend you clone the TV's settings so that you can easily reset them after the upgrade.

- For more information about the USB cloning function, refer to page 44.

Updating through a USB device

To update the TV's software, follow these steps:

1. Insert a USB flash drive containing the software update file into the USB port of the TV.
 2. Run **Update Now**. (MENU  > Support > Software Update > Update Now)
 3. The TV displays a pop-up message that checks for the updated version.
 4. Move the focus to **OK**, and then press the **Select**  button on the remote control.
- Please be careful to not disconnect the power or remove the USB flash drive while upgrades are being applied. The TV will turn off and turn on automatically after completing the SW upgrade. Please check the SW version after the upgrades are complete.

09 Using a Multi Code Remocon

A Multi Code Remocon is a special remote which is designed to control multiple TVs. This function is useful where there is more than one TV in a location.

You can control up to 10 TVs with a different ID code of each remote with no conflicts between the TVs. ID numbers are displayed on each TV's OSD.

The Initial ID code for each TV is **0**.

- You can set and reset the ID code in analogue TV mode or PC mode. (Not available in DTV mode.)
- You can set the ID code to any digit from **0** to **9**.
- To set a TV's ID code, follow these steps:
 1. Aim the remote at the TV, and then press the **MUTE** button and the **RETURN** button simultaneously for more than 7 seconds. When you stop pressing the buttons, the TV displays the current ID in the middle of the screen and a message appears.
 2. Press the number on the remote you want to assign to the TV. The TV displays a message.
 3. After you see the message, if you press **1**, the TV and Remote will be set to ID code **1**.
 - The TV can then only be controlled by a remote which has the same ID code **1**.
 - To reset the ID code, press the **MUTE** button and the **EXIT** button simultaneously for more than 7 seconds. When you stop pressing the buttons, the ID codes of the TV and Remote are reset to **0**.

10 Setting the Soundbar

Samsung Soundbar and Hospitality TV

- Samsung Soundbar and hospitality TVs support the HDMI ARC feature. If you connect a compatible Samsung Soundbar to a compatible Samsung hospitality TV using a single HDMI cable, guests can listen to the TV's sound through the Soundbar.
- **Sound bar Out** in **Hotel Option** menu makes you control to where the TV sound is outputted when the TV is turned on.
 - **Hotel Option (MUTE > 1 > 1 > 9 > Select [⏏]) > System > Sound Bar Out**
- If **Sound bar Out** set to on, the TV sound is automatically outputted in the Soundbar device only whenever TV is turned on.
- If **Sound bar Out** set to off, the TV sound is automatically outputted in the TV speaker only whenever TV is turned on.
- Models supporting the ARC function are listed below:
 - HW-Q60T
 - HW-Q60T/ZA

Setting the Soundbar to Hotel Mode

1. Set the following options in **Hotel Option (MUTE > 1 > 1 > 9 > Select [⏏])**:
 - **System > Sound Bar Out > ON**
 - **Power On > Power On Volume > User Defined**
 - **Power On > Power On Volume Num > set greater than 0**
 - **Power On > Max Volume > set greater than 0**
2. Connect an HDMI cable from the HDMI out port of the Soundbar to the HDMI port (supporting ARC) on the TV.
3. After the Soundbar is connected to the TV, when the TV turns on, the Soundbar automatically detects the TV, and then automatically switches to Hotel Mode.

Soundbar features in Hotel mode



- Power on / off is synchronised with the TV.
- HDMI-CEC defaults set to on
- Available only through the HDMI out port.
- Disables the "Input mode" key on the VFD to prevent unexpected audio-source changes.
- Acquires adjustable **Power On** and **Max Volume** settings from the TV's **Hotel Option** menu. However Soundbar's **Power On Volume** and **Max Volume** values are set to half of **Power On Volume** and **Max Volume** settings in the TV's **Hotel Option** menu.
 - If the TV's **Power On Volume** = 20 and **Max Volume** = 90, then Soundbar's **Power On Volume** = 10 and **Max Volume** = 45.
- To use **Voice Guide** while an external device is connected to the **DIGITAL AUDIO OUT (OPTICAL)** or **HDMI IN (ARC)** terminal, be sure to select **PCM** at **MENU [⏏] > Sound > Expert Settings > Digital Output Audio Format**.

11 Editing Channels

Channel Bank Editor (Smovie TV Only)

Channel Bank Editor in conjunction with the SMOOVIE remote lets you control the channels guests have access to. Channel Bank Editor provides three Banks of channels and lets you select which channels will be available from each bank. SMOOVIE remotes have installable Bank Cards which correspond to the channel banks in the Channel Bank Editor. The remotes only allow access to channels in the channel bank that correspond to the installed card. Consequently, the channels a guest can access depend on the Bank Card installed in their SMOOVIE remote.

Setting the Channel Bank Editor under Standalone Mode

1. Press MUTE > 1 > 1 > 9 > Select  buttons on the remote control to enter the Hotel Option menu.
2. Go to SI vendor, and then select Smovie.
3. Go to Channel > Channel Bank Editor. Press the Select  button on the remote control.
4. Enter the Channel Bank Editor. Edit the Channel Bank.
 - Bank1 (Free channel): Select the channels that will be accessible when a remote doesn't have a card.
 - Bank2 (Family Card - Green): Select the channels that will be accessible when a remote has a GREEN CARD.
 - Bank3 (Adult Card - Red): Select the channels that will be accessible when a remote has a RED CARD.

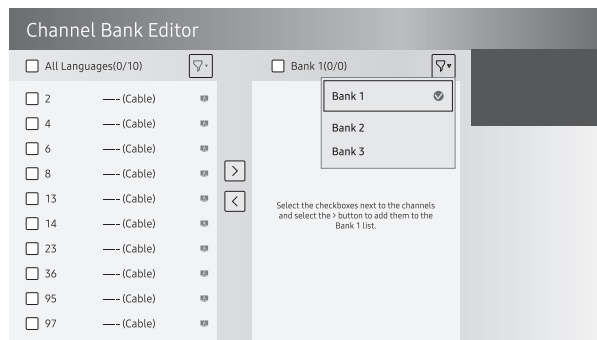

Information About SMOOVIE Remote Controls

- If you select SMOOVIE as the SI vendor, you should also use SMOOVIE remotes in your facility.
- Guests with remotes that do not have a card can only view channels from Bank 1.
- Guests using the numeric button on the remote control to change channels can only view channels from Bank 1.
- Guests with remotes that have Green or Red cards must use the channel up or down directional buttons to change channels.
- Guests can only see channels from the Bank 1 channel list in the Guide or the Channel List.

Smooovie Set Up Sequence

1. Complete the Initial Setup.
2. The TV displays the **Hotel Option** menu.
 - If the Initial Setup is already done, enter the **Hotel Option** menu. (MUTE > 1 > 1 > 9 > Select [EXIT])
3. Select the channel type. (Power On > Power On Channel Type)
 - ATV or DTV for Aerial
 - CATV or CDTV for cable
4. Select **Smooovie** in the **SI Vendor** menu.
5. Select **Channel Setup** (Channel > Channel Setup).
6. Select **Terrestrial** or **Cable** to auto tune.
7. Set up channels in the **Channel Bank Editor** (Channel > Channel Bank Editor).
8. Turn off the TV, and then turn it on again. Then guests can use the TV.

Using Channel Editor

Hotel Option (MUTE > 1 > 1 > 9 > Select [EXIT]) > **Channel** > **Channel Editor**

Using **Channel Editor** you can edit the channels stored in the TV's memory.

- Change the channel numbers and names, edit the channel language and channel genre and delete channels.
 - This function is enabled when **My Channel** set to **On** in **Hotel Option** menu. (**Hotel Option** (MUTE > 1 > 1 > 9 > Select [EXIT]) > **Channel** > **My Channel**)
- Apply the **Screen Off** to channels you select. The **Screen Off** blanks out the video from a channel and outputs only the sound while displaying a screen off icon on the screen.
- **Channel Editor** also lets you view information about each channel easily, without your having to display each channel directly.

General Steps for Using the Channel Editor in Standalone Mode

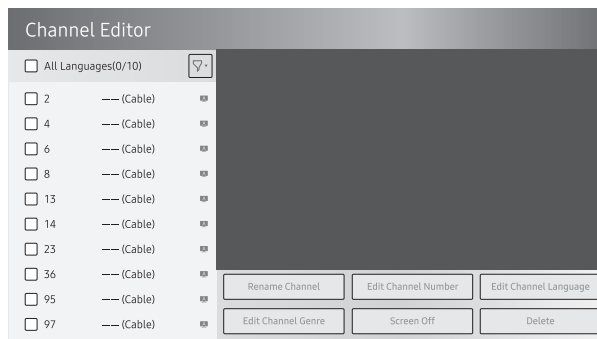

1. Run **Channel Setup** (Channel > Channel Setup) in the **Hotel Option** menu.
2. Enter **Channel Editor** (Channel > Channel Editor) in the **Hotel Option** menu.
3. On a piece of paper, compile a list of channels you want to have, arranged in the order you want.
4. Based on the list created in Step 3, rearrange the channels and edit the channel names.
5. Press the **EXIT** or **RETURN** button to exit.

Editing the Channel Number

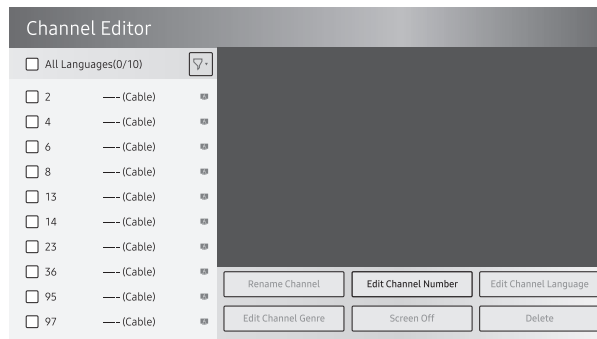

Change the channel number of a channel you select. To change a channel number, follow these steps:

1. Select a channel on the **Channel Edit** screen.
2. Use the directional buttons on the remote control, move the focus to **Edit Channel Number**, and **Select** button.
3. Use the up or down directional buttons on the remote control to change the channel number.
4. Select **OK** when done, and then press the **Select** button on the remote control.
 - When you change the channel number, the channel information is updated automatically.

Rename the Channel

Change the name of a channel you select. To change the name of a channel, follow these steps:

1. Select a channel on the **Channel Edit** screen.
2. Use the directional buttons on the remote control, move the focus to **Rename channel**, and **Select** button.
3. Use the on-screen keyboard that appears to enter the new name for the channel. Use the directional buttons on the remote control, select a letter or number, and then press **Select** button. Repeat for each letter or number you want to select.
4. When finished, select **Done** on the bottom of the screen, and then press the **Select** button on the remote control.

Assigning the Channel Number to the external device

The external device source of the TV are displayed in the last page of the **Channel Editor** menu as shown below.

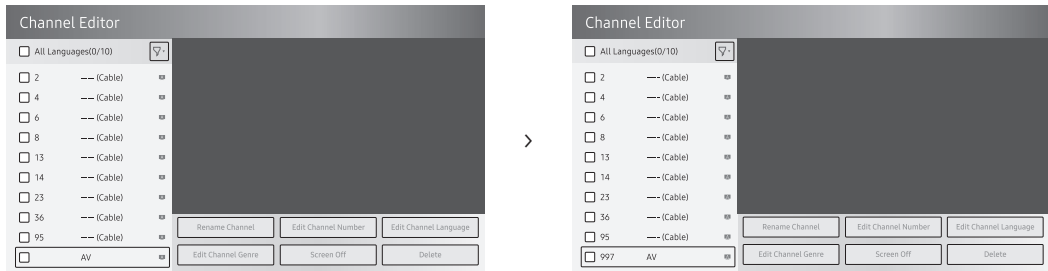

1. Select a external device source on the **Channel Edit** screen.
 2. Use the directional buttons on the remote control, move the focus to **Edit Channel Number**, and **Select** button.
 3. Use the up or down directional buttons on the remote control to assign the channel number.
 4. Select **OK** when done, and then press the **Select** button on the remote control.
- Once you assign a channel number to an external device, you can enter the external device without opening the TV source menu.

12 Anti-theft Kensington Lock

The Kensington Lock is a device you can use to physically fix a TV to a location when you use it in a public place. The appearance and locking method may differ from the illustration at right, depending on the manufacturer. Refer to the manual provided with the Kensington Lock for additional information on proper use.

- The Kensington Lock slot is only available on the HG43ET690U model.

The Kensington Lock is not supplied by Samsung.

- Please find the  icon on the rear of the TV. A Kensington slot is beside the  icon.

To lock the product, follow these steps:

1. Wrap the Kensington lock cable around a large, stationary object such as desk or chair.
 2. Slide the end of the cable with the lock attached through the looped end of the Kensington lock cable.
 3. Insert the locking device into the Kensington slot on the product **1**.
 4. Lock the lock.
- These are general instructions. For exact instructions, see the User manual supplied with the locking device.
 - The locking device has to be purchased separately.
 - The location of the Kensington slot may be different depending on the TV model.

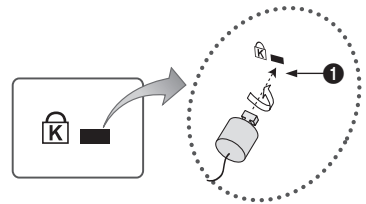

13 Specifications and Other Information

Specifications

Model Name	HG43ET690U	HG50ET690U
Display Resolution	3840 x 2160	3840 x 2160
Screen Size Measured Diagonally	43 inches 108 cm	50 inches 125 cm
Sound (Output)	20 W	20 W
Stand Swivel (Left / Right)	20° / 60° / 90°	20° / 60° / 90°
Dimensions (W x H x D) Body With stand	963.9 x 558.9 x 59.6 mm 963.9 x 610.9 x 226.5 mm	1116.8 x 644.2 x 59.9 mm 1116.8 x 696.8 x 226.5 mm
Weight Without Stand With Stand	8.6 kg 11.8 kg	11.9 kg 15.1 kg
Model Name	HG55ET690U	HG65ET690U
Display Resolution	3840 x 2160	3840 x 2160
Screen Size Measured Diagonally	55 inches 138 cm	65 inches 163 cm
Sound (Output)	20 W	20 W
Stand Swivel (Left / Right)	20° / 60° / 90°	0°
Dimensions (W x H x D) Body With stand	1230.5 x 707.2 x 59.9 mm 1230.5 x 759.8 x 226.5 mm	1449.4 x 830.3 x 59.9 mm 1449.4 x 906.6 x 282.1 mm
Weight Without Stand With Stand	14.3 kg 17.5 kg	21.1 kg 21.4 kg
Model Name	HG75ET690U	
Display Resolution	3840 x 2160	
Screen Size Measured Diagonally	75 inches 189 cm	
Sound (Output)	20 W	
Stand Swivel (Left / Right)	0°	
Dimensions (W x H x D) Body With stand	1673.2 x 958.2 x 59.9 mm 1673.2 x 1047.9 x 341.1 mm	
Weight Without Stand With Stand	30.9 kg 31.3 kg	

Environmental Considerations

Operating Temperature	10°C to 40°C (50°F to 104°F)
Operating Humidity	10% to 80%, non-condensing
Storage Temperature	-20°C to 45°C (-4°F to 113°F)
Storage Humidity	5% to 95%, non-condensing

Notes

- The design and specifications are subject to change without prior notice.
- For information about the power supply, and more information about power consumption, refer to the label-rating attached to the product.
- You can see the label-rating attached to the back of the TV. (For some models, you can see the label-rating inside the cover terminal.)
- Typical power consumption is measured according to IEC 62087.

Decreasing power consumption

When you shut the TV off, it enters Standby mode. In Standby mode, it continues to draw a small amount of power. To decrease power consumption, unplug the power cord when you don't intend to use the TV for a long time.

Supported Resolutions for UHD Input Signals

- Resolution: 3840 x 2160p, 4096 x 2160p
 - An HDMI connection with HDMI UHD Color set to Off supports up to UHD 50P/60P 4:2:0 input signals, while an HDMI connection with HDMI UHD Color set to On supports up to UHD 50P/60P 4:4:4 and 4:2:2 input signals.
 - MENU > General > External Device Manager > HDMI UHD Color

If HDMI UHD Color is set to Off

Frame rate (fps)	RGB	YCbCr 4:4:4	YCbCr 4:2:2	YCbCr 4:2:0
24 / 25 / 30	0	0	0	-
50 / 60	-	-	-	0

If HDMI UHD Color is set to On

Frame rate (fps)	RGB	YCbCr 4:4:4	YCbCr 4:2:2	YCbCr 4:2:0
24 / 25 / 30	0	0	0	-
50 / 60	0	0	0	0

Display Resolution

When you use your TV as a computer monitor, you can also select one of the standard resolutions listed in the Resolution column. The TV will automatically adjust to the resolution you choose.

Mode	Resolution	Display format	Horizontal frequency (KHz)	Vertical frequency (Hz)	Clock frequency (MHz)	Polarity (horizontal / vertical)
IBM	720 x 400	70 Hz	31.469	70.087	28.322	-/+
MAC	640 x 480	67 Hz	35.000	66.667	30.240	-/-
	832 x 624	75 Hz	49.726	74.551	57.284	-/-
	1152 x 870	75 Hz	68.681	75.062	100.000	-/-
VESA DMT	640 x 480	60 Hz	31.469	59.940	25.175	-/-
	640 x 480	72 Hz	37.861	72.809	31.500	-/-
	640 x 480	75 Hz	37.500	75.000	31.500	-/-
	800 x 600	60 Hz	37.879	60.317	40.000	+/+
	800 x 600	72 Hz	48.077	72.188	50.000	+/+
	800 x 600	75 Hz	46.875	75.000	49.500	+/+
	1024 x 768	60 Hz	48.363	60.004	65.000	-/-
	1024 x 768	70 Hz	56.476	70.069	75.000	-/-
	1024 x 768	75 Hz	60.023	75.029	78.750	+/+
	1152 x 864	75 Hz	67.500	75.000	108.000	+/+
	1280 x 720	60 Hz	45.000	60.000	74.250	+/+
	1280 x 800	60 Hz	49.702	59.810	83.500	-/+
	1280 x 1024	60 Hz	63.981	60.020	108.000	+/+
	1280 x 1024	75 Hz	79.976	75.025	135.000	+/+
	1366 x 768	60 Hz	47.712	59.790	85.500	+/+
	1440 x 900	60 Hz	55.935	59.887	106.500	-/+
	1600 x 900RB	60 Hz	60.000	60.000	108.000	+/+
	1680 x 1050	60 Hz	65.290	59.954	146.250	-/+
1920 x 1080	60 Hz	67.500	60.000	148.500	+/+	
1920 x 1200	60 Hz	74.556	59.885	193.250	-/+	

Mode	Resolution	Display format	Horizontal frequency (KHz)	Vertical frequency (Hz)	Clock frequency (MHz)	Polarity (horizontal / vertical)
CEA-861	720(1440) x 576i	50 Hz	15.625	50.000	27.000	- / -
	720(1440) x 480i	60 Hz	15.734	59.940	27.000	- / -
	720 x 576	50 Hz	31.250	50.000	27.000	- / -
	720 x 480	60 Hz	31.469	59.940	27.000	- / -
	1280 x 720	50 Hz	37.500	50.000	74.250	+ / +
	1280 x 720	60 Hz	45.000	60.000	74.250	+ / +
	1920 x 1080i	50 Hz	28.125	50.000	74.250	+ / +
	1920 x 1080i	60 Hz	33.750	60.000	74.250	+ / +
	1920 x 1080	24 Hz	27.000	24.000	74.250	+ / +
	1920 x 1080	25 Hz	28.125	25.000	74.250	+ / +
	1920 x 1080	30 Hz	33.750	30.000	74.250	+ / +
	1920 x 1080	50 Hz	56.250	50.000	148.500	+ / +
	1920 x 1080	60 Hz	67.500	60.000	148.500	+ / +
	3840 x 2160	24 Hz	54.000	24.000	297.000	+ / +
	3840 x 2160	25 Hz	56.250	25.000	297.000	+ / +
	3840 x 2160	30 Hz	67.500	30.000	297.000	+ / +
	3840 x 2160	50 Hz	112.500	50.000	594.000	+ / +
	3840 x 2160	60 Hz	135.000	60.000	594.000	+ / +
	4096 x 2160	24 Hz	54.000	24.000	297.000	+ / +
	4096 x 2160	25 Hz	56.250	25.000	297.000	+ / +
4096 x 2160	30 Hz	67.500	30.000	297.000	+ / +	
4096 x 2160	50 Hz	112.500	50.000	594.000	+ / +	
4096 x 2160	60 Hz	135.000	60.000	594.000	+ / +	
HDMI	3840 x 2160	30 Hz	67.500	30.000	297.000	+ / +
	3840 x 2160	25 Hz	56.250	25.000	297.000	+ / +
	3840 x 2160	24 Hz	54.000	24.000	297.000	+ / +
	4096 x 2160	24 Hz	54.000	24.000	297.000	+ / +

- The interlaced mode is not supported.
- The set might operate abnormally if you select a non-standard video format.
- Separate and Composite modes are supported. SOG (Sync On Green) is not supported.

Dimensions

Front view / Side view

The displayed image may differ from your TV, depending on the model.

- 43"

(Unit: mm)

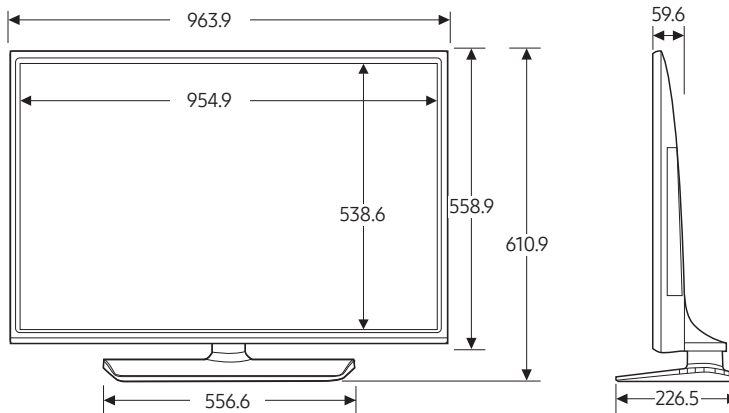

- 50"

(Unit: mm)

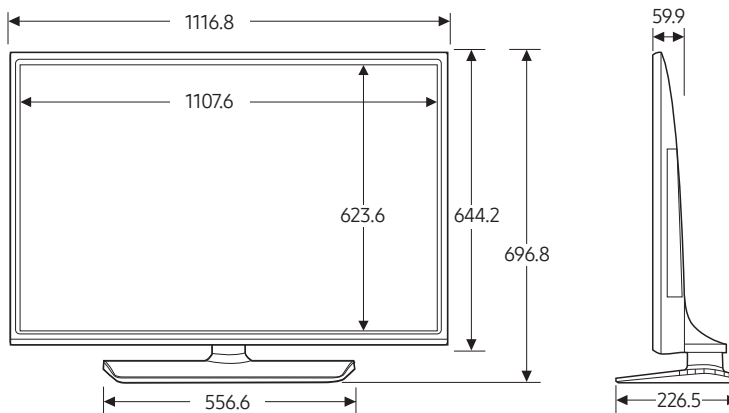

• 55"

(Unit: mm)

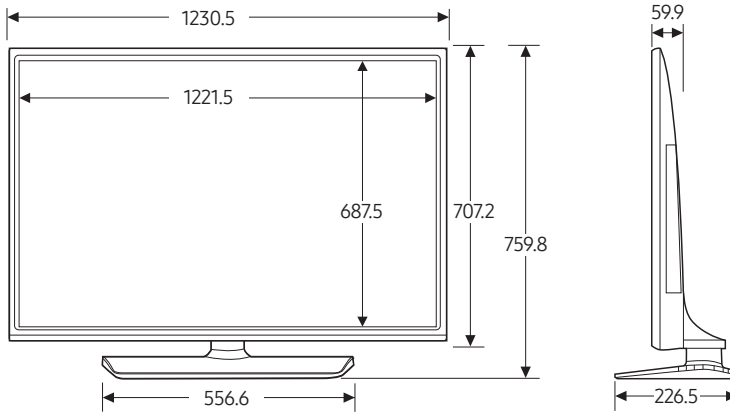

• 65"

(Unit: mm)

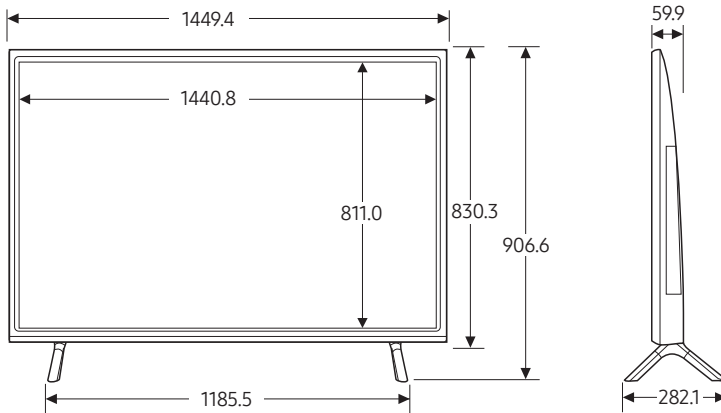

• 75"

(Unit: mm)

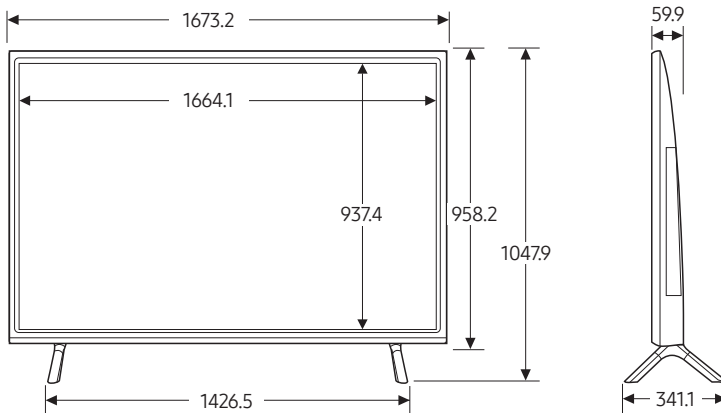

Jack panel detail / Rear view

Detailed dimensions can be checked at Displaysolutions.samsung.com.

Base Stand detail

The displayed image may differ from your TV, depending on the model.

- 43"

(Unit: mm)

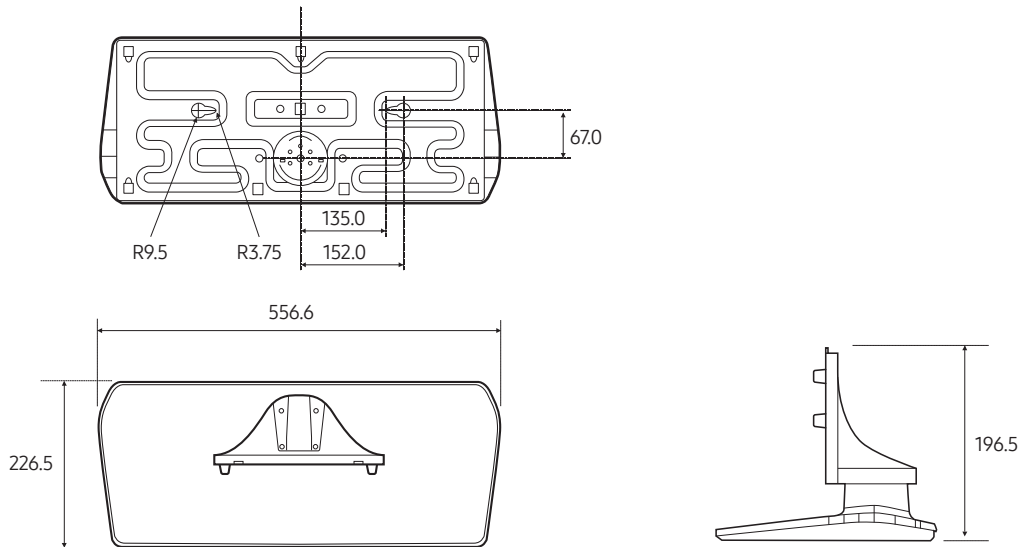

- 50"-55"

(Unit: mm)

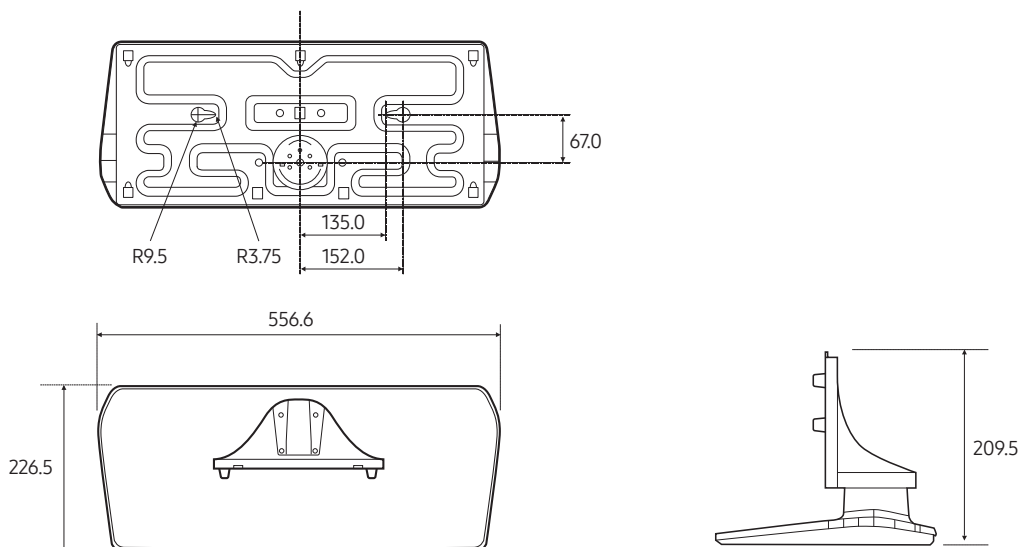

- 65"

(Unit: mm)

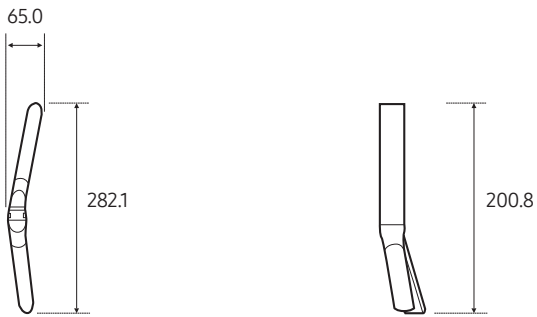

- 75"

(Unit: mm)

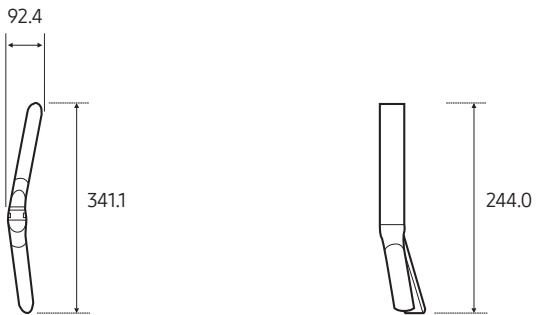

- **NOTE:** All drawings are not necessarily to scale. Some dimensions are subject to change without prior notice. Refer to the dimensions prior to performing installation of your TV. Not responsible for typographical or printed errors.

Licences



Manufactured under license from Dolby Laboratories. Dolby, Dolby Audio, Pro Logic, and the double-D symbol are trademarks of Dolby Laboratories.



THIS PRODUCT IS SOLD WITH A LIMITED LICENCE AND IS AUTHORISED TO BE USED ONLY IN CONNECTION WITH HEVC CONTENT THAT MEETS EACH OF THE THREE FOLLOWING QUALIFICATIONS: (1) HEVC CONTENT ONLY FOR PERSONAL USE; (2) HEVC CONTENT THAT IS NOT OFFERED FOR SALE; AND (3) HEVC CONTENT THAT IS CREATED BY THE OWNER OF THE PRODUCT.

THIS PRODUCT MAY NOT BE USED IN CONNECTION WITH HEVC ENCODED CONTENT CREATED BY A THIRD PARTY, WHICH THE USER HAS ORDERED OR PURCHASED FROM A THIRD PARTY, UNLESS THE USER IS SEPARATELY GRANTED RIGHTS TO USE THE PRODUCT WITH SUCH CONTENT BY A LICENSED SELLER OF THE CONTENT.

YOUR USE OF THIS PRODUCT IN CONNECTION WITH HEVC ENCODED CONTENT IS DEEMED ACCEPTANCE OF THE LIMITED AUTHORITY TO USE AS NOTED ABOVE.



The terms HDMI and HDMI High-Definition Multimedia Interface, and the HDMI Logo are trademarks or registered trademarks of HDMI Licensing LLC in the United States and other countries.

Open Source License Notice

Open Source used in this product can be found on the following webpage. (<http://opensource.samsung.com>)

SAMSUNG

Contact SAMSUNG WORLD WIDE

If you have any questions or comments relating to Samsung products, please contact the Samsung service centre.

Country	Samsung Service Centre ☎	Web Site
AUSTRIA	0800 72 67 864 (0800-SAMSUNG)	www.samsung.com/at/support
BELGIUM	02-201-24-18	www.samsung.com/be/support (Dutch) www.samsung.com/be_fr/support (French)
BOSNIA	055 233 999	www.samsung.com/support
ALBANIA	045 620 202	www.samsung.com/al/support
BULGARIA	*3000 Цена на един градски разговор 0800111 31 Безплатен за всички оператори	www.samsung.com/bg/support
CROATIA	072 726 786	www.samsung.com/hr/support
CZECH	800 - SAMSUNG (800-726786) Samsung Electronics Czech and Slovak, s.r.o. V Parku 2323/14, 148 00 - Praha 4	www.samsung.com/cz/support
DENMARK	707 019 70	www.samsung.com/dk/support
FINLAND	030-6227 515	www.samsung.com/fi/support
FRANCE	01 48 63 00 00	www.samsung.com/fr/support
GERMANY	06196 77 555 77	www.samsung.com/de/support
CYPRUS	8009 4000 only from landline, toll free	www.samsung.com/gr/support
GREECE	80111-SAMSUNG (80111 726 7864) only from land line (+30) 210 6897691 from mobile and land line	
HUNGARY	0680SAMSUNG (0680-726-7864)	www.samsung.com/hu/support
ITALIA	800-SAMSUNG (800.7267864)	www.samsung.com/it/support
LUXEMBURG	261 03 710	www.samsung.com/be_fr/support
MONTENEGRO	020 405 888	www.samsung.com/support
SLOVENIA	080 697 267 (brezplačna številka)	www.samsung.com/si/support
NETHERLANDS	088 90 90 100	www.samsung.com/nl/support
NORWAY	21629099	www.samsung.com/no/support
POLAND	801-172-678* lub +48 22 607-93-33* * (opłata według taryfy operatora)	www.samsung.com/pl/support
PORTUGAL	808 207 267	www.samsung.com/pt/support
ROMANIA	*8000 (apel in retea) 08008-726-78-64 (08008-SAMSUNG) Apel GRATUIT Atenție: Dacă efectuați apelul din rețeaua Digi (RCS/RDS), vă rugăm să ne contactați formând numărul Telverde fără ultimele două cifre, astfel: 0800872678.	www.samsung.com/ro/support
SERBIA	011 321 6899	www.samsung.com/rs/support
KOSOVO	080010101	www.samsung.com/support
SLOVAKIA	0800 - SAMSUNG (0800-726 786)	www.samsung.com/sk/support
SPAIN	91 175 00 15	www.samsung.com/es/support
SWEDEN	0771 726 786	www.samsung.com/se/support
SWITZERLAND	0800 726 786	www.samsung.com/ch/support (German) www.samsung.com/ch_fr/support (French)
UK	0333 000 0333	www.samsung.com/uk/support
IRELAND (EIRE)	0818 717100	www.samsung.com/ie/support
LITHUANIA	8-800-77777	www.samsung.com/lt/support
LATVIA	8000-7267	www.samsung.com/lv/support
ESTONIA	800-7267	www.samsung.com/ee/support
TURKEY	444 77 11	www.samsung.com/tr/support