

**SAMSUNG**

# USER MANUAL

---

**SERIES 6**







Thank you for purchasing this Samsung product.

To receive more complete service, please register your product at [www.samsung.com/register](http://www.samsung.com/register)

Model \_\_\_\_\_ Serial No. \_\_\_\_\_

# Warning! Important Safety Instructions

(Please read the Safety Instructions before using your TV.)

<b>CAUTION</b>	
<b>RISK OF ELECTRIC SHOCK DO NOT OPEN</b>	
<p>CAUTION: TO REDUCE THE RISK OF ELECTRIC SHOCK, DO NOT REMOVE COVER (OR BACK). THERE ARE NO USER SERVICEABLE PARTS INSIDE. REFER ALL SERVICING TO QUALIFIED PERSONNEL.</p>	
	<p>This symbol indicates that high voltage is present inside. It is dangerous to make any kind of contact with any internal part of this product.</p>
	<p>This symbol indicates that this product has included important literature concerning operation and maintenance.</p>
	<p>Class II product: This symbol indicates that it does not require a safety connection to electrical earth (ground).</p>
	<p>AC voltage: This symbol indicates that the rated voltage marked with the symbol is AC voltage.</p>
	<p>DC voltage: This symbol indicates that the rated voltage marked with the symbol is DC voltage.</p>
	<p>Caution, Consult Instructions for use: This symbol instructs the user to consult the user manual for further safety related information.</p>

The slots and openings in the cabinet and in the back or bottom are provided for necessary ventilation. To ensure reliable operation of this apparatus and to protect it from overheating, these slots and openings must never be blocked or covered.

- Do not place this apparatus in a confined space, such as a bookcase or built-in cabinet, unless proper ventilation is provided.
- Do not place this apparatus near or over a radiator or heat register, or where it is exposed to direct sunlight.
- Do not place vessels (vases etc.) containing water on this apparatus, as this can result in a fire or electric shock.

Do not expose this apparatus to rain or place it near water (near a bathtub, washbowl, kitchen sink, or laundry tub, in a wet basement, or near a swimming pool etc.). If this apparatus accidentally gets wet, unplug it and contact an authorised dealer immediately.

This apparatus uses batteries. In your community, there might be environmental regulations that require you to dispose of these batteries properly. Please contact your local authorities for disposal or recycling information.

Do not overload wall outlets, extension cords or adaptors beyond their capacity, since this can result in fire or electric shock.

Power-supply cords should be placed so that they are not likely to be walked on or pinched by items placed upon or against them. Pay particular attention to cords at the plug end, at wall outlets, and at the point where they exit from the appliance.

To protect this apparatus from a lightning storm, or when left unattended and unused for long periods of time, unplug it from the wall outlet and disconnect the antenna or cable system. This will prevent damage to the set due to lightning and power line surges.

Before connecting the AC power cord to the DC adaptor outlet, make sure that the voltage designation of the DC adaptor corresponds to the local electrical supply.

Never insert anything metallic into the open parts of this apparatus. This may cause a danger of electric shock.

To avoid electric shock, never touch the inside of this apparatus. Only a qualified technician should open this apparatus.

Be sure to plug in the power cord until it is firmly seated. When unplugging the power cord from a wall outlet, always pull on the power cord's plug. Never unplug it by pulling on the power cord. Do not touch the power cord with wet hands.

If this apparatus does not operate normally - in particular, if there are any unusual sounds or smells coming from it - unplug it immediately and contact an authorised dealer or service centre.

Be sure to pull the power plug out of the outlet if the TV is to remain unused or if you are to leave the house for an extended period of time (especially when children, elderly or disabled people will be left alone in the house).

- Accumulated dust can cause an electric shock, an electric leakage, or a fire by causing the power cord to generate sparks and heat or by causing the insulation to deteriorate.

Be sure to contact an authorised service centre for information if you intend to install your TV in a location with heavy dust, high or low temperatures, high humidity, chemical substances, or where it will operate 24 hours a day such as in an aerial port, a train station, etc. Failure to do so may lead to serious damage to your TV.

Use only a properly grounded plug and wall outlet.

- An improper ground may cause electric shock or equipment damage. (Class I Equipment only.)

To turn off this apparatus completely, disconnect it from the wall outlet. Be sure to have the wall outlet and power plug readily accessible.

Store the accessories (battery, etc.) in a location safely out of the reach of children.

Do not drop or strike the product. If the product is damaged, disconnect the power cord and contact a service centre.

To clean this apparatus, unplug the power cord from the wall outlet and wipe the product with a soft, dry cloth. Do not use any chemicals such as wax, benzene, alcohol, thinners, insecticide, aerial fresheners, lubricants, or detergents. These chemicals can damage the appearance of the TV or erase the printing on the product.

Do not expose this apparatus to dripping or splashing.

Do not dispose of batteries in a fire.

Do not short-circuit, disassemble, or overheat the batteries.

There is danger of an explosion if you replace the batteries used in the remote with the wrong type of battery. Replace only with the same or equivalent type.

# What's in the Box?

Make sure that the following items are included with your TV. If there are any items missing, contact your local dealer.

Samsung Smart Remote & Batteries (AA x 2)

Remote Control & Batteries (AAA x 2)

User Manual

Regulatory Guide

Power Cord

Warranty Card (Not available in some locations)

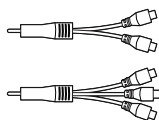

COMPONENT IN / AV IN Adapter

(Not available in some locations)

- The colours and shapes of the items differ with the model.
- Cables not supplied with this product can be purchased separately.
- Open the box and check for any accessory items hidden behind or inside the packing materials.



Warning: Screens can be damaged from direct pressure when handled incorrectly. We recommend lifting the TV at the edges, as shown.

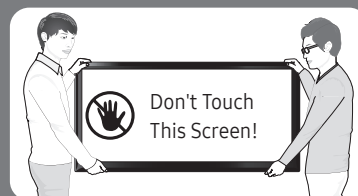

# About the Remote Control

Learn where the function buttons are on your remote, such as: SOURCE, MUTE,  $\wedge$  CH  $\vee$ , SPORTS, EXTRA,  $\square$ , INFO, CH LIST, RETURN and EXIT.

- This remote control has Braille points on the **Power**, **Channel**, **Volume**, and **Enter** buttons and can be used by visually impaired persons.

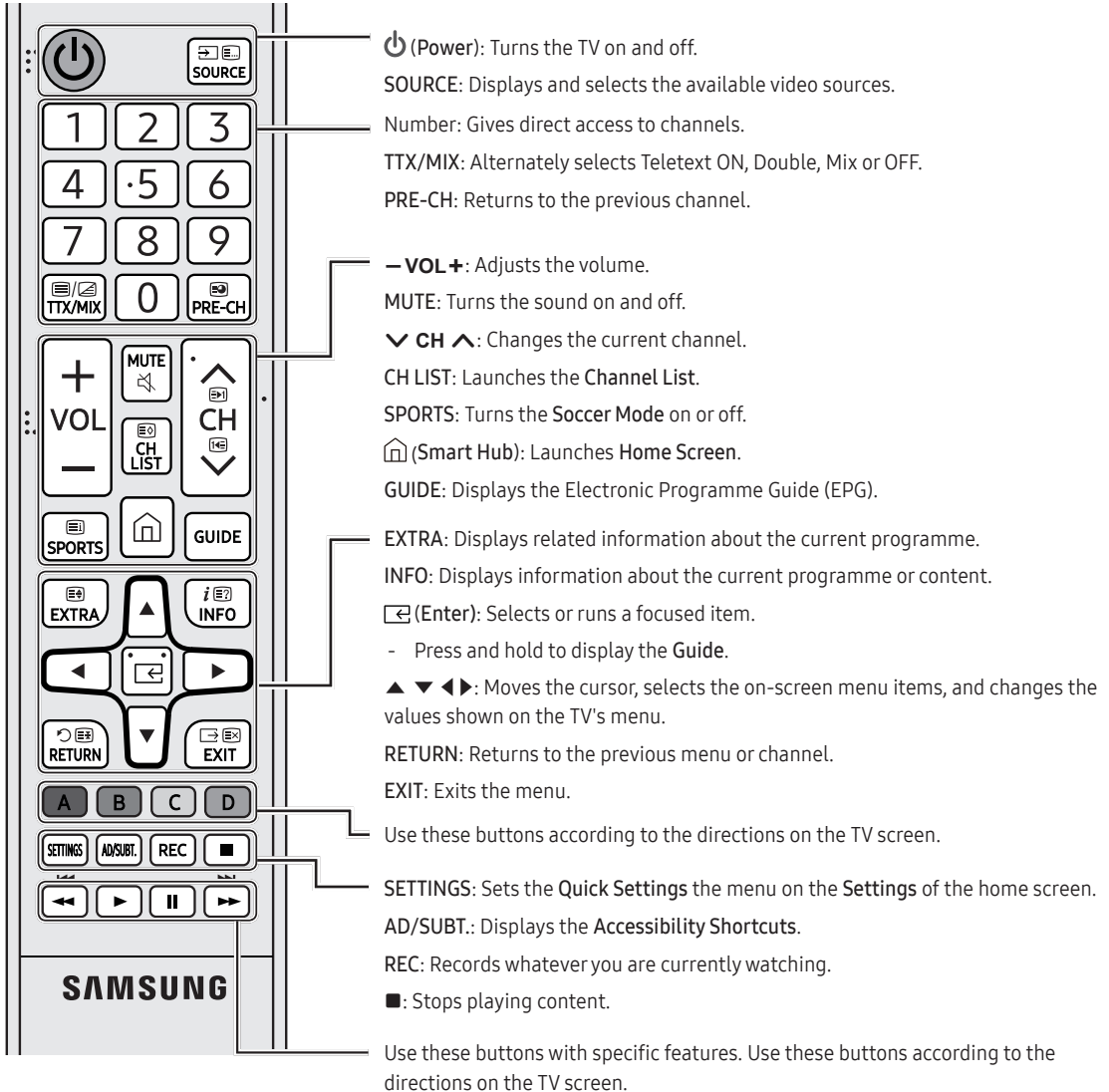

## Installing batteries into the remote control

Match the polarity of the batteries to the symbols on the battery compartment.

- Use the remote control within 7m of the TV.
- Bright light may affect the performance of the remote control. Avoid using near bright fluorescent lights or neon signs.
- The colour and shape of the remote may vary depending on the model.

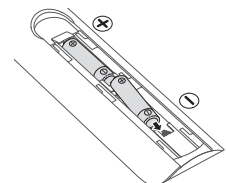

# About the Samsung Smart Remote

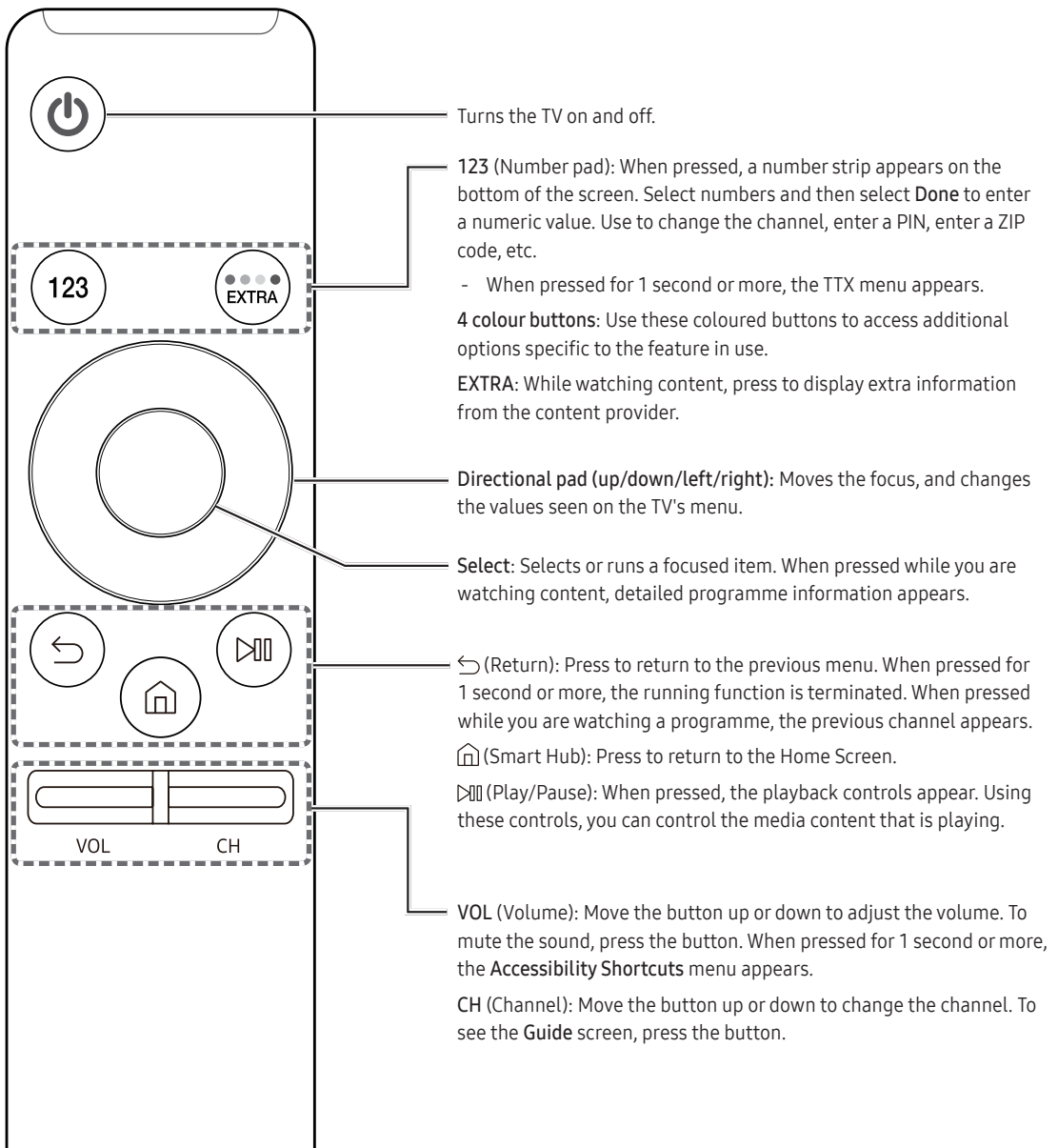

- When you are in a dark place, the Samsung Smart Remote lights up its buttons so that you can identify their printed names.

## Installing batteries into the Samsung Smart Remote

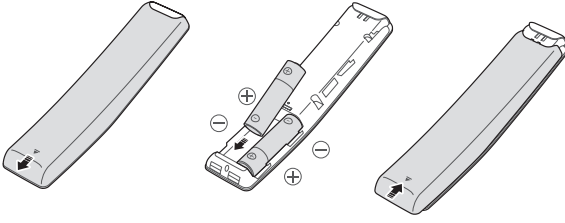

To install the batteries, push the rear cover open in the direction of the arrow and insert the batteries as shown in the figure. Make sure that the positive and negative ends are facing in the correct direction.

- Alkaline batteries are recommended for longer battery life.

## Using the TV Controller

Turn on the TV with the TV Controller button on the rear of the TV and then use the control menu. The Control menu appears when the button is pressed while the TV is On. For more information about its usage, refer to the figure below.

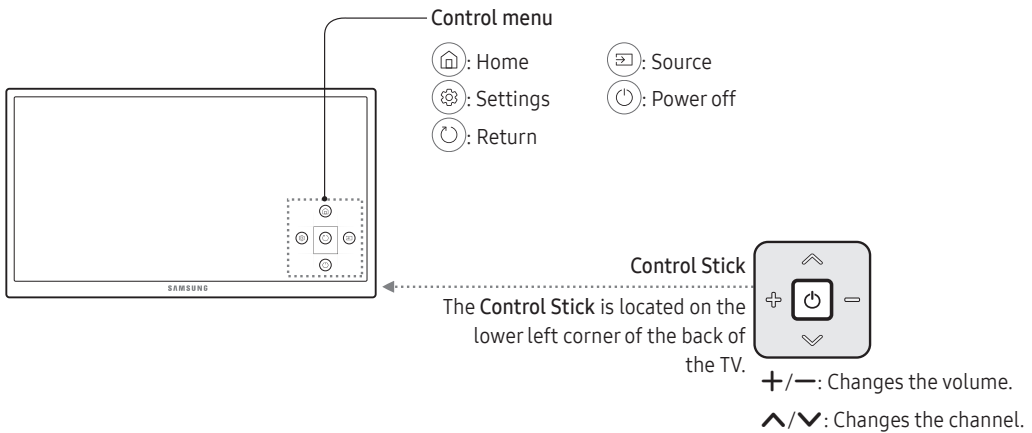

# Connecting to a Network

Connecting the TV to a network gives you access to online services, such as **Smart Hub**, as well as software updates.

## Network Connection - Wireless

Connect the TV to the Internet using a standard router or modem.

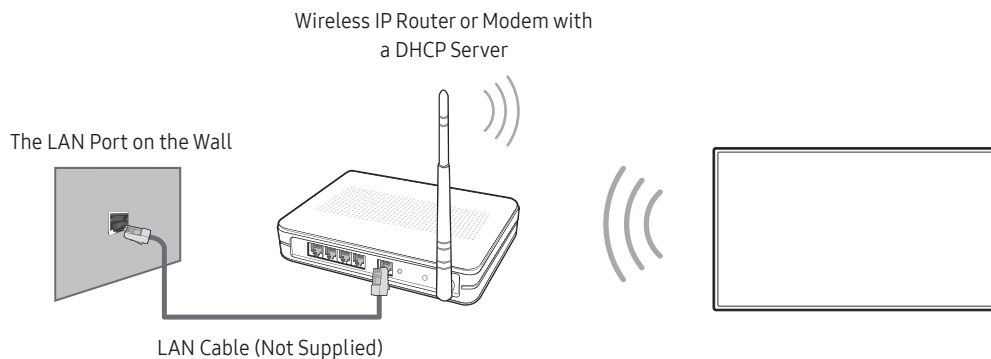

## Network Connection - Wired

TV Rear Panel

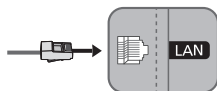

Connect your TV to your network using a LAN Cable.

- The TV does not support the network speeds less than or equal to 10 Mbps.
- Use a CAT 7 (\*STP type) cable for the connection.  
\* Shielded Twist Pair

# Mobile Network

Availability depends on the specific model and area.

While connecting to the mobile network, some functions might be unavailable.

Refer to the diagram and insert the Mobile Dongle (sold separately) into the USB port. The Mobile Dongle must be connected to the TV in order to connect to the mobile network. However, the Mobile Dongle is sold separately and is not available from Samsung.

If you have any problems using online services, please contact your Internet service provider.

- When you use a large mobile dongle(Data Card), USB devices may not work properly due to interferences among the USB ports, or the wireless network may not work properly due to interferences from the peripherals and surroundings. In this case, use a USB extension cable.

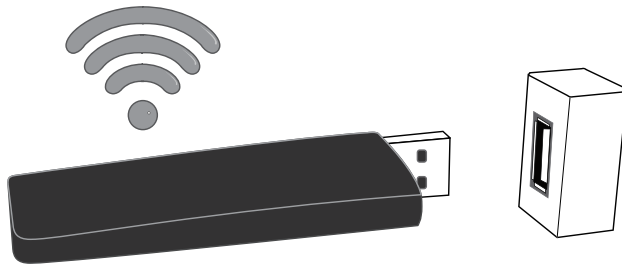

## Supported Telecom and Model Name

For more information, refer to the e-Manual.



# The e-Manual





The embedded e-Manual contains information about the key features of your TV.

- You can download and view a printable version of the e-Manual on the Samsung website.

Displaying the e-Manual:



- In the TV's menu, select  >  Settings > Support > Open e-Manual.

## Using the buttons in the e-Manual

	Search	Select an item from the search results to load the corresponding page.
A-Z	Index	Select a keyword to navigate to the relevant page.
	Recent pages	Select a topic from the list of recently viewed topics.
	Try Now	Allows you to access the corresponding menu item and try out the feature right away.
	Link	Allows you to access the corresponding reference page.

- Some menu screens cannot be accessed from the e-Manual.

## Initial Setup

The initial setup dialogue box appears when the TV is first activated. Follow the on-screen instructions to finish the initial setup process. You can manually perform this process at a later time in the  >  Settings > System > Start Setup menu.

# Troubleshooting and Maintenance

## Troubleshooting

If the TV seems to have a problem, first review this list of possible problems and solutions. Alternatively, review the Troubleshooting Section in the e-Manual. If none of these troubleshooting tips apply, please visit “www.samsung.com” and click on Support, or contact the call centre listed on the back cover of this manual.

- This TFT LED panel is made up of sub pixels which require sophisticated technology to produce. There may be, however, a few bright or dark pixels on the screen. These pixels will have no impact on the performance of the product.
- To keep your TV in optimum condition, upgrade to the latest software. Use the **Update now** or **Auto Update** functions on the TV's menu (🏠 > ⚙️ Settings > Support > Software Update > Update now or Auto Update).

### **The TV won't turn on.**

- Make sure that the AC power cord is securely plugged in to the TV and the wall outlet.
- Make sure that the wall outlet is working and the power indicator on the TV is lit and glowing a solid red.
- Try pressing the Power button on the TV to make sure that the problem is not with the remote control. If the TV turns on, refer to “Remote control does not work” below.

### **There is no picture/video/sound or distorted picture/video/sound from an external device or “Weak or No Signal” displayed on TV or cannot find channel.**

- Make sure the connection to the device is correct and that all cables are fully inserted.
- Remove and reconnect all cables connected to the TV and the external devices. Try new cables if possible.
- Confirm that the correct input source has been selected. (🏠 > Source).
- Perform a TV self diagnosis to determine if the problem is caused by the TV or the device. (🏠 > ⚙️ Settings > Support > Self Diagnosis > Start Sound Test or Start Picture Test).
- If the test results are normal, reboot the connected devices by unplugging each device's power cord and then plugging it in again. If the issue persists, refer to the connection guide in the user manual of the connected device.
- If the TV is not connected to a cable or satellite box, run **Auto Tuning** to search for channels (🏠 > ⚙️ Settings > Broadcasting > Auto Tuning).

### **The remote control does not work.**

- Check if the power indicator on the TV blinks when you press the remote's On button. If it does not, replace the remote control's batteries.
- Make sure that the batteries are installed with their poles (+/-) in the correct direction.
- Try pointing the remote directly at the TV from 1.5~1.8 m away.
- If your TV came with a Remote Control (Bluetooth Remote), make sure to pair the remote to the TV. (Please refer to the e-Manual.)

### **The cable or satellite box remote control doesn't turn the TV on or off or adjust the volume.**

- Programme the cable or satellite box remote control to operate the TV. Refer to the cable or satellite box user manual for the SAMSUNG TV code.

## The TV settings are lost after 5 minutes.

- The TV is in the Shop Mode. Change the Use Mode to Home Use. (Home > Settings > System > Expert Settings > Use Mode > Home Use).

## Intermittent Wi-Fi

- Make sure the TV has a network connection (Home > Settings > Network > Network Status).
- Make sure the Wifi password is entered correctly.
- Check the distance between the TV and the Modem/Router. The distance should not exceed 15.2 m.
- Reduce interference by not using or turning off wireless devices. Also, verify that there are no obstacles between the TV and the Modem/Router.

(The Wi-Fi strength can be decreased by appliances, cordless phones, stone walls/fireplaces, etc.)

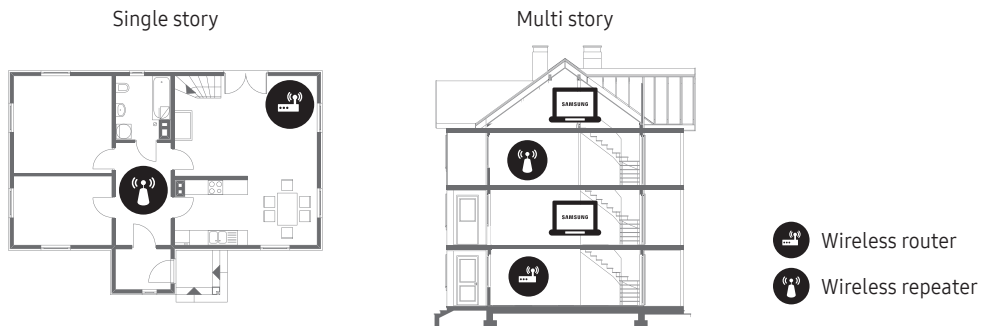

- Contact your ISP and ask them to reset your network circuit to re-register the Mac addresses of your new Modem/Router and the TV.

## Video App problems (Youtube etc)

- Change the DNS to 8.8.8.8. Select (Home > Settings > Network > Network Status > IP Settings > DNS setting > Enter manually > DNS Server > enter 8.8.8.8 > OK
- Reset by selecting (Home > Settings > Support > Self Diagnosis > Reset Smart Hub.

# What is Remote Support?

Samsung Remote Support service offers you one-on-one support with a Samsung Technician who can remotely:



- Diagnose your TV
- Adjust the TV settings for you
- Perform a factory reset on your TV
- Install recommended firmware updates

## How does Remote Support work?

You can easily have a Samsung Tech service your TV remotely:

1. Call the Samsung Contact Centre and ask for remote support.
2. Open the menu on your TV and go to the **Support** section.
3. Select **Remote Management**, then read and agree to the service agreements. When the PIN screen appears, provide the PIN number to the agent.
4. The agent will then access your TV.

## Eco Sensor and screen brightness

Eco Sensor adjusts the brightness of the TV automatically. This feature measures the light in your room and optimises the brightness of the TV automatically to reduce power consumption. If you want to turn this off, go to  >  **Settings** > **System** > **Eco Solution** > **Eco Sensor**.

- If the screen is too dark while you are watching TV in a dark environment, it may be due to the **Eco Sensor**.
- Do not block the sensor with any object. This can decrease picture brightness.

## Still image warning

Avoid displaying still images (such as jpeg picture files), still image elements (such as TV channel logos, stock or news crawls at the screen bottom etc.), or programmes in panorama or 4:3 image format on the screen. If you constantly display still pictures, it can cause image burn-in on the LED screen and affect image quality. To reduce the risk of this adverse effect, please follow the recommendations below:

- Avoid displaying the same TV channel for long periods.
- Always try to display any image in full screen. Use the picture format menu of the TV set for the best possible match.
- Reduce brightness and contrast to avoid the appearance of after-images.
- Use all TV features designed to reduce image retention and screen burn. Refer to the **e-Manual** for details.

## Caring for the TV

- If a sticker was attached to the TV screen, some debris can remain after you remove the sticker. Please clean the debris off before watching TV.
- The exterior and screen of the TV can get scratched during cleaning. Be sure to wipe the exterior and screen carefully using a soft cloth to prevent scratches.

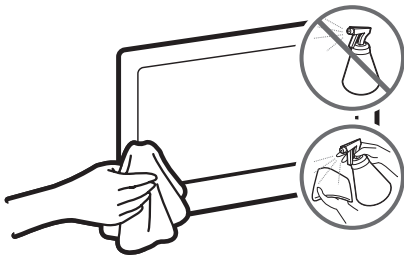

- Do not spray water or any liquid directly onto the TV. Any liquid that goes into the product may cause a failure, fire, or electric shock.
- Turn off the TV, then gently wipe away smudges and fingerprints on the screen with a micro-fiber cloth. Clean the body of the TV with a soft cloth dampened with a small amount of water. Do not use flammable liquids (benzene, thinners, etc.) or a cleaning agent. For stubborn smudges, spray a small amount of screen cleaner on the cloth.

# TV Installation

## Mounting the TV on a wall



If you mount this TV on a wall, follow the instructions exactly as set out by the manufacturer. Unless it is correctly mounted, the TV may slide or fall and cause serious injury to a child or adult and serious damage to the TV.

For models providing wall mount adapters, install them as shown in the figures below before installing the wall mount kit.

- Refer to the installation manual included with the Samsung wall mount kit.

Samsung Electronics is not responsible for any damage to the product or injury to yourself or others if you choose to install the wall mount on your own.

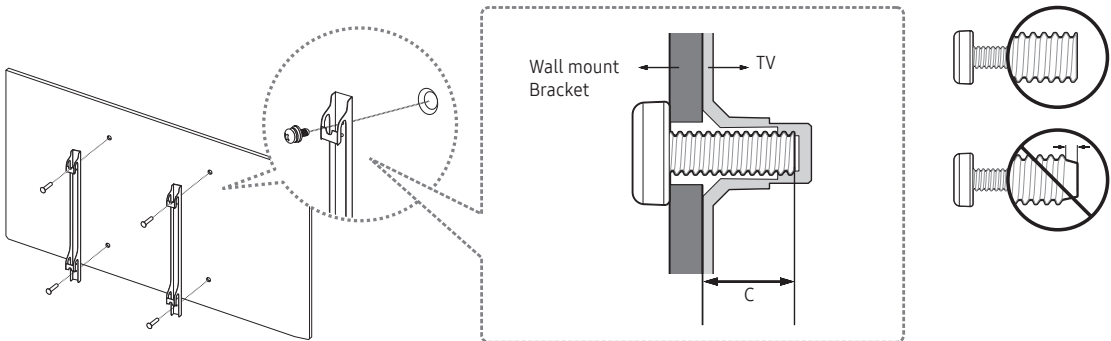

## VESA wall mount kit notes and specifications

You can install your wall mount on a solid wall perpendicular to the floor. Before attaching the wall mount to surfaces other than plaster board, contact your nearest dealer for additional information. If you install the TV on a ceiling or slanted wall, it may fall and result in severe personal injury.

Standard dimensions for wall mount kits are shown in the table below.

If you are installing a third-party wall mount, note that the length of the screws you can use to attach the TV to the wall mount is shown in column C in the table below.

TV size in inches	VESA screw hole specs (A * B) in millimetres	C (mm)	Standard Screw	Quantity
40 ~ 43	200 x 200	20.7 ~ 21.7	M8	4
50 ~ 65	400 x 400			

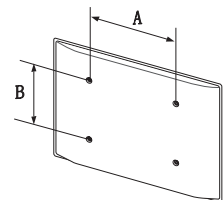



Do not install your wall mount kit while your TV is turned on. This may result in personal injury from electric shock.

- Do not use screws that are longer than the standard dimension or do not comply with the VESA standard screw specifications. Screws that are too long may cause damage to the inside of the TV set.
- For wall mounts that do not comply with the VESA standard screw specifications, the length of the screws may differ depending on the wall mount specifications.
- Do not fasten the screws too firmly. This may damage the product or cause the product to fall, leading to personal injury. Samsung is not liable for these kinds of accidents.
- Samsung is not liable for product damage or personal injury when a non-VESA or non-specified wall mount is used or the consumer fails to follow the product installation instructions.
- Do not mount the TV at more than a 15 degree tilt.
- Always have two people mount the TV onto a wall.

## Providing proper ventilation for your TV

When you install your TV, maintain a distance of at least 10 cm between the TV and other objects (walls, cabinet sides, etc.) to ensure proper ventilation. Failing to maintain proper ventilation may result in a fire or a problem with the product caused by an increase in its internal temperature.

When you install your TV with a stand or a wall mount, we strongly recommend you use parts provided by Samsung Electronics only. Using parts provided by another manufacturer may cause difficulties with the product or result in injury caused by the product falling.

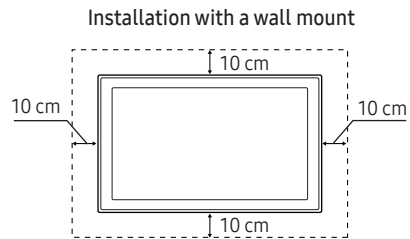
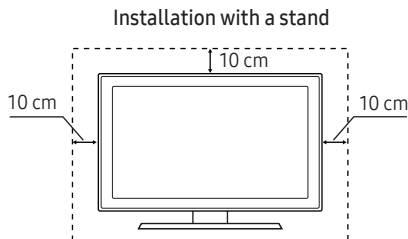

# Attaching the TV to the Stand

Make sure you have all the accessories shown, and that you assemble the stand following the provided assembly instructions.

## Safety Precaution: Securing the TV to the wall



**Caution:** Pulling, pushing, or climbing on the TV may cause the TV to fall. In particular, ensure your children do not hang on or destabilise the TV. This action may cause the TV to tip over, causing serious injuries or death. Follow all safety precautions provided in the Safety Flyer included with your TV. For added stability and safety, you can purchase and install the anti-fall device as described below.



Never place a television set in an unstable location. A television set may fall, causing serious personal injury or death. Many injuries, particularly to children, can be avoided by taking simple precautions such as:

- Using cabinets or stands recommended by the manufacturer of the television set.
- Only using furniture that can safely support the television set.
- Ensuring the television set is not overhanging the edge of the supporting furniture.
- Not placing the television set on tall furniture (for example, cupboards or bookcases) without anchoring both the furniture and the television set to a suitable support.
- Not placing the television set on cloth or other materials that may be located between the television set and supporting furniture.
- Educating children about the dangers of climbing on furniture to reach the television set or its controls.

If your existing television set is being retained and relocated, the same considerations as above should be applied.

## Preventing the TV from falling

1. Put the screws into one set of brackets, and then firmly fasten them to the wall. Confirm that the screws are firmly attached to the wall.
  - You may need additional material such as wall anchors depending on the type of wall.
2. Put the screws into a second set of brackets, and then fasten the screws to the TV.
  - Screws may not be supplied with the product. In this case, please purchase the screws of the following specifications.
3. Connect the brackets fixed to the TV and the brackets fixed to the wall with a durable, heavy-duty string, and then tie the string tightly.
  - Install the TV near the wall so that it does not fall backwards.
  - Connect the string so that the brackets fixed to the wall are at the same height as or lower than the brackets fixed to the TV.

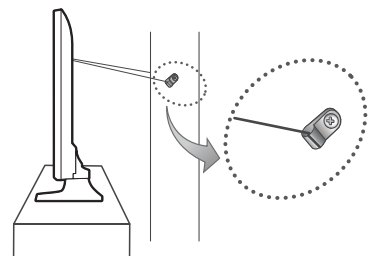
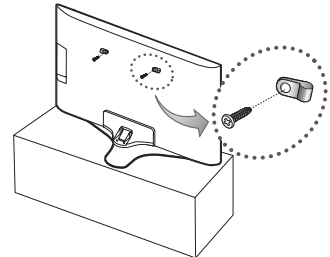

# Specifications and Other Information

## Specifications

Display Resolution	3840 x 2160	
Environmental Considerations		
Operating Temperature	10°C to 40°C (50°F to 104°F)	
Operating Humidity	10% to 80%, non-condensing	
Storage Temperature	-20°C to 45°C (-4°F to 113°F)	
Storage Humidity	5% to 95%, non-condensing	
Stand Swivel (Left / Right)	0°	
Sound (Output)	20W	
Model Name	UA40KU6000	UA43KU6000
Screen Size (Diagonal)	101 cm	108 cm
Dimensions (W x H x D)		
Body	91.77 x 53.57 x 6.26 cm	97.58 x 56.90 x 6.26 cm
With Stand	91.77 x 59.65 x 28.81 cm	97.58 x 63.70 x 28.81 cm
Weight		
Without Stand	7.7 kg	8.8 kg
With Stand	8.6 kg	9.7 kg
Model Name	UA50KU6000	UA55KU6000
Screen Size (Diagonal)	125 cm	138 cm
Dimensions (W x H x D)		
Body	112.89 x 65.44 x 6.32 cm	124.26 x 71.84 x 6.32 cm
With Stand	112.89 x 72.37 x 31.05 cm	124.26 x 78.75 x 31.05 cm
Weight		
Without Stand	12.2 kg	15.0 kg
With Stand	13.2 kg	16.0 kg
Model Name	UA60KU6000	UA65KU6000
Screen Size (Diagonal)	152 cm	163 cm
Dimensions (W x H x D)		
Body	136.36 x 78.95 x 6.40 cm	146.35 x 84.45 x 6.46 cm
With Stand	136.36 x 85.28 x 36.94 cm	146.35 x 90.76 x 36.94 cm
Weight		
Without Stand	20.9 kg	23.7 kg
With Stand	22.9 kg	25.8 kg

- The design and specifications are subject to change without prior notice.
- For information about the power supply, and about power consumption, refer to the label attached to the product.



## Decreasing power consumption

When you shut the TV off, it enters Standby mode. In Standby mode, it continues to draw a small amount of power. To decrease power consumption, unplug the power cord when you don't intend to use the TV for a long time.

## Licences



## HDMI

The terms HDMI and HDMI High-Definition Multimedia Interface, and the HDMI Logo are trademarks or registered trademarks of HDMI Licensing LLC in the United States and other countries.

## For India only

This product is RoHS compliant.



This marking on the product, accessories or literature indicates that the product and its electronic accessories should not be disposed of with other household waste at the end of their working life. To prevent possible harm to the environment or human health from uncontrolled waste disposal, please separate these items from other types of waste and recycle them responsibly to promote the sustainable reuse of material resources.

For more information on safe disposal and recycling visit our website [www.samsung.com/in](http://www.samsung.com/in) or contact our Helpline numbers -18002668282, 180030008282.

**WARNING - TO PREVENT THE SPREAD OF FIRE, KEEP CANDLES OR OTHER ITEMS WITH OPEN FLAMES AWAY FROM THIS PRODUCT AT ALL TIMES.**



This page is intentionally  
left blank.

# SAMSUNG

## Contact SAMSUNG WORLD WIDE

If you have any questions or comments relating to Samsung products, please contact the SAMSUNG customer care centre.

Country	Customer Care Centre ☎	Web Site
SINGAPORE	1800-SAMSUNG(726-7864)	<a href="http://www.samsung.com/sg/support">www.samsung.com/sg/support</a>
AUSTRALIA	1300 362 603	<a href="http://www.samsung.com/au/support">www.samsung.com/au/support</a>
NEW ZEALAND	0800 726 786	<a href="http://www.samsung.com/nz/support">www.samsung.com/nz/support</a>
VIETNAM	1800 588 889	<a href="http://www.samsung.com/vn/support">www.samsung.com/vn/support</a>
THAILAND	0-2689-3232, 1800-29-3232	<a href="http://www.samsung.com/th/support">www.samsung.com/th/support</a>
MYANMAR	+95-1-2399-888	<a href="http://www.samsung.com/th/support">www.samsung.com/th/support</a>
MALAYSIA	1800-88-9999 603-77137477 (Overseas contact)	<a href="http://www.samsung.com/my/support">www.samsung.com/my/support</a>
INDONESIA	021-56997777 08001128888	<a href="http://www.samsung.com/id/support">www.samsung.com/id/support</a>
PHILIPPINES	1-800-10-726-7864 [ PLDT Toll Free ] 1-800-8-726-7864 [ Globe Landline and Mobile ] 02- 422-2111 [ Standard Landline ]	<a href="http://www.samsung.com/ph/support">www.samsung.com/ph/support</a>
TAIWAN	0800-329999	<a href="http://www.samsung.com/tw/support">www.samsung.com/tw/support</a>
JAPAN	0120-363-905	<a href="http://www.samsung.com/jp/support">www.samsung.com/jp/support</a>
INDIA	1800 3000 8282 - Toll Free 1800 266 8282 - Toll Free	<a href="http://www.samsung.com/in/support">www.samsung.com/in/support</a>
BANGLADESH	0961-2300300 0800-0300300 (Toll Free)	<a href="http://www.samsung.com/in/support">www.samsung.com/in/support</a>
SRI LANKA	0117540540 0115900000	<a href="http://www.samsung.com/support">www.samsung.com/support</a>
EGYPT	08000-7267864 16580	<a href="http://www.samsung.com/eg/support">www.samsung.com/eg/support</a>
ALGERIA	3004	<a href="http://www.samsung.com/n_africa/support">www.samsung.com/n_africa/support</a>
IRAN	021-8255 [CE]	<a href="http://www.samsung.com/iran/support">www.samsung.com/iran/support</a>
SAUDI ARABIA	800 247 3457 (800 24/7 HELP)	<a href="http://www.samsung.com/sa/home">www.samsung.com/sa/home</a> <a href="http://www.samsung.com/sa_en">www.samsung.com/sa_en</a>
PAKISTAN	0800-Samsung (72678)	<a href="http://www.samsung.com/pk/support">www.samsung.com/pk/support</a>
TUNISIA	80 1000 12	<a href="http://www.samsung.com/n_africa/support">www.samsung.com/n_africa/support</a>
U.A.E	800-SAMSUNG (800 - 726 7864)	<a href="http://www.samsung.com/ae/support">www.samsung.com/ae/support</a> (English) <a href="http://www.samsung.com/ae_ar/support">www.samsung.com/ae_ar/support</a> (Arabic)
OMAN	800-SAMSUNG (800 - 726 7864)	
KUWAIT	183-CALL (183-2255)	
BAHRAIN	8000-GSAM (8000-4726)	
QATAR	800-CALL (800-2255)	
TURKEY	444 77 11	<a href="http://www.samsung.com/tr/support">www.samsung.com/tr/support</a>
JORDAN	0800-22273 06 5777444	<a href="http://www.samsung.com/levant">www.samsung.com/levant</a>
SYRIA	962 5777444	
LEBANON	961 1484 999	
IRAQ	964 77 261 72220 964 75 118 92525	
MOROCCO	080 100 22 55	<a href="http://www.samsung.com/n_africa/support">www.samsung.com/n_africa/support</a>

