



**Contact SAMSUNG WORLD WIDE**

If you have any questions or comments relating to Samsung products, please contact the SAMSUNG customer care centre.

Country	Customer Care Centre ☎	Web Site
AUSTRALIA	1300 362 603	<a href="http://www.samsung.com/au/support">www.samsung.com/au/support</a>
NEW ZEALAND	0800 SAMSUNG (0800 726 786)	<a href="http://www.samsung.com/nz/support">www.samsung.com/nz/support</a>
CHINA	400-810-5858	<a href="http://www.samsung.com/cn/support">www.samsung.com/cn/support</a>
HONG KONG	(852) 3698 4698	<a href="http://www.samsung.com/hk/support">www.samsung.com/hk/support</a> (Chinese) <a href="http://www.samsung.com/hk_en/support">www.samsung.com/hk_en/support</a> (English)
INDIA	1800 3000 8282 - Toll Free 1800 266 8282 - Toll Free	<a href="http://www.samsung.com/in/support">www.samsung.com/in/support</a>
INDONESIA	0800112888 021-56997777	<a href="http://www.samsung.com/id/support">www.samsung.com/id/support</a>
JAPAN	0120-327-527	<a href="http://www.samsung.com/jp/support">www.samsung.com/jp/support</a>
MALAYSIA	1800-88-9999	<a href="http://www.samsung.com/my/support">www.samsung.com/my/support</a>
PHILIPPINES	1-800-10-7267864 [PLDT] 1-800-8-7267864 [Globe landline and Mobile] 02-4222111 [Other landline]	<a href="http://www.samsung.com/ph/support">www.samsung.com/ph/support</a>
SINGAPORE	1800-SAMSUNG(726-7864)	<a href="http://www.samsung.com/sg/support">www.samsung.com/sg/support</a>
THAILAND	0-2689-3232, 1800-29-3232	<a href="http://www.samsung.com/th/support">www.samsung.com/th/support</a>
TAIWAN	0800-32-9999	<a href="http://www.samsung.com/tw/support">www.samsung.com/tw/support</a>
VIETNAM	1 800 588 889	<a href="http://www.samsung.com/vn/support">www.samsung.com/vn/support</a>
GEORGIA	0-800-555-555	<a href="http://www.samsung.com/support">www.samsung.com/support</a>
ARMENIA	0-800-05-555	<a href="http://www.samsung.com/support">www.samsung.com/support</a>
AZERBAIJAN	088-55-55-555	<a href="http://www.samsung.com/support">www.samsung.com/support</a>
UZBEKISTAN	8-10-800-500-55-500	<a href="http://www.samsung.com/support">www.samsung.com/support</a>
KYRGYZSTAN	8-10-800-500-55-500	<a href="http://www.samsung.com/kz_ru/support">www.samsung.com/kz_ru/support</a>
TADJIKISTAN	8-10-800-500-55-500	<a href="http://www.samsung.com/support">www.samsung.com/support</a>
MONGOLIA	'7-800-555-55-55	<a href="http://www.samsung.com/support">www.samsung.com/support</a>
BELARUS	810-800-500-55-500	<a href="http://www.samsung.com/support">www.samsung.com/support</a>
MOLDOVA	0-800-614-40	<a href="http://www.samsung.com/support">www.samsung.com/support</a>
ALGERIA	021 36 11 00	<a href="http://www.samsung.com/n_africa/support">www.samsung.com/n_africa/support</a>
PAKISTAN	0800-Samsung (72678)	<a href="http://www.samsung.com/pk/support">www.samsung.com/pk/support</a>
TUNISIA	80-1000-12	<a href="http://www.samsung.com/n_africa/support">www.samsung.com/n_africa/support</a>



# LED TV

## user manual

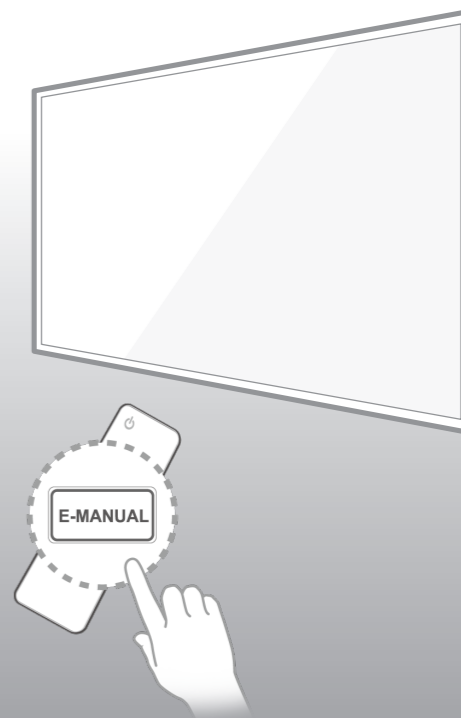

Thank you for purchasing this Samsung product.  
 To receive more complete service, please register  
 your product at  
[www.samsung.com/register](http://www.samsung.com/register)  
 Model \_\_\_\_\_ Serial No. \_\_\_\_\_



BN68-06310U-00

# Important Safety Instructions

**SAMSUNG**

## Warning! Important Safety Instructions

(Please read the appropriate section that corresponds to the marking on your Samsung product before attempting to install the product.)

### CAUTION

#### RISK OF ELECTRIC SHOCK DO NOT OPEN

CAUTION: TO REDUCE THE RISK OF ELECTRIC SHOCK, DO NOT REMOVE COVER (OR BACK). THERE ARE NO USER SERVICEABLE PARTS INSIDE. REFER ALL SERVICING TO QUALIFIED PERSONNEL.



This symbol indicates that high voltage is present inside. It is dangerous to make any kind of contact with any internal part of this product.



This symbol alerts you that important literature concerning operation and maintenance has been included with this product.

- The slots and openings in the cabinet and in the back or bottom are provided for necessary ventilation. To ensure reliable operation of this apparatus, and to protect it from overheating, these slots and openings must never be blocked or covered.
  - Do not cover this apparatus in a confined space, such as a bookcase, or built-in cabinet, unless proper ventilation is provided.
  - Do not place this apparatus near or over a radiator or heat resistor, or where it is exposed to direct sunlight.
  - Do not place a water containing vessel (vases etc.) on this apparatus, as this can result in a risk of fire or electric shock.
- Do not expose this apparatus to rain or place it near water (near a bathtub, washbowl, kitchen sink, or laundry tub, in a wet basement, or near a swimming pool etc.). If this apparatus accidentally gets wet, unplug it and contact an authorised dealer immediately. Make sure to pull out the power cord from the outlet before cleaning.
- This apparatus use batteries. In your community there might be regulations that require you to dispose of these batteries properly under environmental considerations. Please contact your local authorities for disposal or recycling information.
- Do not overload wall outlets, extension cords or adaptors beyond their capacity, since this can result in fire or electric shock.
- Power-supply cords should be routed so that they are not likely to be walked on or pinched by items placed upon or against them, paying particular attention to cords at plug end, adaptors and the point where they exit from the appliance.
- To protect this apparatus from a lightning storm, or when it is left unattended and unused for long periods of time, unplug it from the wall outlet and disconnect the antenna or cable system. This will prevent damage to the set due to lightning and power line surges.
- Before connecting the AC power cord to the DC adaptor outlet, make sure the voltage designation of the DC adaptor corresponds to the local electrical supply.
- Never insert anything metallic into the open parts of this apparatus. Doing so may create a danger of electric shock.
- To avoid electric shock, never touch the inside of this apparatus. Only a qualified technician should open this apparatus.
- Make sure to plug the power cord in until it is firmly inserted. When removing the power cord, make sure to hold the power plug when pulling the plug from the outlet. Do not touch the power cord with wet hands.
- If this apparatus does not operate normally - in particular, if there are any unusual sounds or smells coming from it - unplug it immediately and contact an authorised dealer or service centre.
- Be sure to pull the power plug out of the outlet if the TV is to remain unused or if you are to leave the house for an extended period of time (especially when children, elderly or disabled people will be left alone in the house).
  - Accumulated dust can cause an electric shock, an electric leakage or a fire by causing the power cord to generate sparks and heat or the insulation to deteriorate.
- Be sure to contact an authorised service centre, when installing your set in a location with heavy dust, high or low temperatures, high humidity, chemical substances or where it will operate for 24 hours a day such as in an airport, a train station, etc. Failure to do so may cause serious damage to your set.
- Use only a properly grounded plug and receptacle.
- An improper ground may cause electric shock or equipment damage. (Class I Equipment only.)
- To disconnect the apparatus from the mains, the plug must be pulled out from the mains socket, therefore the mains plug shall be readily operable.
- Do not allow children to hang onto the product.
- Store the accessories (battery, etc.) in a location safely out of the reach of children.
- Do not install the product in an unstable location such as a shaky self, a slanted floor or a location exposed to vibration.
- Do not drop or impart any shock to the product. If the product is damaged, disconnect the power cord and contact a service centre.
- Unplug the power cord from the power outlet and wipe the product using a soft, dry cloth. Do not use any chemicals such as wax, benzene, alcohol, thinners, insecticide, aerial freshener, lubricant or detergent. This may damage the appearance or erase the printing on the product.
- Apparatus shall not be exposed to dripping or splashing.
- Do not dispose of batteries in a fire.
- Do not short circuit, disassemble or overheat the batteries.
- Danger of explosion if battery is incorrectly replaced. Replace only with the same or equivalent type.
- **WARNING - TO PREVENT THE SPREAD OF FIRE, KEEP CANDLES OR OTHER OPEN FLAMES AWAY FROM THIS PRODUCT AT ALL TIMES.**



Figures and illustrations in this User Manual are provided for reference only and may differ from actual product appearance. Product design and specifications may be changed without notice.

---

## List of Features

- **Media Play:** Allows you to play music files, pictures, and movies saved on a USB device.
- **e-Manual:** Allows you to read on screen full manual. (p. 7)

---

## Accessories

- ✎ Please make sure the following items are included with your TV. If any items are missing, contact your dealer.
- ✎ The items' colours and shapes may vary depending on the models.
- ✎ Cables not included in the package contents can be purchased separately.

- Remote Control & Batteries (AAA x 2)
- Power Cord
- Regulatory Guide / Warranty Card
- Owner's Instructions



Cable Holder

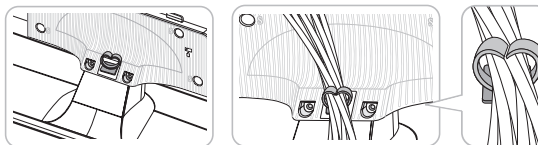

Assembling the Cable Holder

# Viewing the Remote Control

 This remote control has Braille points on the **Power**, **Channel**, and **Volume** buttons and can be used by visually impaired persons.

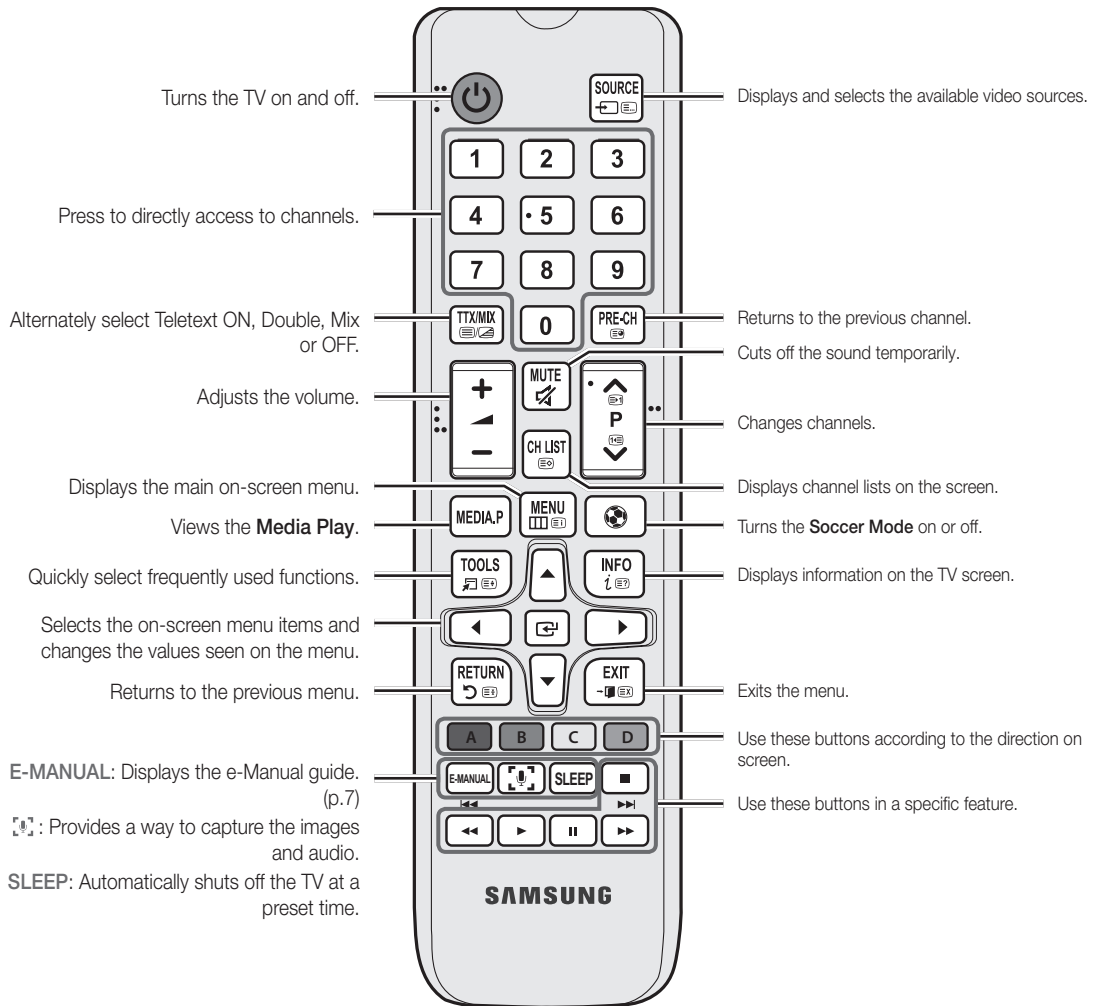

## Installing batteries (Battery size: AAA)

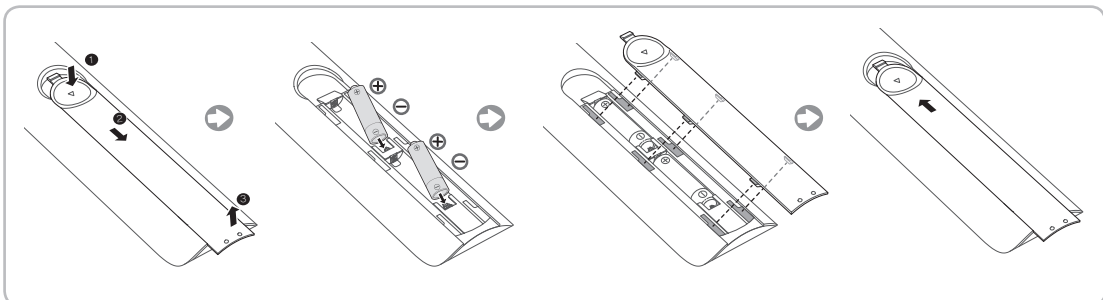

---

## Using the TV's Controller (Panel Key)

The TV's Controller, a small joy stick like button on the rear left side of the TV, lets you control the TV without the remote control.

- Some functions which require a PIN code may not be available.
- The product colour and shape may vary depending on the model.
- Exits the menu when pressing the controller more than 1 second.
- When using the controller in the up/down/left/right directions, make sure you do not push the controller in first. If you push the controller in first it will not move in the up/down/left right directions.

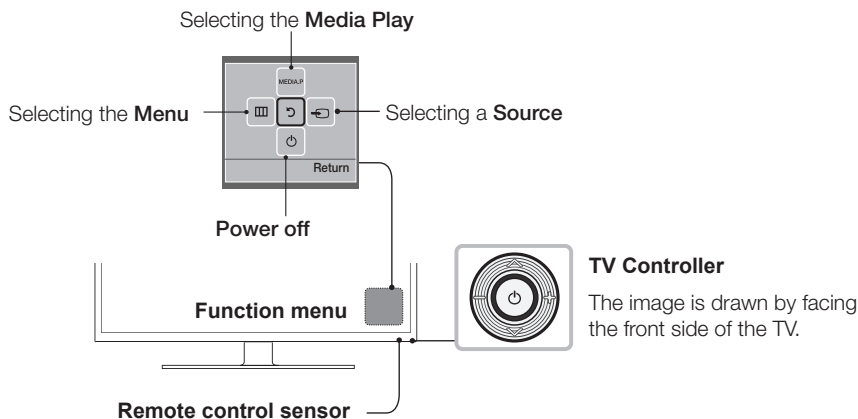

### Standby mode

Do not leave your TV in standby mode for long periods of time (when you are away on a holiday, for example). A small amount of electric power is still consumed even when the power button is turned off. It is best to unplug the power cord.

---

## Initial Setup

When the TV is initially powered on, a sequence of on-screen prompts will assist in configuring basic settings. Press the **POWER** button. **Setup** is available only when the source is set to TV.

- If you connect any device to **HDMI IN 1(STB)** before starting the installation, **Channel Source** will be changed to **Set-top box** automatically. If you do not want to select **Set-top box**, please select **Aerial**.

### If You Want to Reset This Feature...

Select **System - Setup** (Initial Setup). Enter your 4 digit PIN number. The default password is "0-0-0-0". If you want to change the PIN number, use the **Change PIN** function.

You should do **Setup (MENU → System)** again at home even though you did in shop already.

- If you forget the PIN code, press the remote control buttons in the following sequence in Standby mode, which resets the PIN to "0-0-0-0": **MUTE → 8 → 2 → 4 → POWER (on)**

# Changing the Input Source

## Source

### TV / HDMI1 / HDMI2/DVI / AV / Component

Use to select TV or other external input sources such as DVD / Blu-ray players / cable box / STB satellite receiver connected to the TV.

- ✎ Press the **SOURCE** button. In the displayed **Source** list, connected inputs will be highlighted.
- ✎ PC(D-Sub) input is not supported. If you want to connect PC to the TV, you can connect the HDMI to DVI cable with the **HDMI IN 2(DVI)** port on the TV.
- ✎ Press the **TOOLS** button.
  - **Edit Name**

You can set an external input source name you want.

    - When connecting a PC to the **HDMI IN 2(DVI)** port with HDMI cable, you should set the TV to **PC** mode under **Edit Name**.
    - When connecting a PC to the **HDMI IN 2(DVI)** port with HDMI to DVI cable, you should set the TV to **DVI PC** mode under **Edit Name**.
    - When connecting an AV devices to the **HDMI IN 2(DVI)** port with HDMI to DVI cable, you should set the TV to **DVI Devices** mode under **Edit Name**.
  - **Information**

You can see detailed information about the connected external device.

# How to use the e-Manual

**E-MANUAL**



You can find instructions about your TV's features in the **e-Manual** in your TV. To use, press the **E-MANUAL** button on your remote. Move the cursor using the up/down/right/left buttons to highlight a category, then a topic, and then press the **ENTER** button. The **e-Manual** displays the page you want to see.

You can also access it through the menu:

 **MENU** → **Support** → **e-Manual** → **ENTER**

 To return to the **e-Manual** main menu, press the **E-MANUAL** button on the remote.

## Screen Display

Currently displayed  
video, TV  
Programme, etc.

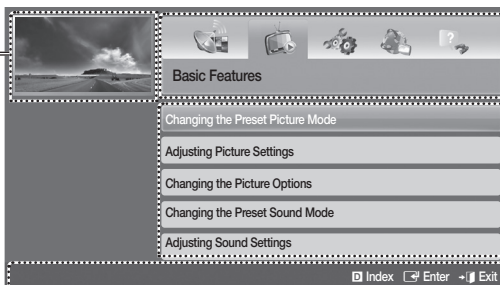

The category list. Press ◀ or ▶ button to select the category you want.

Displays the sub-menu list. Use the arrow buttons on your remote to move the cursor. Press **ENTER** button to select the sub-menu you want.

## Operation Buttons

**Index**: Displays the index screen.

- Index available depending on the language.

**Enter**: Selects a category or sub-menu.

**Exit**: Exit the e-Manual.

<Viewing the Contents>

**Try now**: Displays the OSD menu that corresponds to the topic. To return to the e-Manual screen, press the **E-MANUAL** button.



**Home**: Moves to the e-Manual home screen.

**Page**: Moves to previous or next page.

**Zoom**: Magnifies a screen.



- Press the **Zoom** button to magnify the screen. You can scroll through the magnified screen by using the ▲ or ▼ buttons. To return to the screen to normal size, press the **RETURN** button.

## How to toggle between an e-Manual topic and the corresponding OSD menu(s).

-  This function is not enabled in some menus.
-  You cannot use the **Try now** function if the menu is not activated.

Method 1	Method 2
<ol style="list-style-type: none"><li>1. If you want to use the menu that corresponds to an <b>e-Manual</b> topic, press the red button to select <b>Try now</b>.</li><li>2. To return to the <b>e-Manual</b> screen, press the <b>E-MANUAL</b> button.</li></ol>	<ol style="list-style-type: none"><li>1. Press the <b>ENTER</b> button when a topic is displayed. "<b>Are you sure?</b>" appears. Select <b>Yes</b>, and then press the <b>ENTER</b> button. The OSD window appears.</li><li>2. To return to the <b>e-Manual</b> screen, press the <b>E-MANUAL</b> button.</li></ol>

## How to search for a topic on the index page

-  This function may not be supported depending on the language.
1. If you want to search a keyword, press the blue button to select **Index**.
  2. Press the ◀ or ▶ button to select a character order you want.
  3. Press the ▲ or ▼ button to select a keyword you want to see, and then press the **ENTER** button.
  4. You can view the corresponding e-Manual instruction screen.
    -  To close the **Index** screen, press the **RETURN** button.









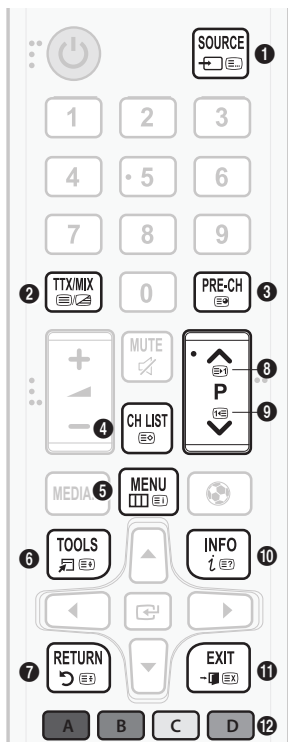





# Teletext Feature

The index page of the Teletext service gives you information on how to use the service. For Teletext information to be displayed correctly, channel reception must be stable. Otherwise, information may be missing or some pages may not be displayed.

 You can change Teletext pages by pressing the numeric buttons on the remote control.



- 1  (mode): Selects the Teletext mode (LIST/FLOF). If pressed during LIST mode, switches the mode to List save mode. In List save mode, you can save a Teletext page into a list using the  (store) button.
- 2  (Full TTX/Double TTX/Mix/Off): Activates the Teletext mode for the current channel. Press the button twice to overlap the Teletext mode with the current broadcasting screen. Press it one more time to exit teletext.
- 3  (sub-page): Displays the available sub-page.
- 4  (store): Stores the Teletext pages.
- 5  (index): Displays the index (contents) page at any time while you are viewing Teletext.
- 6  (size): Displays the teletext on the upper half of the screen in double-size. To move the text to the lower half of the screen, press it again. For normal display, press it once again.
- 7  (hold): Holds the display at the current page, in the case that there are several secondary pages that follow automatically. To undo, press it again.
- 8  (page up): Displays the next Teletext page.
- 9  (page down): Displays the previous Teletext page.
- 10  (reveal): Displays the hidden text (answers to quiz games, for example). To display the normal screen, press it again.
- 11  (cancel): Shrinks the Teletext display to overlap with the current broadcast.
- 12 Colour buttons (red, green, yellow, blue): If the FASTEXT system is used by the broadcasting company, the different topics on a Teletext page are colour-coded and can be selected by pressing the coloured buttons. Press the colour corresponding to the topic of your choice. A new colour coded page is displayed. Items can be selected in the same way. To display the previous or next page, press the corresponding coloured button.

## The Teletext pages are organised according to six categories

Part	Contents
A	Selected page number.
B	Broadcasting channel identity.
C	Current page number or search indications.
D	Date and time.
E	Text.
F	Status information. FASTEXT information.

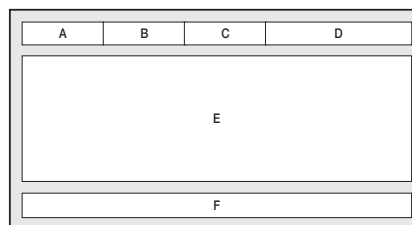



# Troubleshooting

If the TV seems to have a problem, first try this list of possible problems and solutions. If none of these troubleshooting tips apply, visit "www.samsung.com", then click on Support, or call Samsung customer service centre.

Issues	Solutions and Explanations
Picture Quality	First of all, please perform the <b>Picture Test</b> and confirm that your TV is properly displaying test image. (go to MENU - <b>Support</b> - <b>Self Diagnosis</b> - <b>Picture Test</b> ) If the test image is properly displayed, the poor picture may be caused by the source or signal.
The TV image does not look as good as it did in the store.	<ul style="list-style-type: none"> <li>If you have an analogue cable/set top box, upgrade to a digital set top box. Use HDMI or Component cables to deliver HD (high definition) picture quality.</li> <li>Cable/Satellite subscribers: Try HD stations from the channel line up.</li> <li>Aerial connection: Try HD stations after performing Auto tuning.</li> <li>Many HD channels are up scaled from SD (Standard Definition) contents.</li> <li>Adjust the Cable/Set top box video output resolution to 1080i or 720p.</li> <li>Make sure you are watching the TV at the minimum recommended distance based on the size and definition of the signal.</li> </ul>
The picture is distorted: macroblock error, small block, dots, pixelization	<ul style="list-style-type: none"> <li>Compression of video contents may cause picture distortion especially in fast moving pictures such as sports and action movies.</li> <li>Low signal level or bad quality can cause picture distortion. This is not a TV issue.</li> <li>Mobile phones used close to the TV (cca up to 1m) may cause noise in picture on analogue and digital TV.</li> </ul>
Colour is wrong or missing.	<ul style="list-style-type: none"> <li>If you're using a component connection, make sure the component cables are connected to the correct jacks. Incorrect or loose connections may cause colour problems or a blank screen.</li> </ul>
There is poor colour or brightness.	<ul style="list-style-type: none"> <li>Adjust the <b>Picture</b> options in the TV menu. (go to <b>Picture Mode / Colour / Brightness / Sharpness</b>)</li> <li>Adjust <b>Energy Saving</b> option in the TV menu. (go to MENU - <b>System</b> - <b>Eco Solution</b> - <b>Energy Saving</b>)</li> <li>Try resetting the picture to view the default picture settings. (go to MENU - <b>Picture</b> - <b>Reset Picture</b>)</li> </ul>
There is a dotted line on the edge of the screen.	<ul style="list-style-type: none"> <li>If the picture size is set to <b>Screen Fit</b>, change it to <b>16:9</b>.</li> <li>Change cable/satellite box resolution.</li> </ul>
The picture is black and white.	<ul style="list-style-type: none"> <li>If you are using an AV composite input, connect the video cable (yellow) to the Green jack of component input 1 on the TV.</li> </ul>
When changing channels, the picture freezes or is distorted or delayed.	<ul style="list-style-type: none"> <li>If connected with a cable box, please try to reset the cable box. Reconnect the AC cord and wait until the cable box reboots. It may take up to 20 minutes.</li> <li>Set the output resolution of the cable box to 1080i or 720p.</li> </ul>
Sound Quality	First of all, please perform the <b>Sound Test</b> to confirm that your TV audio is properly operating. (go to MENU - <b>Support</b> - <b>Self Diagnosis</b> - <b>Sound Test</b> ) If the audio is ok, the sound problem may be caused by the source or signal.
There is no sound or the sound is too low at maximum volume.	<ul style="list-style-type: none"> <li>Please check the volume of the device (Cable/Sat Box, DVD, Blu-ray etc) connected to your TV.</li> </ul>
The picture is good but there is no sound.	<ul style="list-style-type: none"> <li>Set the <b>Speaker Select</b> option to <b>TV Speaker</b> in the sound menu.</li> <li>If you are using an external device, make sure the audio cables are connected to the correct audio input jacks on the TV.</li> <li>If you are using an external device, check the device's audio output option (ex. you may need to change your cable box's audio option to HDMI when you have a HDMI connected to your TV).</li> <li>If you are using a DVI to HDMI cable, a separate audio cable is required.</li> <li>Reboot the connected device by reconnecting the device's power cable.</li> </ul>
The speakers are making an inappropriate noise.	<ul style="list-style-type: none"> <li>Check the cable connections. Make sure a video cable is not connected to an audio input.</li> <li>For aerial or cable connections, check the signal strength. Low signal level may cause sound distortion.</li> </ul>

Issues	Solutions and Explanations
No Picture, No Video	
The TV will not turn on.	<ul style="list-style-type: none"> <li>• Make sure the AC power cord is securely plugged in to the wall outlet and the TV.</li> <li>• Make sure the wall outlet is working.</li> <li>• Try pressing the <b>POWER</b> button on the TV to make sure the problem is not the remote. If the TV turns on, refer to "The remote control does not work" below.</li> </ul>
The TV turns off automatically.	<ul style="list-style-type: none"> <li>• Ensure the <b>Sleep Timer</b> is set to <b>Off</b> in the <b>Time</b> menu.</li> <li>• If your PC is connected to the TV, check your PC power settings.</li> <li>• Make sure the AC power cord is plugged in securely to the wall outlet and the TV.</li> <li>• When watching TV from an aerial or cable connection, the TV will turn off after 10 ~ 15 minutes if there is no signal.</li> </ul>
There is no picture/video.	<ul style="list-style-type: none"> <li>• Check cable connections (remove and reconnect all cables connected to the TV and external devices).</li> <li>• Set your external device's (Cable/Set top Box, DVD, Blu-ray etc) video outputs to match the connections to the TV input. For example, if an external device's output is HDMI, it should be connected to an HDMI input on the TV.</li> <li>• Make sure your connected devices are powered on.</li> <li>• Be sure to select the TV's correct source by pressing the <b>SOURCE</b> button on the remote control.</li> <li>• Reboot the connected device by reconnecting the device's power cable.</li> </ul>
Aerial (Air/Cable) Connection	
The TV is not receiving all channels.	<ul style="list-style-type: none"> <li>• Make sure the Aerial cable is connected securely.</li> <li>• Please try <b>Setup</b> (Initial setup) to add available channels to the channel list. Go to <b>MENU - System - Setup</b> (Initial setup) and wait for all available channels to be stored.</li> <li>• Verify the Aerial is positioned correctly.</li> </ul>
The picture is distorted: macro block error small block, dots, pixelization	<ul style="list-style-type: none"> <li>• Compression of video contents may cause picture distortion, especially on fast moving pictures such as sports and action movies.</li> <li>• A low signal can cause picture distortion. This is not a TV issue.</li> </ul>
Others	
The picture will not display in full screen.	<ul style="list-style-type: none"> <li>• HD channels will have black bars on either side of the screen when displaying up scaled SD (4:3) contents.</li> <li>• Black bars on the top and bottom will appear during movies that have aspect ratios different from your TV.</li> <li>• Adjust the picture size options on your external device or TV to full screen.</li> </ul>
The remote control does not work.	<ul style="list-style-type: none"> <li>• Replace the remote control batteries with the poles (+/-) in the right direction.</li> <li>• Clean the sensor's transmission window on the remote.</li> <li>• Try pointing the remote directly at the TV from 1.5 ~ 1.8m away.</li> </ul>
The cable/set top box remote control doesn't turn the TV on or off, or adjust the volume.	<ul style="list-style-type: none"> <li>• Programme the Cable/Set top box remote control to operate the TV. Refer to the Cable/Set top box user manual for the SAMSUNG TV code.</li> </ul>
A " <b>Mode Not Supported</b> " message appears.	<ul style="list-style-type: none"> <li>• Check the supported resolution of the TV, and adjust the external device's output resolution accordingly.</li> </ul>
There is a plastic smell from the TV.	<ul style="list-style-type: none"> <li>• This smell is normal and will dissipate over time.</li> </ul>
The TV <b>Signal Information</b> is unavailable in the <b>Self Diagnosis</b> Test menu.	<ul style="list-style-type: none"> <li>• This function is only available with digital channels from an Aerial / RF / Coax connection.</li> </ul>
TV is tilted to the right or left side.	<ul style="list-style-type: none"> <li>• Remove the stand base from the TV and reassemble it.</li> </ul>
There are difficulties assembling the stand base.	<ul style="list-style-type: none"> <li>• Make sure the TV is placed on a flat surface. If you cannot remove the screws from the TV, please use a magnetized screw driver.</li> </ul>

Issues	Solutions and Explanations
The <b>Broadcasting</b> menu is grey out (unavailable).	<ul style="list-style-type: none"> <li>The <b>Broadcasting</b> menu is only available when the TV source is selected.</li> </ul>
Your settings are lost after 5 minutes or every time the TV is turned off.	<ul style="list-style-type: none"> <li>If the TV is in the <b>Store Demo</b> mode, it will reset audio and picture settings every 5 minutes. If you want to change the settings from <b>Store Demo</b> mode to <b>Home Use</b>, press the <b>SOURCE</b> button to select <b>TV</b> mode, and go to <b>MENU</b> → <b>Support</b> → <b>Use Mode</b>.</li> </ul>
You have intermittent loss of audio or video.	<ul style="list-style-type: none"> <li>Check the cable connections and reconnect them.</li> <li>Loss of audio or video can be caused by using overly rigid or thick cables. Make sure the cables are flexible enough for long term use. If mounting the TV to the wall, we recommend using cables with 90 degree connectors.</li> </ul>
You see small particles when you look closely at the edge of the frame of the TV.	<ul style="list-style-type: none"> <li>This is part of the product's design and is not a defect.</li> </ul>
The <b>PIP</b> menu is not available.	<ul style="list-style-type: none"> <li><b>PIP</b> functionality is only available when you are using a HDMI or components source.</li> </ul>
You turned the TV off 45 minutes ago, and it turned on again.	<ul style="list-style-type: none"> <li>It is normal. The TV operates the OTA (Over The Aerial) function itself to upgrade firmware downloaded whilst your watching TV.</li> </ul>
The message " <b>Scrambled Signal</b> " or " <b>Weak or No Signal</b> " appears.	<ul style="list-style-type: none"> <li>If you are using a CAM CARD (CI/CI+), check that it is installed into the common interface slot.</li> <li>If there is still a problem, pull the CAM CARD out of the TV and insert it into the slot again.</li> </ul>
There are recurrent picture/sound issues.	<ul style="list-style-type: none"> <li>Check and change the signal/source.</li> </ul>
A reaction may occur between the rubber cushion pads on the base stand and the top finish of some furniture.	<ul style="list-style-type: none"> <li>To prevent this, use felt pads on any surface of the TV that comes in direct contact with furniture.</li> </ul>
The message " <b>This file may not be playable properly.</b> " appears.	<ul style="list-style-type: none"> <li>This may appear because of high bit rate of content. Content generally will play but could experience some playability issue.</li> </ul>

-  You can keep your TV in optimum operating condition by upgrading to the latest firmware ([www.samsung.com](http://www.samsung.com) → support) by USB.
-  This TFT LED panel uses a panel consisting of sub pixels which require sophisticated technology to produce. However, there may be a few bright or dark pixels on the screen. These pixels will have no impact on the performance of the product.
-  Some functions and pictures shown in this manual are available on specific models only.

# Installing the Wall Mount

The wall mount kit (sold separately) allows you to mount the TV on the wall. For detailed information on installing the wall mount, see the instructions provided with the wall mount. Contact a technician for assistance when installing the wall mount bracket. We do not advise you to do it yourself.

Samsung Electronics is not responsible for any damage to the product or injury to yourself or others if you select to install the TV on your own.

## Wall Mount Kit Specifications (VESA)

✎ Wall mount kit is not supplied but sold separately.

✎ Install your wall mount on a solid wall perpendicular to the floor. When attaching to other building materials, please contact your nearest dealer. If installed on a ceiling or slanted wall, it may fall and result in severe personal injury.

### NOTE

- Standard dimensions for wall mount kits are shown in the table below.
- When purchasing our wall mount kit, a detailed installation manual and all parts necessary for assembly are provided.
- Do not use screws that do not comply with the VESA standard screw specifications.
- Do not use screws longer than the standard dimension, as they may cause damage to the inside of the TV set.
- For wall mounts that do not comply with the VESA standard screw specifications, the length of the screws may differ depending on their specifications.
- Do not fasten the screws too strongly, this may damage the product or cause the product to fall, leading to personal injury. Samsung is not liable for these kinds of accidents.
- Samsung is not liable for product damage or personal injury when a non-VESA or non-specified wall mount is used or the consumer fails to follow the product installation instructions.
- Do not exceed 15 degrees tilt when mounting this TV.

inches	VESA Spec. (A * B)	Standard Screw	Quantity
58	400 X 400	M8	4

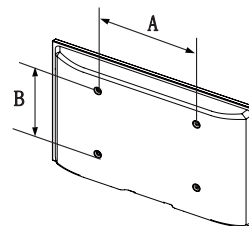

Do not install your Wall Mount Kit while your TV is turned on. It may result in personal injury due to electric shock.

# Securing the TV to the Wall



**Caution:** Pulling, pushing, or climbing on the TV may cause the TV to fall. In particular, ensure your children do not hang on or destabilize the TV. Doing so may cause the TV to tip over, causing serious injuries or death. Follow all safety precautions provided in the Safety Flyer included with your TV. For added stability and safety, you can purchase and install the anti-fall device as described below.

## To avoid the TV from falling

1. Put the screws into the clamps and firmly fasten them onto the wall. Confirm that the screws have been firmly installed onto the wall.
  - You may need additional material such as an anchor depending on the type of wall.
  - Since the necessary clamps, screws, and string are not supplied, please purchase these additionally.
2. Remove the screws from the centre back of the TV, put the screws into the clamps, and then fasten the screws onto the TV again.
  - Screw Specifications
    - For a 58 inches: M8
3. Connect the clamps fixed onto the TV and the clamps fixed onto the wall with a strong string and then tie the string tightly.
  - **NOTE**
    - Install the TV near to the wall so that it does not fall backwards.
    - It is safe to connect the string so that the clamps fixed on the wall are equal to or lower than the clamps fixed on the TV.
    - Untie the string before moving the TV.
4. Verify all connections are properly secured. Periodically check connections for any sign of fatigue for failure. If you have any doubt about the security of your connections, contact a professional installer.

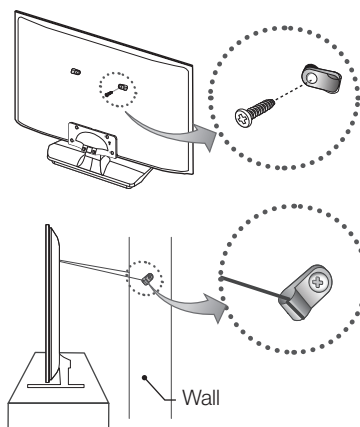

- The product colour and shape may vary depending on the model.

## Securing the Installation Space

Keep the required distances between the product and other objects (e.g. walls) to ensure proper ventilation.

Failing to do so may result in fire or a problem with the product due to an increase in the internal temperature of the product.

- When using a stand or wall-mount, use parts provided by Samsung Electronics only.
  - If you use parts provided by another manufacturer, it may result in a problem with the product or an injury due to the product falling.
- The appearance may differ depending on the product.
- Be careful when you contact the TV because some parts can be somewhat hot.

Installation with a stand.

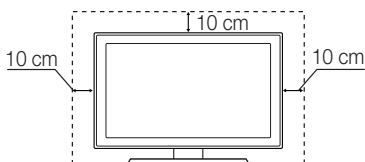

Installation with a wall-mount.

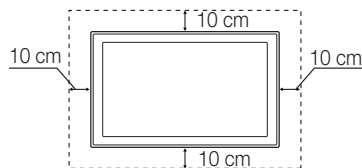

## Storage and Maintenance

- If you remove the attached sticker on the TV screen, clean the residues and then watch TV.
- The exterior and screen of the product can get scratched during cleaning. Be sure to wipe the exterior and screen carefully using a soft cloth to prevent scratches.

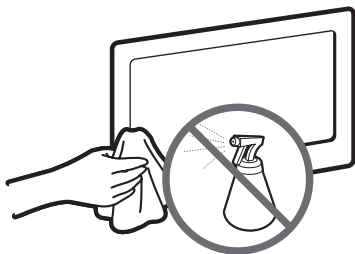

Do not spray water directly onto the product. Any liquid that goes into the product may cause a failure, fire, or electric shock.

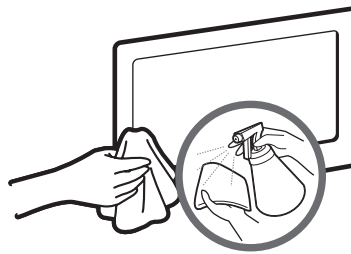



Clean the product with a soft cloth dampened with a small amount of water. Do not use a flammable liquid (e.g. benzene, thinners) or a cleaning agent.

---

## Anti-theft Kensington Lock

The Kensington Lock is not supplied by Samsung. It is a device used to physically fix the system when using it in a public place. The appearance and locking method may differ from the illustration depending on the manufacturer. Refer to the manual provided with the Kensington Lock for additional information on proper use.

- ✎ Please find a “” icon on the rear of the TV. A Kensington slot is beside the “” icon.
- ✎ The position and colour may differ depending on the model.

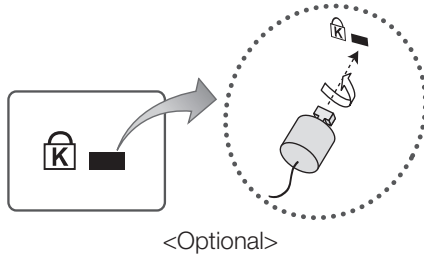

To lock the product, follow these steps:

1. Wrap the Kensington lock cable around a large, stationary object such as desk or chair.
2. Slide the end of the cable with the lock attached through the looped end of the Kensington lock cable.
3. Insert the locking device into the Kensington slot on the product.
4. Lock the lock.

- ✎ These are general instructions. For exact instructions, see the User manual supplied with the locking device.
- ✎ The locking device has to be purchased separately.



# Specifications

Environmental Considerations	
Operating Temperature	10°C to 40°C (50°F to 104°F)
Operating Humidity	10% to 80%, non-condensing
Storage Temperature	-20°C to 45°C (-4°F to 113°F)
Storage Humidity	5% to 95%, non-condensing
Sound (Output)	10 W X 2
Model Name	UA58H5200
Display Resolution	1920 X 1080
Screen Size	146 cm
Dimensions (W x H x D)	
Body	130.8 X 77.0 X 9.1 cm
With stand	130.8 X 84.3 X 29.5 cm
Weight	
Without Stand	17.2 kg
With Stand	21.4 kg

- 🔗 Design and specifications are subject to change without prior notice.
- 🔗 For information about power supply, and more about power consumption, refer to the label attached to the product.

# Supported Video Formats

File Extension	Container	Video Codec	Resolution	Frame rate (fps)	Bit rate (Mbps)	Audio Codec
*.avi / *.mkv *.asf / *.wmv *.mp4 / *.3gp *.vro / *.mpg *.mpeg / *.ts *.tp / *.trp *.mov / *.flv *.vob / *.svi *.divx	AVI	DivX 3.11/4.x/5.x/6.x	1920 x 1080	6 ~ 30	30	Dolby Digital LPCM ADPCM (IMA, MS) AAC HE-AAC WMA Dolby Digital Plus MPEG (MP3) DTS (Core) G.711(A-Law, μ-Law)
	MKV	MPEG4 SP/ASP				
	ASF	H.264 BP/MP/HP	640 x 480		8	
	MP4	Motion JPEG	1920 x 1080		30	
	3GP	Window Media Video v9				
	MOV	MPEG2				
	FLV	MPEG1				
	VRO					
	VOB					
	PS					
TS						

## Other Restrictions

- Video content will not play, or not play correctly, if there is an error in the content or the container.
- Sound or video may not work if the contents have a standard bit rate/frame rate above the compatible Frame/sec listed in the table.
- If the Index Table is in error, the Seek (Jump) function is not supported.
- Some USB/digital camera devices may not be compatible with the player.
- The menu can be displayed late if the video is over 10Mbps(bit rate).

Video decoder	Audio decoder
<ul style="list-style-type: none"> <li>• Supports up to H.264, Level 4.1 (FMO/ASO/RS are not supported.)</li> <li>• frame rate: <ul style="list-style-type: none"> <li>– Below 1280 x 720: 60 frame max</li> <li>– Above 1280 x 720: 30 frame max</li> </ul> </li> <li>• VC1 AP L4 is not supported.</li> <li>• GMC 2 or higher is not supported.</li> </ul>	<ul style="list-style-type: none"> <li>• WMA 10 Pro supports up to 5.1 channel and M2 profile.</li> <li>• WMA lossless audio is not supported.</li> <li>• Vorbis supports up to 2ch.</li> <li>• Dolby Digital Plus supports up to 5.1 channel.</li> </ul>

## Supported Subtitle Formats

### External

Name	File extension
MPEG-4 timed text	.txt
SAMI	.smi
SubRip	.srt
SubViewer	.sub
Micro DVD	.sub or .txt
SubStation Alpha	.ssa
Advanced SubStation Alpha	.ass
Powerdivx	.psb

### Internal

Name	Container	Format
Xsub	AVI	Picture Format
SubStation Alpha	MKV	Text Format
Advanced SubStation Alpha	MKV	Text Format
SubRip	MKV	Text Format
MPEG-4 Timed text	MP4	Text Format

## Supported Photo Formats

File Extension	Type	Resolution
*.jpg *.jpeg	JPEG	15360 X 8640
*.bmp	BMP	4096 X 4096
*.mpo	MPO	15360 X 8640

 The MPO type file does not support Zoom, Rotate and Slide Show Effect functions.

## Supported Music Formats

File Extension	Type	Codec	Remark
*.mp3	MPEG	MPEG1 Audio Layer 3	
*.m4a *.mpa *.aac	MPEG4	AAC	
*.flac	FLAC	FLAC	Supports up to 2ch.
*.ogg	OGG	Vorbis	Supports up to 2ch.
*.wma	WMA	WMA	WMA 10 Pro supports up to 5.1 channel and M2 profile. (WMA lossless audio is not supported.)
*.wav	wav	wav	
*.mid *.midi	midi	midi	type 0 and type 1

## Full available resolution

Optimal resolution for 5 series: 1920 x 1080@60Hz.

See specification page for full available resolution.

Mode	Resolution	Horizontal Frequency (KHz)	Vertical Frequency (Hz)	Pixel Clock Frequency (MHz)	Sync Polarity (H / V)	1366 x 768	1920 X 1080
IBM	720 x 400	31.469	70.087	28.322	-/+	✓	✓
MAC	640 x 480	35.000	66.667	30.240	-/-	✓	✓
	832 x 624	49.726	74.551	57.284	-/-	✓	✓
	1152 x 870	68.681	75.062	100.000	-/-		✓
VESA DMT	640 x 480	31.469	59.940	25.175	-/-	✓	✓
	640 x 480	37.861	72.809	31.500	-/-	✓	✓
	640 x 480	37.500	75.000	31.500	-/-	✓	✓
	800 x 600	37.879	60.317	40.000	+/+	✓	✓
	800 x 600	48.077	72.188	50.000	+/+	✓	✓
	800 x 600	46.875	75.000	49.500	+/+	✓	✓
	1024 x 768	48.363	60.004	65.000	-/-	✓	✓
	1024 x 768	56.476	70.069	75.000	-/-	✓	✓
	1024 x 768	60.023	75.029	78.750	+/+	✓	✓
	1152 x 864	67.500	75.000	108.000	+/+		✓
	1280 x 720	45.000	60.000	74.250	+/+	✓	✓
	1280 x 800	49.702	59.810	83.500	-/+		✓
	1280 x 1024	63.981	60.020	108.000	+/+		✓
	1280 x 1024	79.976	75.025	135.000	+/+		✓
	1366 x 768	47.712	59.790	85.500	+/+	✓	✓
	1440 x 900	55.935	59.887	106.500	-/+		✓
1600 x 900RB	60.000	60.000	108.000	+/+		✓	
1680 x 1050	65.290	59.954	146.250	-/+		✓	
1920 x 1080	67.500	60.000	148.500	+/+		✓	

### NOTE

- The interlace mode is not supported.
- The set might operate abnormally if a non-standard video format is selected.

# Licence



Manufactured under license from Dolby Laboratories. Dolby and the double-D symbol are trademarks of Dolby Laboratories.



Manufactured under a license from U.S. Patent No's: 5,956,674, 5,974,380, 5,978,762, 6,487,535, 6,226,616, 7,212,872, 7,003,467, 7,272,567, 7,668,723, 7,392,195, 7,930,184, 7,333,929 and 7,548,853. DTS, the Symbol, and DTS and the Symbol together are registered trademarks & DTS Premium Sound | 5.1 is a trademark of DTS, Inc. ©2012 DTS, Inc. All Rights Reserved.



Manufactured under a license from U.S. Patent No's: 6,285,767, 8,027,477, 5,319,713, 5,333,201, 5,638,452, 5,771,295, 5,970,152, 5,912,976, 7,200,236, 7,492,907, 8,050,434, 7,720,240, 7,031,474, 7,907,736 and 7,764,802. DTS, the Symbol, and DTS and the Symbol together are registered trademarks & DTS Studio Sound is a trademark of DTS, Inc. ©2012 DTS, Inc. All Rights Reserved.



The terms HDMI and HDMI High-Definition Multimedia Interface, and the HDMI Logo are trademarks or registered trademarks of HDMI Licensing LLC in the United States and other countries.



DivX Certified® to play DivX® video up to HD 1080p, including premium content.

ABOUT DIVX VIDEO: DivX® is a digital video format created by DivX, LLC, a subsidiary of Rovi Corporation. This is an official DivX Certified® device that has passed rigorous testing to verify that it plays DivX video. Visit [divx.com](http://divx.com) for more information and software tools to convert your files into DivX videos.

ABOUT DIVX VIDEO-ON-DEMAND: This DivX Certified® device must be registered in order to play purchased DivX Video-on-Demand (VOD) movies. To obtain your registration code, locate the DivX VOD section in your device setup menu. Go to [vod.divx.com](http://vod.divx.com) for more information on how to complete your registration.

DivX®, DivX Certified® and associated logos are trademarks of Rovi Corporation or its subsidiaries and are used under license.

Covered by one or more of the following U.S. patents: 7,295,673; 7,460,668; 7,515,710; 7,519,274

## Open Source Licence Notice

Open Source used in this product can be found on the following webpage. (<http://opensource.samsung.com>)

Open Source Licence Notice is written only English.

## Recommendation - Jordan Only



Hereby, Samsung Electronics, declares that this equipment is in compliance with the essential requirements and other relevant provisions of Directive 1999/5/EC.

The original Declaration of Conformity may be found at <http://www.samsung.com>, go to Support > Search Product Support and enter the model name.

This equipment may be operated in Jordan.

## Still image warning

Avoid displaying still images (such as jpeg picture files), still image elements (such as TV channel logos, stock or news bars at the screen bottom etc.), or programmes in panorama or 4:3 image format on the screen. Constantly displaying still pictures can cause image burn-in on the LED screen, which will affect image quality. To reduce risk of this effect, please follow the recommendations below:

- Avoid displaying the same TV channel for long periods.
- Always try to display any image in full screen. Use the TV set's picture format menu for the best possible match.
- Reduce brightness and contrast to avoid the appearance of after-images.
- Use all TV features designed to reduce image retention and screen burn. Refer to the e-Manual for details.

### For India only

This product is RoHS compliant.



This marking on the product, accessories or literature indicates that the product and its electronic accessories should not be disposed of with other household waste at the end of their working life. To prevent possible harm to the environment or human health from uncontrolled waste disposal, please separate these items from other types of waste and recycle them responsibly to promote the sustainable reuse of material resources.

For more information on safe disposal and recycling visit our website [www.samsung.com/in](http://www.samsung.com/in) or contact our Helpline numbers -18002668282, 180030008282.