

(5303) ▶ P.5

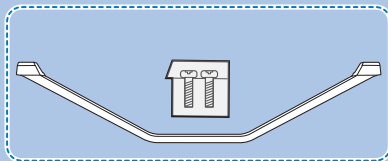

(5603) ▶ P.3

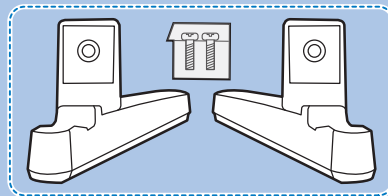

(EU)

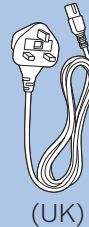

(UK)



Register your product and get support at  
[www.philips.com/welcome](http://www.philips.com/welcome)

5303 series  
5603 series

**PHILIPS**



**English** – Read the safety instructions.

**Български** - Прочетете инструкциите за безопасност.

**Čeština** – Přečtěte si bezpečnostní pokyny.

**Hrvatski** – Pročitajte sigurnosne upute.

**Dansk** – Læs sikkerhedsforskrifterne.

**Deutsch** – Lesen Sie die Sicherheitshinweise.

**Ελληνικά** - Διαβάστε τις οδηγίες ασφαλείας.

**Eesti** – Lugege ohutusnõudeid.

**Español** – Lea las instrucciones de seguridad.

**Français** – Lisez les consignes de sécurité.

**Gaeilge** – Léigh na treoracha sábháilteachta.

**Bahasa Indonesia** – Baca petunjuk keselamatan.

**Italiano** – Leggere le istruzioni di sicurezza.

**Қазақша** - Қорғаныстық нұсқаулар.

**Latviešu** – Izlasiet drošības norādījumus.

**Lietuvių** – Perskaitykite saugos instrukcijas.

**Македонски** – Прочитајте ги безбедносните инструкции.

**Magyar** – Olvassa el a biztonsági utasításokat.

**Bahasa Malaysia** – Baca arahan keselamatan.

**Nederlands** – Lees de veiligheidsvoorschriften.

**Norsk** – Les sikkerhetsforskriftene.

**Polski** – Zapoznaj się z instrukcjami bezpieczeństwa.

**Português** – Leia as instruções de segurança.

**Română** – Citiți instrucțiunile de siguranță.

**Русский** – Ознакомьтесь с инструкцией по технике безопасности.

**Shqip** – Lexo udhëzimet e sigurisë.

**Srpski** – Pročitajte bezbednosna uputstva.

**Slovenščina** – Preberite varnostna navodila.

**Slovensky** – Prečítajte si bezpečnostné pokyny.

**Suomi** – Lue turvaohjeet.

**Svenska** – Läs säkerhetsinstruktionerna.

**ภาษาไทย** โปรดอ่านคำแนะนำด้านความปลอดภัย

**Türkçe** – Güvenlik talimatlarını okuyun.

**Українська** – Читайте інструкції з техніки безпеки.

**Кыргызча** – Коопсуздук техникасы боюнча нускаманы окуңуз.

**Tiếng Việt** – Hãy đọc chỉ dẫn an toàn.

**简体中文** – 请阅读安全说明。

**繁體中文** – 請閱讀安全說明。

**العربية** قراءة تعليمات السلامة.

**עברית** קראו את הוראות הבטיחות



5603

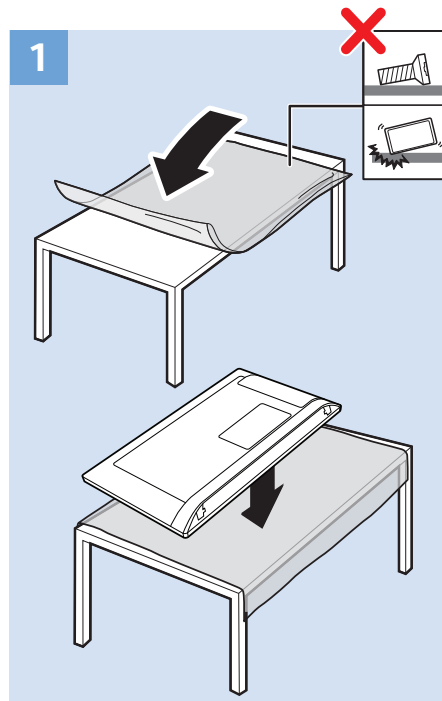
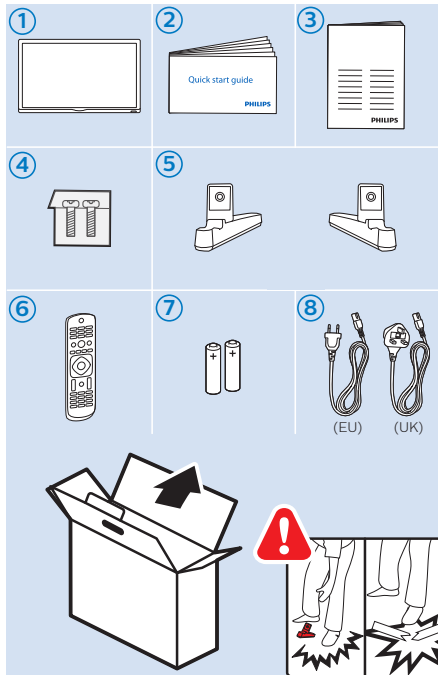

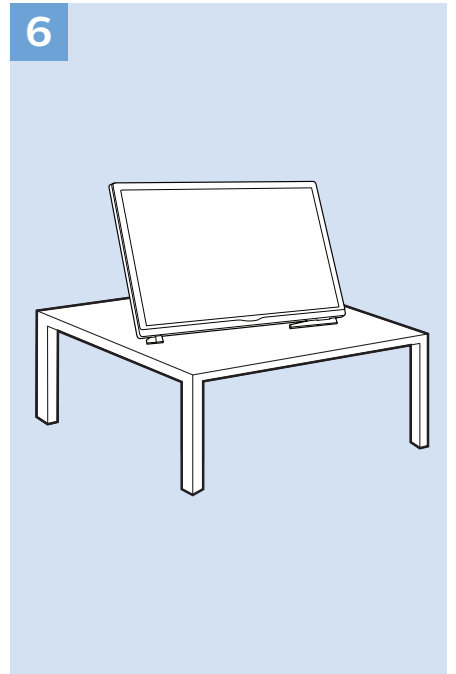
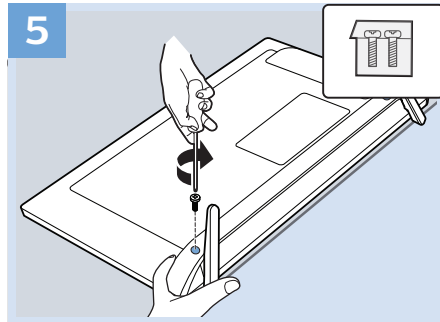
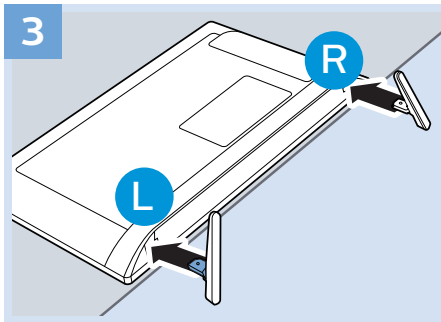
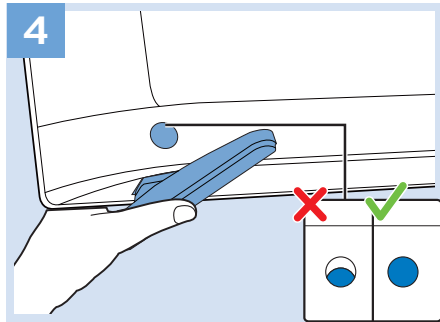
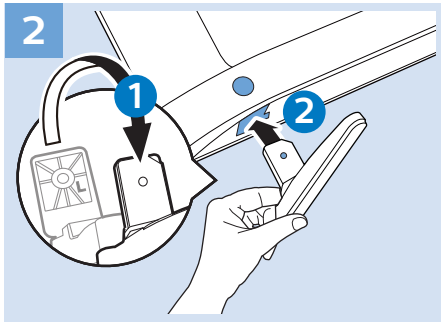



5303

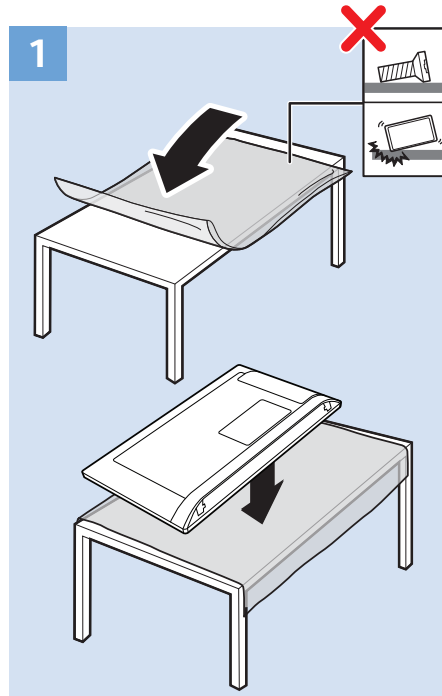
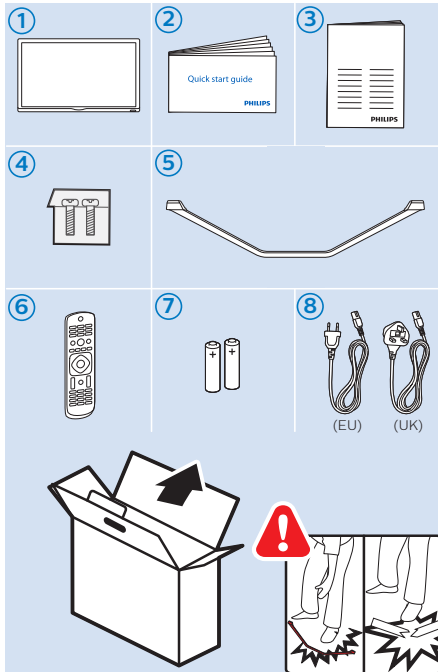

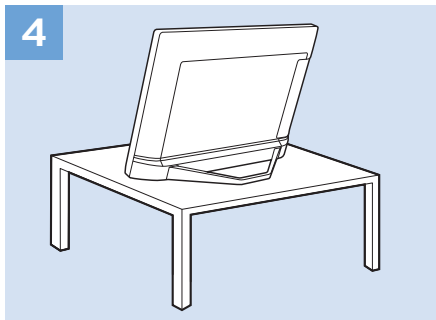
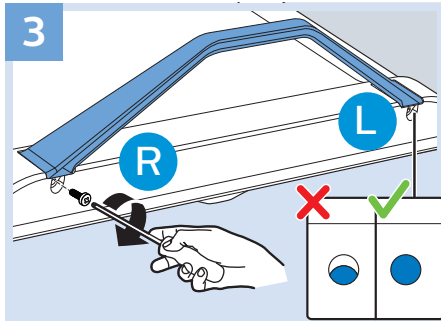
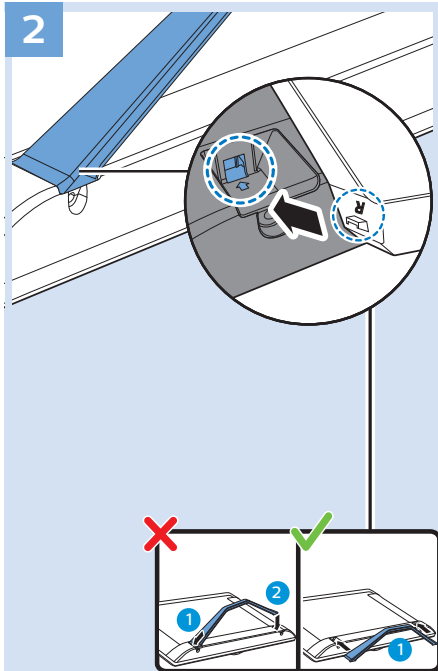

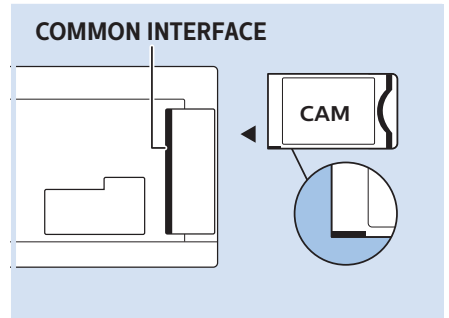
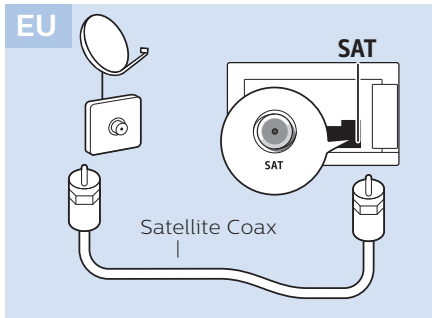
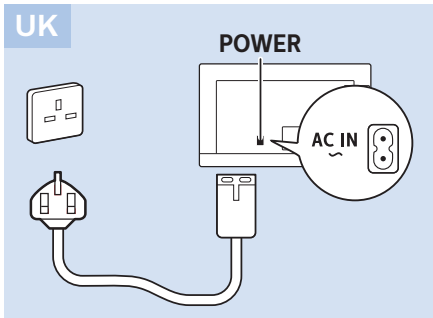
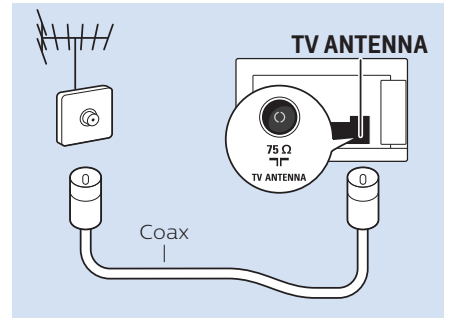
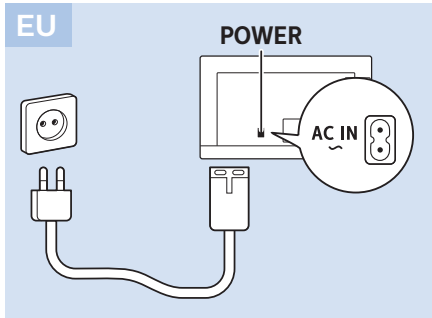
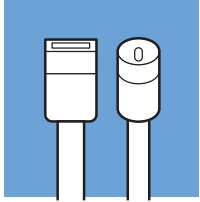

### Blu ray - HDMI

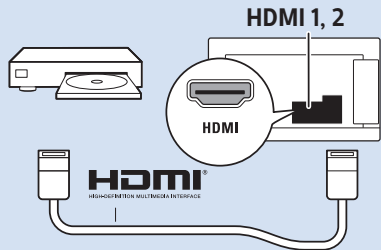

### Computer - VGA

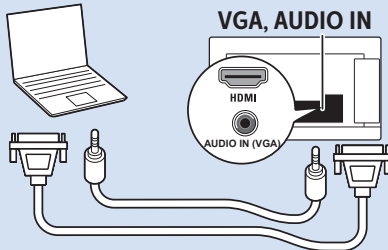

### Computer - DVI

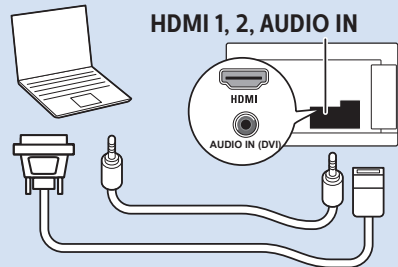

### Computer - HDMI

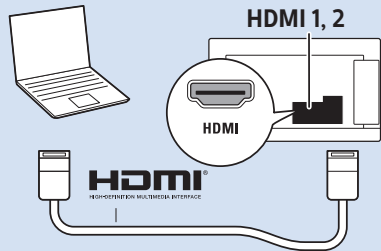

### USB Flash Drive

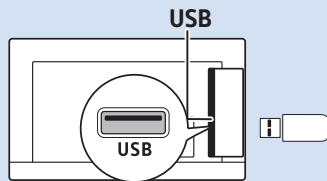

### USB Hard Drive

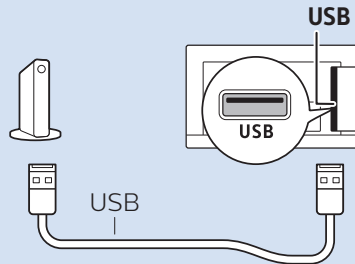



## Digital Audio System - OPTICAL

### DIGITAL AUDIO OUT - OPTICAL

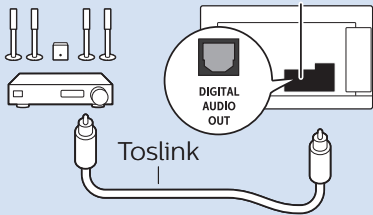

## DVD Player - SCART

### SCART

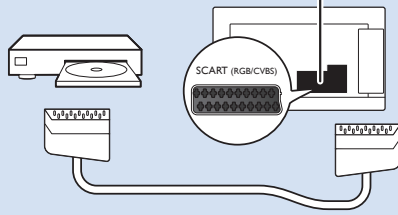

## Headphones

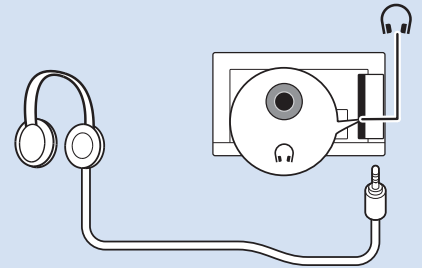

## Digital Audio System - HDMI ARC

### HDMI 1 ARC

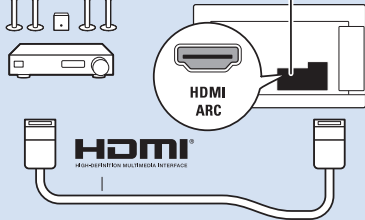

## Wired Network - Freeview

UK

### NETWORK

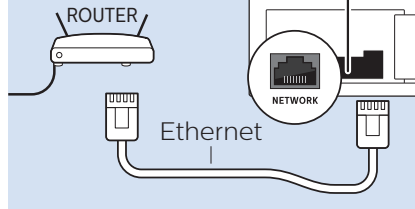

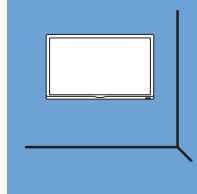
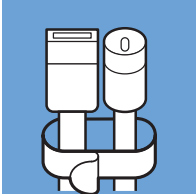

VESA (x, y)  
22" (55 cm) 75x75 M4  
24" (60 cm) 75x75 M4

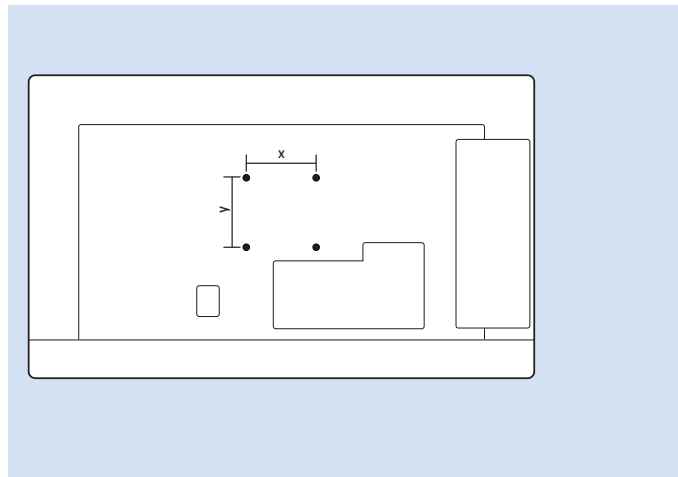
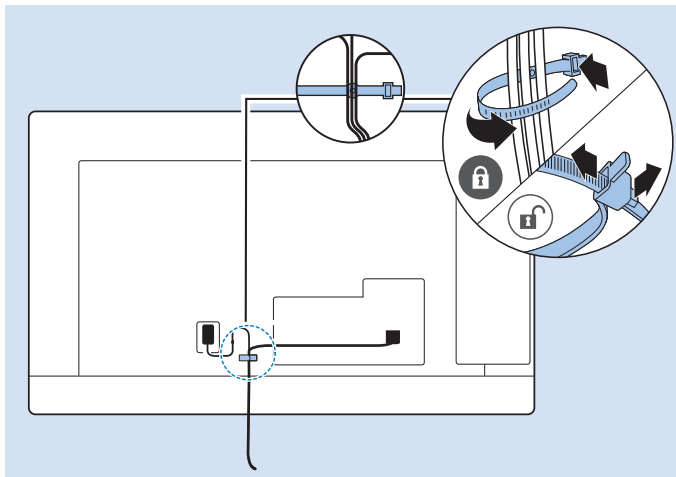

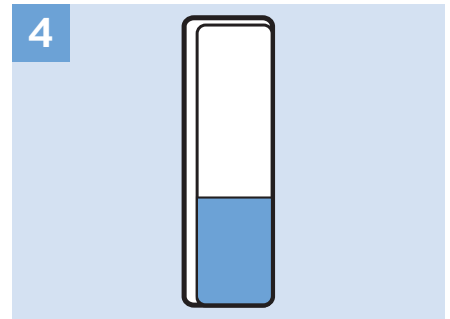
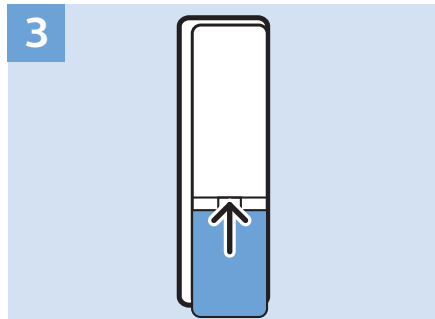
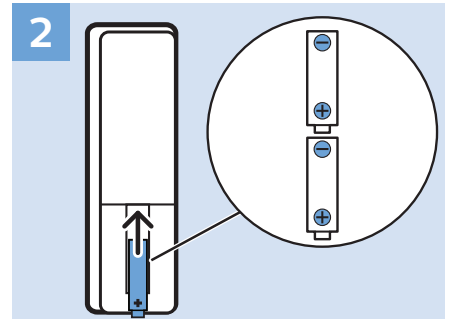
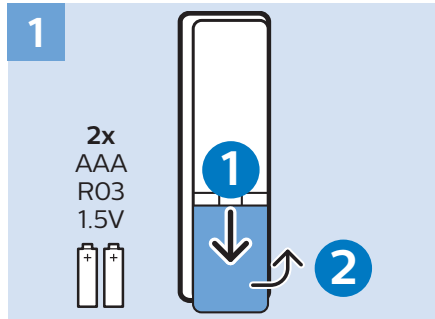
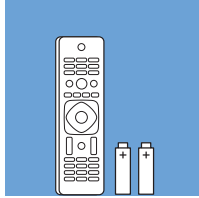

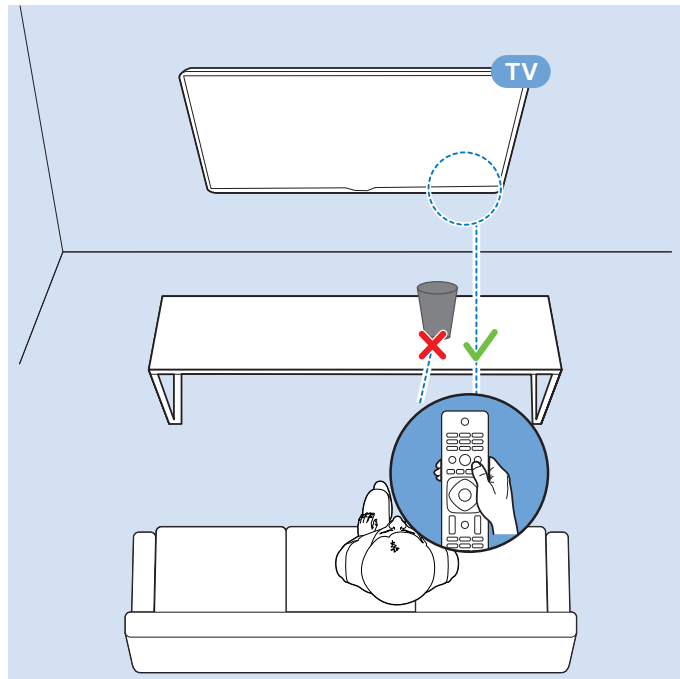
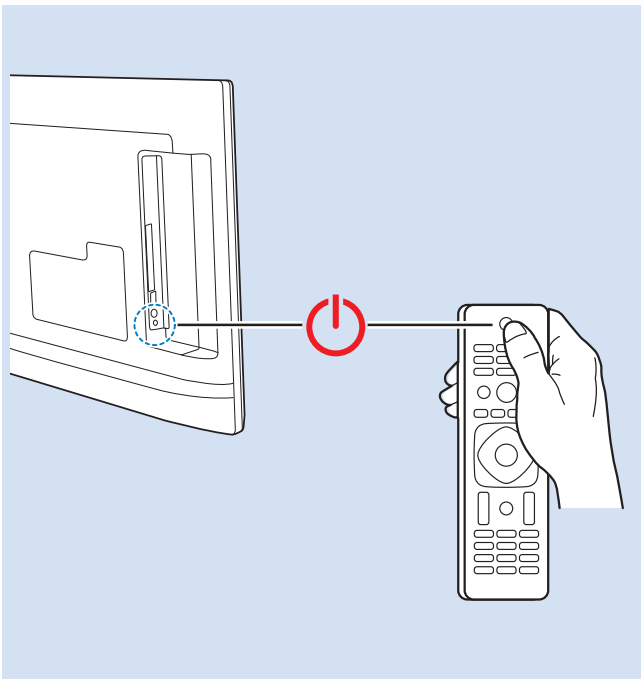

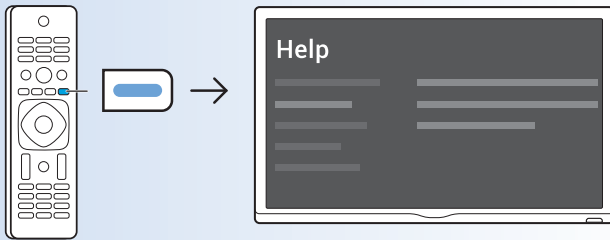

[www.philips.com/TVsupport](http://www.philips.com/TVsupport)

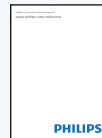







All registered and unregistered trademarks are property of their respective owners.  
Specifications are subject to change without notice.  
Philips and the Philips' shield emblem are trademarks of Koninklijke Philips N.V.  
and are used under license from Koninklijke Philips N.V.  
2018 © TP Vision Europe B.V. All rights reserved.

[philips.com](https://www.philips.com)