

User Manual

65OLED973

PHILIPS

Contents

1 What's new	4
1.1 Home and channels	4
1.2 Apps and Philips TV Collection	4
2 Setting Up	5
2.1 Read Safety	5
2.2 TV Stand and Wall Mounting	5
2.3 Tips on Placement	5
2.4 Power Cable	5
2.5 Antenna Cable	6
3 Remote Control	7
3.1 Key overview	7
3.2 Key overview (Easy Remote)	8
3.3 IR Sensor	9
3.4 Batteries	9
3.5 Batteries (Easy Remote)	9
3.6 Cleaning	9
4 Switching On and Off	11
4.1 On or Standby	11
4.2 Keys on TV	11
5 Channels	12
5.1 Install Channels	12
5.2 Channel Lists	12
5.3 Channel List sorting	12
5.4 Watching channels	13
5.5 Favourite Channels	15
5.6 Text / Teletext	16
5.7 Interactive TV	17
6 Channel Installation	19
6.1 Satellite Installation	19
6.2 Antenna Installation	22
6.3 Channel List Copy	24
7 Connect Devices	26
7.1 About Connections	26
7.2 CAM with Smart Card - CI+	27
7.3 Home Theatre System - HTS	28
7.4 Smartphones and Tablets	28
7.5 Blu-ray Disc Player	28
7.6 DVD Player	28
7.7 Bluetooth	29
7.8 Headphones	29
7.9 Game Console	30
7.10 USB Hard Drive	30
7.11 USB Keyboard	31
7.12 USB Flash Drive	31
7.13 Photo Camera	32
7.14 Camcorder	32
7.15 Computer	32
8 Connect your Android TV	33
8.1 Network and Internet	33
8.2 Google Account	35
8.3 Home Screen	35
8.4 Philips TV Collection App	36
9 Apps	37
9.1 About Apps	37
9.2 Google Play	37
9.3 Start or Stop an App	38
9.4 Lock Apps	38
9.5 Manage Apps	39
9.6 Storage	40
10 Internet	41
10.1 Start Internet	41
10.2 Options on Internet	41
11 TV Menu	42
11.1 About TV Menu	42
11.2 Open TV Menu	42
12 Sources	43
12.1 Switch to a device	43
12.2 Options for a TV Input	43
12.3 Device Name and Type	43
12.4 Rescan Connections	43
13 Networks	45
13.1 Network	45
13.2 Bluetooth	45
14 Settings	46
14.1 Picture	46
14.2 Sound	50
14.3 Ambilight Settings	51
14.4 Eco Settings	53
14.5 General Settings	53
14.6 Clock, Region, and Language Settings	55
14.7 Android Settings	56
14.8 Universal Access Settings	56
14.9 Lock Settings	57
15 Videos, Photos and Music	58
15.1 From a Computer or NAS	58
15.2 Favourites Menu	58
15.3 Most Popular Menu and Last Played Menu	58
15.4 From a USB Connection	58
15.5 Play your Videos	58
15.6 View your Photos	59
15.7 Play your Music	61
16 TV Guide	62
16.1 What You Need	62
16.2 TV Guide Data	62
16.3 Using the TV Guide	62
17 Recording and Pause TV	64
17.1 Recording	64
17.2 Pause TV	65
18 Smartphones and Tablets	67
18.1 Philips TV Remote App	67
18.2 Google Cast	67
18.3 AirPlay	67
18.4 MHL	67
19 Games	68
19.1 What You Need	68
19.2 Gamepads	68
19.3 Play a Game	68
20 Ambilight	69
20.1 Ambilight Style	69
20.2 Ambilight Off	69
20.3 Ambilight Settings	69
20.4 Lounge Light Mode	70
21 Top Picks	71

21.1	About Top Picks	71
21.2	Now on TV	71
21.3	TV on Demand	71
21.4	Video on Demand	72
22	Netflix	73
23	Alexa	74
23.1	About Alexa	74
23.2	Using Alexa	74
24	Software	75
24.1	Update Software	75
24.2	Software Version	75
24.3	Automatic Software Update	75
24.4	Open Source Software	76
24.5	Open Source License	76
24.6	Announcements	76
25	Specifications	77
25.1	Environmental	77
25.2	Power	77
25.3	Operating System	77
25.4	Reception	77
25.5	Display Type	78
25.6	Display Input Resolution	78
25.7	Connectivity	78
25.8	Dimensions and Weights	78
25.9	Sound	78
25.10	Multimedia	78
26	Help and Support	80
26.1	Register your TV	80
26.2	Using Help	80
26.3	Troubleshooting	80
26.4	Online Help	83
26.5	Support and Repair	83
27	Safety and Care	84
27.1	Safety	84
27.2	Screen Care	85
28	Terms of Use	86
28.1	Terms of Use - TV	86
28.2	Terms of Use - Smart TV	86
28.3	Terms of Use - Philips TV Collection	86
29	Copyrights	87
29.1	MHL	87
29.2	HDMI	87
29.3	Dolby Audio	87
29.4	DTS-HD Premium Sound™	87
29.5	Wi-Fi Alliance	87
29.6	Kensington	87
29.7	Other Trademarks	87
30	Disclaimer regarding services and/or software offered by third parties	89
Index		90

What's new

Home and channels

The new Home launcher

Press  HOME on your remote control to get your new Android Home screen. From here you can decide what to watch by browsing entertainment options from app and live TV. Your Home has channels to let you discover great contents from your favourite apps. You can also add additional channels or find new apps to get more contents.

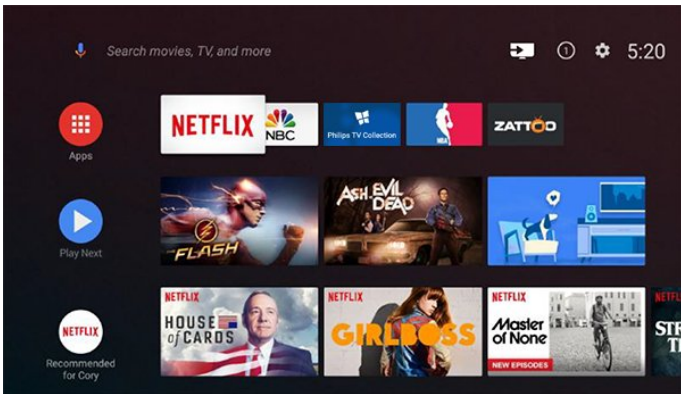

“Play Next” channel

You can always know what to watch next from **Play Next** channel on the Home screen. Start watching from where you left off and get notifications about new episodes in the **Play Next** channel. Press and hold **Select** on a movie or TV show to add it directly to the **Play Next** channel.

Accessing settings from Home

You can access **All Settings** menu via the icon at the top right corner. You can also find the **Frequent settings** menu and common menu items in the Philips TV Menu, which can be invoked directly from the remote control.

System bar on Home screen

The System bar on the top of Home screen contains following features.

- Search button: to trigger Google search with voice or text input.
- Input source: to launch the input source list and switch to any of the connected devices.
- Notifications: to provide you the messages about your Smart TV system.
- Settings: to access all setting menu and adjust the TV settings.
- Clock: to indicate the system clock.

Apps and Philips TV Collection

Favourite Apps on the first row

You can find more apps in the Apps page which can be opened by clicking the Apps icon at the left end of the Favourite apps row. You can also add more apps as favourite from the Apps page.

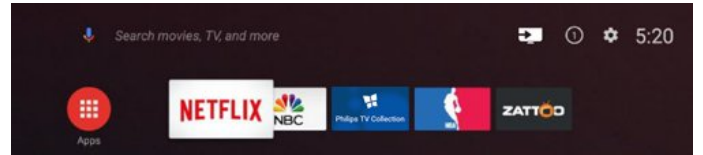

Philips TV Collection

All your premium apps are available within the Philips TV Collection app. Launch it using the banner on the Favourite apps row. The Philips TV Collection app will also contain recommendations for new Apps and more.

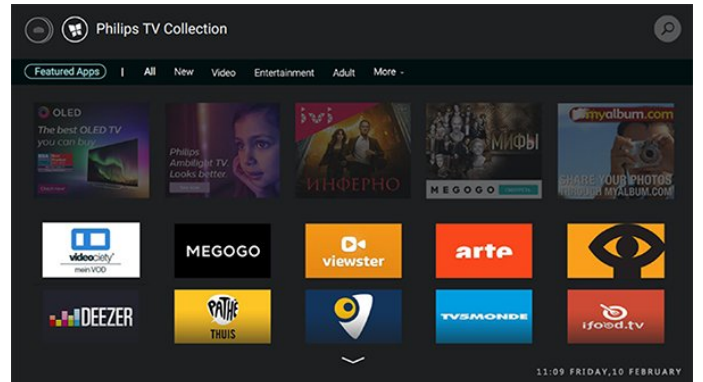

Setting Up

2.1

Read Safety

Read the safety instructions first before you use the TV.

To read the instructions, in **Help**, press the colour key **Red** **Keywords** and look up **Safety Instructions**.

2.2

TV Stand and Wall Mounting

TV Stand

You can find the instructions for mounting the TV stand in the Quick Start Guide that came with the TV. In case you lost this guide, you can download it from www.philips.com.

Use the product type number of the TV to look for the **Quick Start Guide** to download.

Wall Mounting

Your TV is also prepared for a VESA-compliant wall mount bracket (sold separately).

Use the following VESA code when purchasing the wall mount . . .

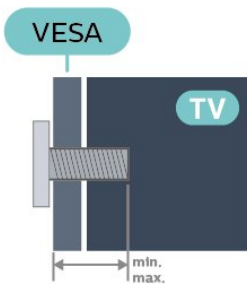

• 65OLED973

VESA MIS-F 300x200, M6 (min.: 15mm, max.:18mm)

Preparation

First remove the 4 plastic screw caps out of the threaded bushes on the back of the TV.

Make sure that the metal screws, to mount the TV to the VESA-compliant bracket, go about 10mm deep inside the threaded bushes of the TV.

Caution

Wall mounting the TV requires special skills and should only be performed by qualified personnel. The TV wall mounting should meet safety standards

according to the TV's weight. Also read the safety precautions before positioning the TV. TP Vision Europe B.V. bears no responsibility for improper mounting or any mounting that results in accident or injury.

2.3

Tips on Placement

- Position the TV where light does not shine directly on the screen.
- Dim lighting conditions in the room for best Ambilight effect.
- The ideal distance to watch TV is 3 times its diagonal screen size. When seated, your eyes should be level with the centre of the screen.
- When wall mounted, position the TV up to 15 cm away from the wall.

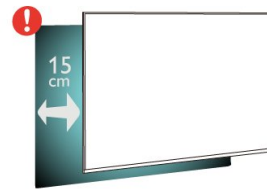

Note:

Please keep the TV away from dust-producing sources such as stoves. It is suggested to clean the dust regularly to avoid getting dust into the TV.

2.4

Power Cable

- Insert the power cable into the **POWER** connector on the back of the TV.
- Make sure the power cable is securely inserted in the connector.
- Make sure that the power plug, in the wall socket, is accessible at all times.
- When you unplug the power cable, always pull the plug, never pull the cable.

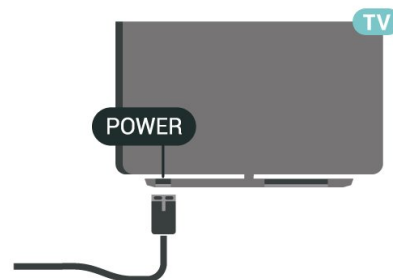

Although this TV has a very low standby power consumption, unplug the power cable to save energy if you do not use the TV for a long period of time.

For more information, in **Help**, press the colour

key **—** Keywords and look up **Switching On** for more information on switching the TV on or off.

2.5

Antenna Cable

Insert the antenna plug firmly into the **Antenna** socket at the back of the TV.

You can connect your own antenna or an antenna signal from an antenna distribution system. Use an IEC Coax 75 Ohm RF antenna connector.

Use this antenna connection for DVB-T and DVB-C input signals.

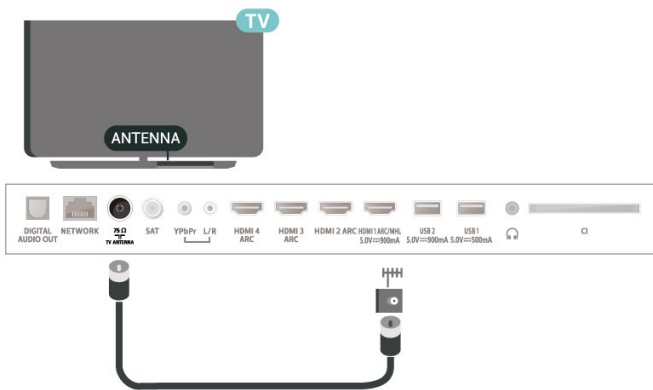

Remote Control

3.1

Key overview

Top

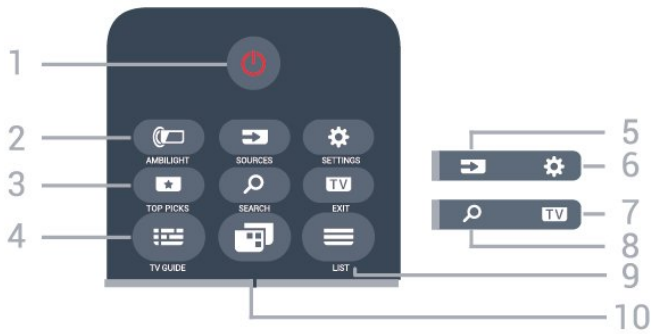

- 1 - Standby / On
To switch the TV on or back to Standby.
- 2 - AMBILIGHT
To select one of the Ambilight style.
- 3 - TOP PICKS
To open the menu with recommended programmes, Video on Demand (Rental Videos) or Online TV (Catch Up TV).
If available.
- 4 - TV GUIDE
To open or close the TV Guide.
- 5 - SOURCES
To open or close the Sources menu.
- 6 - SETTINGS
To open the Frequent Settings.
- 7 - TV EXIT
To switch back to watching TV. To leave an interactive TV application.
- 8 - SEARCH
To open the searches page.
- 9 - LIST
To open or close the channel list.
- 10 - TV Menu
To open the TV Menu with typical TV functions.

Middle

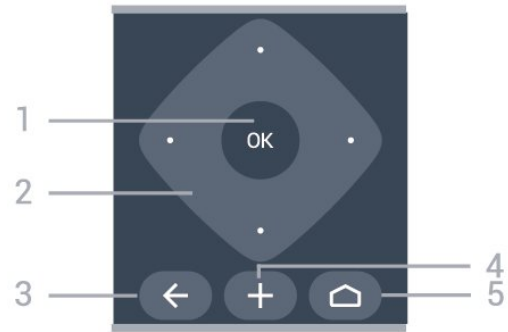

- 1 - OK key
To confirm a selection or setting.
- 2 - Arrow / navigation keys
To navigate up, down, left or right.
- 3 - BACK
To switch back to the previous channel you selected.
To return to previous menu.
To go back to the previous App/Internet page.
- 4 - OPTIONS
To open or close the Options menu.
- 5 - HOME
To open the Home menu.

Bottom



- 1 - Colour keys
Direct selection of options.
- 2 - Volume
To adjust the volume level.
- 3 - Number keys
To select a channel directly.
- 4 - SUBTITLE
To switch Subtitles on, off or on during mute.

- 5 - Playback and Record
 - Play ►, to playback.
 - Pause II, to pause playback
 - Stop ■, to stop playback
 - Rewind ◀◀, to rewind
 - Fast forward ▶▶, to go fast forward
 - Record ●, to start recording

6 - NETFLIX

To open the Netflix App directly. With the TV switched on or from standby.

7 - ≡ Channel

To switch to the next or previous channel in the channel list. To open the next or previous page in Text/Teletext. To start the next or previous chapter on a disc.

8 - 🔊 Mute

To mute the sound or to restore it.

9 - TEXT

To open or close Text/Teletext.

3.2

Key overview (Easy Remote)

Key overview

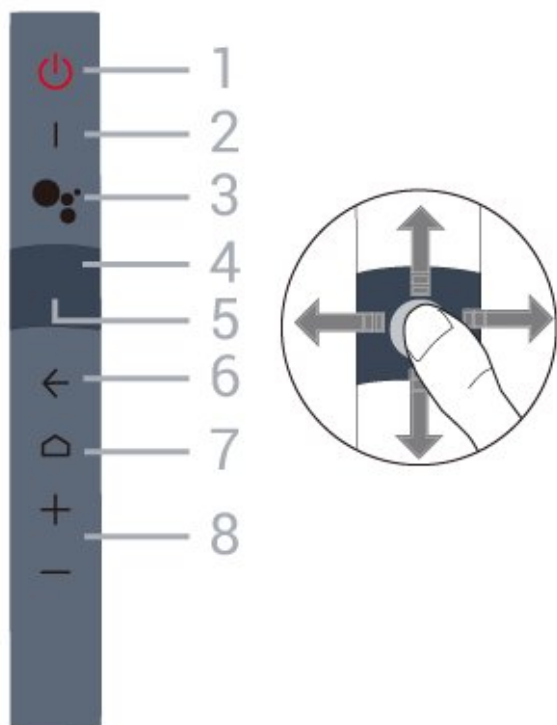

1 - ⏻ Standby / On

To switch the TV on or back to Standby.

2 - VOICE microphone

Speak near this hole during voice search.

3 - ● VOICE

To start voice search.

4 - Navigation Pad - arrow / navigation

- To navigate up, down, left or right.
- During broadcast, swipe up/down to switch channels.

5 - Navigation Pad - OK

To confirm a selection or setting.

6 - ← BACK

- To switch back to the previous channel you selected.
- To return to previous menu.

7 - 🏠 HOME

To open the Home menu.

8 - Volume

To adjust the volume level.

Other functions

Mute

Long press "-" (Volume down) to mute the sound.

TV Menu

Long press Home to open the TV menu with typical TV functions.

Switch channels

Swipe up/down in "Watch TV" mode to switch channels.

Pairing with your TV

You can simply point the remote control to TV, then press-and-hold the 🏠 HOME and ← BACK keys until remote control Blue LED starts blinking (about 3 seconds later), then release the Home and Back keys.

It is advisable to start the pairing process after the TV set has fully started-up (i.e. Android launcher is fully loaded).

Please keep the remote control close to the TV (within 1m distance) during pairing.

Alternatively, go ⚙ Settings > All settings > Wireless and network > Remote control > Pair remote control, then follow the on-screen instructions.

A message appears when the pairing is successful.

Voice search

You can search for videos, music or anything else on the Internet by simply using your voice. You can speak into the microphone on the remote control.

You need to pair the remote control to the TV before use voice search.

To use Voice...

1 - Press **VOICE** on remote control, the blue light on the remote control lights up and the search field opens, the microphone is active.

2 - Speak out what you are looking for with clear pronunciation. You can speak for 10 seconds before the microphone switches off. It might take some time for the results to appear.

3 - In the list of search results, you can select the item you want.

Set the language you like to use with voice interaction

⚙ **Settings** > **All settings** > **Android settings** > **Preferences** > **Speech**

3.3

IR Sensor

The TV can receive commands from a remote control that uses IR (infrared) to send commands. If you use such a remote control, always make sure you point the remote control at the infrared sensor on the front of the TV.

⚠ Warning

Do not put any objects in front of IR sensor of the TV, it may block the IR signal.

3.4

Batteries

If the TV does not react on a key press on the remote control, the batteries might be empty.

To replace the batteries, open the battery compartment on the front-bottom of the remote control.

1 - Slide the battery door in the direction shown by the arrow.

2 - Replace the old batteries with 2 type **AAA-R03-1.5V** batteries. Make sure the **+** and the **-** ends of the batteries line up correctly.

3 - Reposition the battery door and slide it back until it clicks.

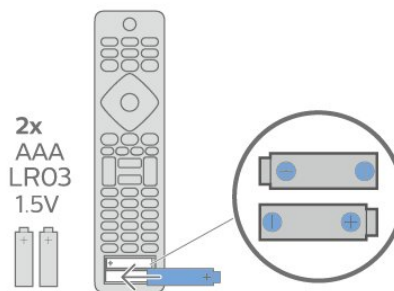

Remove the batteries if you are not using the remote control for a long time.

Safely dispose of your old batteries according to the end of use directions.

For more information, in **Help**, select **Keywords** and look up **End of use**.

3.5

Batteries (Easy Remote)

If the TV does not react on a key press on the remote control, the batteries might be empty.

To replace the batteries, open the battery compartment on the front-bottom of the remote control.

1 - Slide the battery door in the direction shown by the arrow.

2 - Replace the old batteries with 2 Alkaline, type **AAA-LR03-1.5V** batteries. Make sure the **+** and the **-** ends of the batteries line up correctly.

3 - Reposition the battery door and slide it back until it clicks.

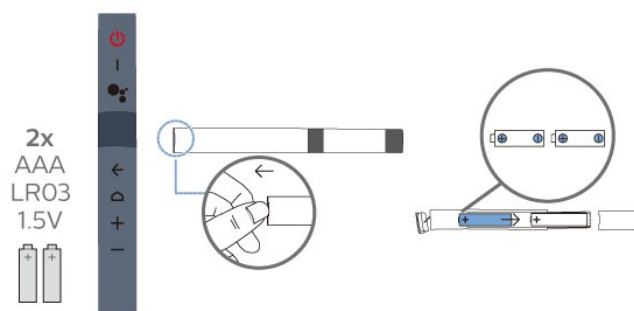

Remove the batteries if you are not using the remote control for a long time.

Safely dispose of your old batteries according to the end of use directions.

For more information, in **Help**, select **Keywords** and look up **End of use**.

Cleaning

Your remote control is treated with a scratch-resistant coating.

To clean the remote control, use a soft damp cloth. Never use substances such as alcohol, chemicals or household cleaners on the remote control.



Switching On and Off

4.1

On or Standby

Make sure the TV is connected to the mains AC power. Connect the supplied power cord to the AC in connector at the back of the TV. The indicator light at the bottom of the TV lights up.

Switch on

Press  on the remote control to switch the TV on. Alternatively, press  HOME. You can also press the small joystick key on the back of the TV to switch the TV on in case you can't find the remote control or its batteries are empty.

Switch to standby

To switch the TV to standby, press  on the remote control. You can also press the small joystick key on the back of the TV.

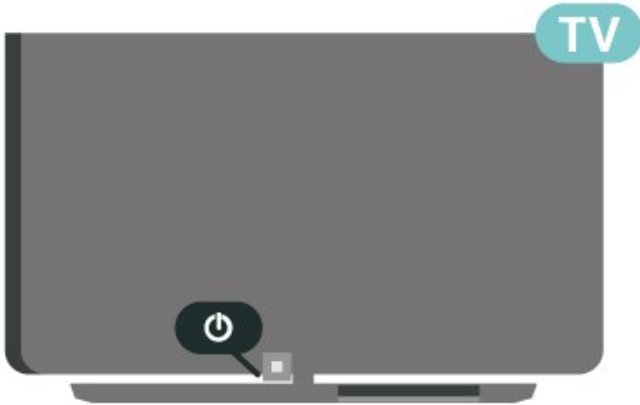

In standby mode, the TV is still connected to the mains power but consumes very little energy.

To switch off the TV completely, disconnect the power plug.





When disconnecting the power plug, always pull the power plug, never the cord. Ensure that you have full access to the power plug, power cord and outlet socket at all times.

Keys on TV

If you lost the remote control or its batteries are empty, you can still do some basic TV operations.

To open the basic menu...

1 - With the TV switched on, press the joystick key on the back of the TV to bring up the basic menu.

2 - Press left or right to select  Volume,  Channel or  Sources. Select  Demo, to start a demo movie.

3 - Press up or down to adjust the volume or tune to the next or previous channel. Press up or down to go through the list of sources, including the tuner selection. Press the joystick key to start the demo movie.

4 - The menu will disappear automatically.

To switch the TV on standby, select  and press the joystick key.



Channels

5.1

Install Channels

For more information, in **Help**, press the colour key **■** **Keywords** and look up **Channel, Antenna Installation** or **Channel, Cable Installation**.

5.2

Channel Lists

About Channel Lists

After a channel installation, all channels appear on the channel list. Channels are shown with their name and logo if this information is available.

With a channel list selected, press the arrows **▲** (up) or **▼** (down) to select a channel, then press **OK** to watch the selected channel. You only tune to the channels in that list when using **≡ +** or **≡ -** keys.

Channel icons

After an Automatic Channel Update of the channel list, newly found channels are marked with a **★** (star).
If you lock a channel, it will be marked with a **🔒** (lock).

Radio stations

If digital broadcasting is available, digital radio stations are installed during installation. Switch to a radio channel just like you switch to a TV channel. A Cable (DVB-C) channel installation usually places radio stations from channel number 1001 onwards.

This TV can receive digital television standard DVB. TV may not work properly with some operators of digital television, non-compliance with requirements of the standard in full.

Open a Channel List

Next to the list with all channels, you can select a filtered list or you can select one of the favourite lists you created.

To open the current channel list...

- 1 - Press **TV**, to switch to TV.
- 2 - Press **OK** to open the current channel list.
- 3 - Press **← BACK** to close the channel list.

To select one of the channel lists...

- 1 - With a channel list open on screen, press **+ OPTIONS**.
- 2 - Select **Select Channel List** and press **OK**.
- 3 - In the list menu, select one of the available channel lists and press **OK**.

Alternatively, you can select the list name at the top of the channel list and press **OK** to open the list menu.

Search for a Channel

You can search for a channel to find it in a long list of channels.

The TV can search for a channel within one of the 2 main channel lists - the Antenna or Cable channel list.

To search for a channel...

- 1 - Press **TV**.
- 2 - Press **OK** to open the current channel list.
- 3 - Press **+ OPTIONS**.
- 4 - Select **Select Channel List** and press **OK**.
- 5 - Select **Filter Antenna Channels** or **Filter Cable Channels** and press **OK**.
- 6 - Select **Search Channel** and press **OK** to open a text field. You can use the remote control keyboard (if available) or the on-screen keyboard to enter text.
- 7 - Enter a number, a name or part of a name and select **Apply** and press **OK**. The TV will search for matching channel names in the list you selected.

Search results are listed as a channel list - see the list name at the top. The search results disappear once you select another channel list or close the list with search results.

5.3

Channel List sorting

You can do channel list sorting with all channels. You can set the channel list to show only TV channels or only Radio stations. For Antenna/Cable channels you can set the list to show the Free-to-Air or the Scrambled channels.

To set a filter on a list with all channels...

- 1 - Press **TV**.
- 2 - Press **OK** to open the current channel list.
- 3 - Press **+ OPTIONS**.
- 4 - Select **Select Channel List** and press **OK**.
- 5 - Select **Filter Antenna Channels** or **Filter Cable Channels** according to the list you want to filter, and press **OK**.
- 6 - In the **Options** menu, select the filter you want and press **OK** to activate. The name of the filter appears as part of the channel list name on top of the channel list.

7 - Press **◀** (left) to go back one step or press **←** to close the menu.

5.4

Watching channels

Tune to a Channel

To start watching TV channels, press **TV**. The TV tunes to the channel you last watched.

Switch Channels

To switch channels, press **≡ +** or **≡ -**.
If you know the channel number, type in the number with the number keys. Press **OK** after you entered the number to switch immediately.

If the information is available from the Internet, the TV shows the current programme name and details followed by the next programme name and details.

Previous channel

To switch back to the previously tuned channel, press **← BACK**.

You can also tune to channels from a **Channel List**.

Lock a Channel

Lock and Unlock a Channel

To prevent children from watching a channel, you can lock a channel. To watch a locked channel, you must enter the 4 digit **Child Lock** PIN code first. You cannot lock programmes from connected devices.

To lock a channel...

- 1 - Press **TV**.
- 2 - Press **OK** to open the channel list. If necessary change the channel list.
- 3 - Select the channel you want to lock.
- 4 - Press **+ OPTIONS** and select **Lock Channel** and press **OK**.
- 5 - Enter your 4 digit PIN code if the TV asks for it. A locked channel is marked with a **🔒** (lock).
- 6 - Press **◀** (left) to go back one step or press **← BACK** to close the menu.

To unlock a channel...

- 1 - Press **TV**.
- 2 - Press **OK** to open the channel list. If necessary change the channel list.
- 3 - Select the channel you want to unlock.
- 4 - Press **+ OPTIONS** and select **Unlock Channel** and press **OK**.
- 5 - Enter your 4 digit PIN code if the TV asks for it.
- 6 - Press **◀** (left) to go back one step or press **← BACK** to close the menu.

If you lock or unlock channels in a channel list, you only have to enter the PIN code just once until you close the channel list.

For more information, in **Help**, press the colour key **— Keywords** and look up **Child Lock** for more information.

Parental Rating

To prevent children from watching a programme not suitable for their age, you can set an age rating.

Digital channels can have their programmes age rated. When the age rating of a programme is equal to or higher than the age you have set as age rating for your child, the programme will be locked. To watch a locked programme, you must enter the **Parental Rating** code first.

To set an age rating...

- 1 - Press **⚙️**, select **All Settings** and press **OK**.
- 2 - Select **Child Lock > Parental Rating** and press **OK**.
- 3 - Enter a 4-digit Child lock code. If you did not set a code yet, select **Set Code** in **Child Lock**. Enter a 4-digit Child lock code and confirm. Now you can set an age rating.
- 4 - Back in **Parental Rating**, select the age and press **OK**.
- 5 - Press **◀** (left) repeatedly if necessary, to close the menu.

To switch off the parental age rating, select **None**. However, in some countries you must set an age rating.

For some broadcasters/operators, the TV only locks programmes with a higher rating. The parental age rating is set for all channels.

Channel Options

Open Options

While watching a channel, you can set some options.

Depending on the type of channel you are watching (analogue or digital) or depending on the TV settings you made, some options are available.

To open the options menu...

- 1 - While watching a channel, press **+ OPTIONS**.
- 2 - Press **+ OPTIONS** again to close.

Subtitles

Switch On

Digital broadcasts can have subtitles for their programmes.

To show the subtitles...

Press **SUBTITLE**.

You can switch subtitles **On** or **Off**. Alternatively you can select **Automatic**.

Automatic

If language information is part of the digital broadcast and the broadcasted programme is not in your language (the language set on TV), the TV can show subtitles automatically in one of your preferred subtitle languages. One of these subtitle languages must also be part of the broadcast.

You can select your preferred subtitle languages in **Subtitle Language**.

Subtitles from Text

If you tune to an analogue channel, you need to make the subtitles available for each channel manually.

- 1 - Switch to a channel and press **TEXT** to open Text.
- 2 - Enter the page number for subtitles, usually **888**.
- 3 - Press **TEXT** again, to close Text.

If you select **On** in the Subtitle menu when watching this analogue channel, subtitles will be shown if available.

To know if a channel is analogue or digital, switch to the channel and open **Information** in **+ OPTIONS**.

Subtitle Language

Preferred Subtitle Languages

A digital broadcast can offer several subtitle languages for a programme. You can set a preferred primary and secondary subtitle language. If subtitles in one of these languages are available, the TV will show the subtitles you selected.

To set the primary and secondary subtitle language...

- 1 - Press **⚙️**, select **All Settings** and press **OK**.
- 2 - Select **Region and Language > Languages > Primary Subtitles** or **Secondary Subtitles**.
- 3 - Select the language you need and press **OK**.
- 4 - Press **⬅️** (left) to go back one step or press **⬅️ BACK** to close the menu.

Select a Subtitle Language

If none of the preferred subtitle languages are available, you can select another subtitle language if available. If no subtitle languages are available, you cannot select this option.

To select a subtitle language when none of your preferred languages are available...

- 1 - Press **+ OPTIONS**.
- 2 - Select **Subtitle Language** and select one of the languages as subtitles temporarily.

Audio Language

Preferred Audio Language

A digital broadcast can offer several audio languages (spoken languages) for a programme. You can set a preferred primary and secondary audio language. If audio in one of these languages is available, the TV will switch to the audio language.

To set the primary and secondary audio language...

- 1 - Press **⚙️**, select **All Settings** and press **OK**.
- 2 - Select **Region and Language** and select **Languages > Primary Audio** or **Secondary Audio**.
- 3 - Select the language you need and press **OK**.
- 4 - Press **⬅️** (left) to go back one step or press **⬅️ BACK** to close the menu.

Select an Audio Language

If none of the preferred audio languages are available, you can select another audio language if available. If no audio languages are available, you cannot select this option.

To select an audio language when none of your preferred languages are available...

- 1 - Press **+ OPTIONS**.
- 2 - Select **Audio Language** and select one of the languages as audio temporarily.

Common Interface

If you installed a CAM in one of the Common Interface slots, you can view the CAM and operator information or do some CAM related settings.

To view the CAM information...

- 1 - Press **📺 SOURCES**.
- 2 - Select the channel type you are using the CAM for **Watch TV**.
- 3 - Press **+ OPTIONS** and select **Common Interface**.

- 4 - Select the appropriate Common Interface slot and press **➤** (right).
- 5 - Select the TV operator of the CAM and press **OK**. The following screens come from the TV operator.

HbbTV on this Channel

If you want to avoid access to HbbTV pages on a specific channel, you can block the HbbTV pages for this channel only.

Switch on HbbTV

Press **⚙**, select **All Settings > General settings > Advanced > HbbTV settings > HbbTV > On**.

Programme Info

View programme details

To call up the details of the selected programme...

- 1 - Tune to the channel.
- 2 - Press **+ OPTIONS**, select **Programme Info** and press **OK**.
- 3 - To close this screen, press **OK**.

Alternatively, you can directly press **i INFO** to access the information of now and next programmes. On **Programme Info**, press the colour key **■ SCHEDULED** to enter the scheduled recording list, or repeatedly press **➤** (right) to enter the TV Guide.

Mono / Stereo

You can switch the sound of an analogue channel to Mono or Stereo.

To switch to Mono or Stereo...

- 1 - Tune to an analogue channel.
- 2 - Press **+ OPTIONS**, select **Mono/Stereo** and press **➤** (right).
- 3 - Select **Mono** or **Stereo** and press **OK**.
- 4 - Press **◀** (left) to go back one step or press **← BACK** to close the menu.

Reorder Channels

Only in a **Favourites List** you can change the sequence of channels (reorder).

To change the sequence of channels...

- 1 - Open the **Favourites List** you want to reorder.
- 2 - Press **+ OPTIONS**, select **Reorder Channels** and press **OK**.

- 3 - In the **Favourites List**, select the channel you want to reorder and press **OK**.
- 4 - With the **▲** (up) or **▼** (down) keys move the channel where you want it.
- 5 - Press **OK** to confirm the new location.
- 6 - You can reorder channels with the same method until you close the **Favourites List** with the **← BACK** key.

5.5

Favourite Channels

About Favourite Channels

In a favourite channel list, you can collect the channels you like.

You can create 4 different lists of favourite channels for easy channel zapping. You can name each **Favourites List** individually. Only in a **Favourites List** you can reorder channels.

With a **Favourites List** selected, press the arrows **▲** (up) or **▼** (down) to select a channel, then press **OK** to watch the selected channel. You only tune to the channels in that list when using **≡ +** or **≡ -** keys.

Create a Favourites List

To create a favourite channels list...

- 1 - Press **TV**, to switch to TV.
- 2 - Press **OK** to open the current channel list.
- 3 - Press **+ OPTIONS**.
- 4 - Select **Create Favourites List** and press **OK**.
- 5 - In the list at the left, select a channel you want as a favourite and press **OK**. Channels come in the list at the right in the order you add them. To undo, select the channel in the list at the left and press **OK** again.
- 6 - If necessary, you can go on selecting and adding channels as favourites.
- 7 - To finish adding channels, press **← BACK**.

The TV will ask to rename the **Favourites List**. You can use the on-screen keyboard.

- 1 - Use the on-screen keyboard to delete the current name and enter a new name.
- 2 - When done, select **Close** and press **OK**.

The TV will switch to the newly created **Favourites List**.

You can add a range of channels in one go or start a **Favourites List** by duplicating the channel list with all channels and removing the channels you do not want.

The channels in the **Favourites List** are renumbered.

Add a Range of Channels

To add a consecutive range of channels to a Favourites List in one go, you can use **Select Range**.

To add a range of channels...

- 1 - Open the Favourites List where you want to add a range of channels.
- 2 - Press **+ OPTIONS**, select **Select Range** and press **OK**.
- 3 - In the list at the left select the first channel of the range you want to add and press **OK**.
- 4 - Press **▼** (down) to select the last channel of the range you want to add. The channels are marked at the left.
- 5 - Press **OK** to add this range of channels and confirm.

You can also start creating a Favourites List from **Select Range**.

Rename a Favourites List

You can only rename a Favourites List.

To rename a Favourites List...

- 1 - Open the Favourite List you want to rename.
- 2 - Press **+ OPTIONS**, select **Rename Favourites List** and press **OK**.
- 3 - Use the on-screen keyboard to delete the current name and enter a new name.
- 4 - When done, select **Close** and press **OK**.
- 5 - Press **← BACK** to close the channel list.

Remove a Favourites List

You can only remove a Favourites List.

To remove a Favourites List...

- 1 - Open the Favourites List you want to remove.
- 2 - Press **+ OPTIONS**, select **Remove Favourites List** and press **OK**.
- 3 - Confirm to remove the list.
- 4 - Press **← BACK** to close the channel list.

Reorder Channels

Only in a Favourites List you can change the sequence of channels (reorder).

To change the sequence of channels...

- 1 - Open the Favourites List you want to reorder.
- 2 - Press **+ OPTIONS**, select **Reorder Channels** and press **OK**.
- 3 - In the Favourites List, select the channel you want to reorder and press **OK**.

4 - With the **▲** (up) or **▼** (down) keys move the channel where you want it.

5 - Press **OK** to confirm the new location.

6 - You can reorder channels with the same method until you close the Favourites List with the **← BACK** key.

Favourites List on TV Guide

You can link the TV Guide for your Favourite List.

- 1 - While watching a TV channel, press **≡ LIST > + OPTIONS > Select channel List**.
- 2 - Select a Favourites List and press **OK**.
- 3 - Press **≡ TV GUIDE** to open it.

With the TV Guide you can view a list of the current and scheduled TV programmes of your favourite channels. Along with your favourite channels, the first 3 most used channels from the broadcasters' default list will be appended after your favourite channels for your preview. You need to add these channels into your favourite list to enable its operation (refer to "TV Guide" chapter).

On each page of TV Guide, there is a "Did you know" grid inserted on your favourite channel list. The "Did you know"-channel provides useful tips to improve the way you use your TV.

5.6

Text / Teletext

Text Pages

To open Text/Teletext press **TEXT**, while you are watching TV channels.

To close Text, press **TEXT** again.

Select a Text page

To select a page . . .

- 1 - Enter the page number with the number keys.
- 2 - Use the arrow keys to navigate.
- 3 - Press a colour key to select a colour-coded subject at the bottom of the screen.

Text sub-pages

A Text page number can hold several subpages. The subpage numbers are shown on a bar next to the main page number.

To select a subpage, press **◀** or **▶**.



T.O.P. Text pages

Some broadcasters offer T.O.P. Text.

To open T.O.P. Text pages within Text, press **+ OPTIONS** and select **T.O.P. Overview**.

Favourite pages

The TV makes a list of the last 10 Text pages you opened. You can easily reopen them again in the Favourite Text pages column.

- 1 - In Text, select  (heart) in the top left corner of the screen to show the column of favourite pages.
 - 2 - Press  (down) or  (up) to select a page number and press **OK** to open the page.
- You can clear the list with the option **Clear Favourite Pages**.

Search Text





You can select a word and scan Text for all occurrences of this word.

- 1 - Open a Text page and press **OK**.
- 2 - Select a word or number with the arrow keys.
- 3 - Press **OK** again to jump immediately to the next occurrence of this word or number.
- 4 - Press **OK** again to jump to the subsequent occurrence.
- 5 - To stop searching, press  (up) until nothing is selected.

Text from a connected device

Some devices that receive TV channels can also offer Text.

To open Text from a connected device . . .

- 1 - Press  **SOURCES** select the device and press **OK**.
- 2 - While watching a channel on the device, press **+ OPTIONS**, select **Show Device Keys** and select the  key and press **OK**.
- 3 - Press  **BACK** to hide the device keys.
- 4 - To close Text, press  **BACK** again.

Digital Text (UK only)

Some digital broadcasters offer dedicated Digital Text or interactive TV on their digital TV channels. This includes normal Text using the number, colour and arrow keys to select and navigate.

To close Digital Text, press  **BACK**.

* The teletext can only be reached when the channels are installed directly on the TV's internal tuner and the set is on TV mode. If a set-top box is being used, the teletext will be unavailable via TV. In that case, the set-top box's teletext can be used instead.

Text Options

In Text/Teletext, press **+ OPTIONS** to select the following...

- **Freeze page**
To stop the automatic rotation of subpages.
- **Dual screen / Full screen**
To show the TV channel and Text alongside each other.
- **T.O.P. overview**
To open T.O.P. Text.



- **Enlarge**
To enlarge the Text page for comfortable reading.
- **Reveal**
To unhide hidden information on a page.
- **Cycle subpages**
To cycle subpages when these are available.
- **Hide/Show Favourite Pages**
To hide or show the list of favourite pages.
- **Clear Favourite Pages**
To clear the list of favourite pages.
- **Language**
To switch the group of characters that Text uses to display correctly.
- **Text 2.5**
To activate the Text 2.5 for more colours and better graphics.

Text Setup

Text language

Some digital TV broadcasters have several Text languages available.

To set your primary and secondary Text language . . .

- 1 - Press , select **All Settings** and press **OK**.
- 2 - Select **Region and Language** and press  (right) to enter the menu.
- 3 - Select **Language > Primary Text** or **Secondary Text** and press **OK**.
- 4 - Select your preferred Text languages.
- 5 - Press  (left) repeatedly if necessary, to close the menu.

Text 2.5

If available, Text 2.5 offers more colours and better graphics. Text 2.5 is activated as a standard factory setting.

To switch off Text 2.5...

- 1 - Press **TEXT**.
- 2 - With Text/Teletext open on screen, press **+ OPTIONS**.
- 3 - Select **Text 2.5 > Off** and press **OK**.
- 4 - Press  (left) repeatedly if necessary, to close the menu.

5.7

Interactive TV

About iTV

With interactive TV, some digital broadcasters combine their normal TV programme with information or entertainment pages. On some pages, you can respond to a programme or vote, do online shopping or pay for a video-on-demand programme.

HbbTV, MHEG, . . .

Broadcasters use various interactive TV systems : HbbTV (Hybrid Broadcast Broadband TV) or iTV (Interactive TV - MHEG). Interactive TV is sometimes referred to as Digital Text or Red button. But each system is distinct.

Visit the broadcaster's Internet website for more information.

What You Need

Interactive TV is only available on digital TV channels. To enjoy the full benefits of Interactive TV, you need a high-speed (broadband) Internet connection to the TV.



HbbTV

If a TV channel offers HbbTV pages, you must first switch on HbbTV in the TV settings to view the pages.

⚙ Settings > All settings > General settings > Advanced > HbbTV > On.



Use iTV

Open iTV pages

Most channels that offer HbbTV or iTV invite you to press the colour key  (red) or  key to open their interactive programme.

Navigate iTV pages

You can use the arrow and colour keys, the number keys and the  BACK key to navigate the iTV pages.

You can use the  (Play),  (Pause) and  (Stop) keys to watch videos within iTV pages.

Digital Text (UK only)

To open Digital Text, press **TEXT**. To close, press  BACK .

Close iTV pages

Most iTV pages inform you which key to use to close. To force an iTV page to close, switch to the next TV channel and press  BACK.

Channel Installation

Satellite Installation

About Installing Satellites

Up to 4 Satellites

You can install up to 4 satellites (4 LNBs) on this TV. Select the exact number of satellites you wish to install at the start of the installation. This will speed up the installation.

Unicable

You can use a Unicable system to connect the antenna dish to the TV. You can select Unicable for 1 or for 2 satellites at the start of the installation.

MDU - Multi-Dwelling-Unit

The built-in satellite tuners support MDU on the Astra satellites and for Digiturk on the Eutelsat satellite. MDU on Türksat is not supported.

Start the Installation

Make sure your satellite dish is connected correctly and is perfectly aligned before you start the installation.

To start the satellite installation...

- 1 - Press , select **All Settings** and press **OK**.
 - 2 - Select **Channels > Satellite Installation** and press **OK**. Enter your PIN code if necessary.
 - 3 - Select **Search for Satellite** and press **OK**.
 - 4 - Select **Search** and press **OK**. TV will search for satellites.
 - 5 - Select **Install** and press **OK**. The TV shows the current satellite installation setup.
- If you want to change this setup, select **Settings**.
If you don't want to change the setup, select **Search**.
Go to step 5.

6 - In **Installation System**, select the number of satellites you want to install or select one of the Unicable systems. When you select Unicable, you can choose the User Band Numbers and enter the User Band Frequencies for each tuner. In some countries, you can adjust some expert settings for each LNB in **More Settings**.

7 - The TV will search for the satellites available on the alignment of your antenna dish. This may take a few minutes. If a satellite is found, its name and reception strength are shown on screen.

8 - When the TV found the satellites you need,

select **Install**.

9 - If a satellite offers **Channel Packages**, the TV will show the available packages for that satellite. Select the package you need. Some packages offer a **Quick** or **Full** install for their available channels, select one or the other. The TV will install the satellite channels and radio stations.

10 - To store the satellite setup and installed channels and radio stations, select **Finish**.

Satellite Installation Settings

The satellite installation settings are preset according your country. These settings determine how the TV searches and installs satellites and its channels. You can always change these settings.

To change the satellite installation settings...

- 1 - Start the satellite installation.
- 2 - On the screen where you can start searching for satellites, select **Settings** and press **OK**.
- 3 - Select the number of satellites you want to install or select one of the Unicable systems. When you select Unicable, you can choose the User Band Numbers and enter the User Band Frequencies for each tuner.
- 4 - When you're done, select **Next** and press **OK**.
- 5 - On the Settings menu, press the colour key  **Done** to return to the screen to start searching for satellites.

Homing Transponder and LNB

In some countries, you can adjust the expert settings for homing transponder and each LNB. Only use or change these settings when a normal installation fails. If you have non-standard satellite equipment, you can use these settings to overrule the standard settings. Some providers might give you some transponder or LNB values which you can enter here.

Satellite CAMs

If you use a CAM – a Conditional Access Module with a smart card – to watch satellite channels, we recommend to do the satellite installation with the CAM inserted in the TV.

Most CAMs are used to descramble channels.

Newest generation CAMs (CI+ 1.3 with Operator Profile), can install all the satellite channels by themselves on your TV. The CAM will invite you to install its satellite(s) and channels. These CAMs not only install and descramble the channels but also handle regular channel updates.

Channel Packages

Satellite operators can offer channel packages that bundle free channels (free-to-air) and offer a sorting that suits a country. Some satellites offer subscription packages – a collection of channels you pay for.

If you choose a subscription package, the TV might ask you to select a Quick or Full installation.

Select **Quick** to install the channels of the package only or select **Full** to install the package and all other available channels too. We recommend a Quick installation for subscription packages. If you have additional satellites that are not part of your subscription package, we recommend a Full installation. All installed channels are put in the channels list All.

Unicable Setup

The Unicable System

You can use a Single Cable system, MDU or Unicable system to connect the antenna dish to the TV. A Single Cable system uses one cable to connect the satellite dish to all satellite tuners in its system. A Single Cable system is typically used in apartment buildings. If you use a Unicable system, the TV will ask you to assign a user band number and corresponding frequency during the installation. You can install 1 or 2 satellites with Unicable on this TV.

If you notice some missing channels after a Unicable installation, another installation might have been done at the same moment on the Unicable system. Do the installation again to install the missing channels.

User Band Number

In a Unicable system, each connected satellite tuner must be numbered (e.g. 0, 1, 2 or 3 etc.).

You can find the available user bands and their number on the Unicable switchbox. User band is sometimes shortened as UB. There are Unicable switchboxes that offer 4 or 8 user bands. If you select Unicable in the settings, the TV will ask you to assign the unique user band number for each built-in satellite tuners. A satellite tuner cannot have the same user band number as another satellite tuner in the Unicable system.

User Band Frequency

Next to the unique user band number, the built-in satellite receiver needs the frequency of the selected user band number. These frequencies are mostly shown next to the user band number on a Unicable switchbox.

Manual Channel Update

You can always start an channel update yourself.

To start a channel update manually...

- 1 - Press **⚙**, select **All Settings** and press **OK**.
- 2 - Select **Channels > Satellite Installation** and press **OK**.
- 3 - Select **Search for Channels** and press **OK**.
- 4 - Select **Update Channels** and press **OK**. The TV will start updating. The update may take a few minutes.
- 5 - Follow the instructions on screen. The update may take a few minutes.
- 6 - Select **Finish** and press **OK**.

Add a Satellite

You can add an additional satellite to your current satellite installation. The installed satellites and their channels remain untouched. Some satellite operators do not allow adding a satellite.

The additional satellite should be seen as an extra, it is not your main satellite subscription or not the main satellite of which you use its channel package. Typically, you would add a 4th satellite when you have 3 satellites already installed. If you have 4 satellites installed, you might consider removing one first to be able to add a new satellite.

Setup

If you currently have only 1 or 2 satellites installed, the current installation settings might not allow adding an extra satellite. If you need to change the installation settings, you must redo the complete satellite installation. You cannot use **Add satellite** if a change of settings is needed.

To add a satellite...

- 1 - Press **⚙**, select **All Settings** and press **OK**.
- 2 - Select **Channels > Satellite Installation** and press **OK**.
- 3 - Select **Search for satellite** and press **OK**.
- 4 - Select **Add Satellite** and press **OK**. The current satellites are shown.
- 5 - Select **Search** and press **OK**. The TV will search for new satellites.
- 6 - If the TV has found one or more satellites, select **Install** and press **OK**. The TV installs the

channels of the found satellites.
7 - Select **Finish** and press **OK** to store the channels and radio stations.

Remove a Satellite

You can remove one or more satellites from your current satellite installation. You remove the satellite and its channels. Some satellite operators do not allow removing a satellite.

To remove satellites...

- 1 - Press **⚙️**, select **All Settings** and press **OK**.
- 2 - Select **Channels > Satellite Installation** and press **OK**.
- 3 - Select **Search for satellite** and press **OK**.
- 4 - Select **Remove Satellite** and press **OK**. The current satellites are shown.
- 5 - Select a satellite and press **OK** to mark or unmark them to remove.
- 6 - Press **◀** (left) repeatedly if necessary, to close the menu.

Manual Installation

Manual Installation is intended for expert users.

You can use Manual Installation to quickly add new channels from a satellite transponder. You need to know the frequency and polarization of the transponder. The TV will install all channels of that transponder. If the transponder was installed before, all its channels - the former and the new ones - are moved to the end of the channel list All.

You cannot use Manual installation if you need to change the number of satellites. If this is needed, you have to do a complete installation with **Install Satellites**.

To install a transponder...

- 1 - Press **⚙️**, select **All Settings** and press **OK**.
- 2 - Select **Channels > Satellite Installation** and press **OK**.
- 3 - Select **Manual Installation** and press **➤** (right) to enter the menu.
- 4 - If you have more than 1 satellite installed, select **LNB** for which you want to add channels.
- 5 - Set the **Polarisation** you need. If you set the **Symbol Rate Mode** to **Manual**, you can enter the symbol rate in **Symbol Rate** manually.
- 6 - Press the arrows **▲** (up) or **▼** (down) to adjust the frequency, and select **Done**.
- 7 - Select **Search** and press **OK**. The signal strength is shown on screen.
- 8 - If you want to store the channels of a new transponder, select **Store** and press **OK**.
- 9 - Press **◀** (left) repeatedly if necessary, to close the menu.

Homing Transponder and LNB

In some countries, you can adjust the expert settings for homing transponder and each LNB. Only use or change these settings when a normal installation fails. If you have non-standard satellite equipment, you can use these settings to overrule the standard settings. Some providers might give you some transponder or LNB values which you can enter here.

LNB Power

By default, LNB Power is set to Auto.

22 kHz Tone

By default, the Tone is set to Auto.

Low LO Frequency / High LO Frequency

The local oscillator frequencies are set to standard values. Adjust the values only in case of exceptional equipment that needs different values.

Problems

The TV cannot find the satellites I want or the TV installs the same satellite twice

- Make sure that the correct number of satellites is set in Settings at the start of the installation. You can set the TV to search for One, Two or 3/4 satellites.

A dual head LNB cannot find a second satellite

- If the TV finds one satellite but cannot find a second one, turn the dish a few degrees. Align the dish to get the strongest signal on the first satellite. Check the signal strength indicator of the first satellite on screen. With the first satellite set at the strongest signal, select **Search** again to find the second satellite.
- Make sure the settings are set to Two Satellites.

Changing the installation settings did not solve my problem

- All settings, satellites and channels are only stored at the end of the installation when you finish.

All satellite channels are gone

- If you use a Unicable system, make sure you assigned two unique user band numbers for both built-in tuners in the Unicable settings. It might be that another satellite receiver in your Unicable system is using the same user band number.

Some satellite channels seem to have disappeared from the channel list

- If some channels seem to be gone or displaced, the broadcaster might have changed the transponder location of these channels. To restore the channel positions in the channel list, you can try an update of

the channel package.

I cannot remove a satellite

• Subscription packages do not allow removing a satellite. To remove the satellite, you have to do a complete installation again and select another package.

Sometimes the reception is poor

- Check if the satellite dish is solidly mounted. Strong winds can move the dish.
- Snow and rain can degrade the reception.

6.2

Antenna Installation

Update Channels

Automatic Channel Update

If you receive digital channels, you can set the TV to automatically update these channels.

Once a day, at 6 AM, the TV updates the channels and stores new channels. New channels are stored in the Channels List and are marked with a **★**. Channels without a signal are removed. The TV must be in standby to automatically update channels. You can switch off Automatic Channel Update.

To switch off the automatic update...

- 1 - Press **⚙**, select **All Settings** and press **OK**.
- 2 - Select **Channels > Antenna/Cable Installation** or **Antenna Installation** and press **OK**.
- 3 - Enter your PIN code if necessary.
- 4 - Select **Automatic Channel Update** and press **OK**.
- 5 - Select **Off** and press **OK**.
- 6 - Press **⬅** (left) to go back one step or press **⬅** BACK to close the menu.

When new channels are found or if channels are updated or removed, a message is shown at TV start up. To avoid this message to appear after every channel update, you can switch it off.

To switch off the message...

- 1 - Press **⚙**, select **All Settings** and press **OK**.
- 2 - Select **Channels > Antenna/Cable Installation** or **Antenna Installation** and press **OK**.
- 3 - Enter your PIN code if necessary.
- 4 - Select **Channel Update Message** and press **OK**.
- 5 - Select **Off** and press **OK**.
- 6 - Press **⬅** (left) to go back one step or press **⬅** BACK to close the menu.

In certain countries, the Automatic channel update is done while watching TV or on any moment when the TV is in standby.

Manual Channel Update

You can always start an channel update yourself.

To start a channel update manually...

- 1 - Press **⚙**, select **All Settings** and press **OK**.
- 2 - Select **Channels > Antenna/Cable Installation** or **Antenna Installation** and press **OK**.
- 3 - Enter your PIN code if necessary.
- 4 - Select **Search for Channels** and press **OK**.
- 5 - Select **Start** and press **OK**.
- 6 - Select **Update Digital Channels**, select **Next** and press **OK**.
- 7 - Select **Start** and press **OK** to update the digital channels. This can take a few minutes.
- 8 - Press **⬅** (left) to go back one step or press **⬅** BACK to close the menu.

Reinstall Channels

Reinstall All Channels

You can reinstall all channels and leave all other TV settings untouched.

If a PIN code is set, you will need to enter this code before you can reinstall channels.

To reinstall channels...

- 1 - Press **⚙**, select **All Settings** and press **OK**.
- 2 - Select **Channels > Antenna/Cable Installation** or **Antenna Installation** and press **OK**.
- 3 - Enter your PIN code if necessary.
- 4 - Select **Search for Channels** and press **OK**.
- 5 - Select **Start** and press **OK**.
- 6 - Select **Reinstall Channels**, select **Next** and press **OK**.
- 7 - Select the country where you are now and press **OK**.
- 8 - Select **Next** and press **OK**.
- 9 - Select the type of installation you want, **Antenna (DVB-T)** or **Cable (DVB-C)** and press **OK**.
- 8 - Select **Next** and press **OK**.
- 11 - Select the type of channels you want, **Digital and Analogue Channels** or **Only Digital Channels** and press **OK**.
- 8 - Select **Next** and press **OK**.
- 13 - Select **Start** and press **OK** to update the digital channels. This can take a few minutes.
- 14 - Press **⬅** (left) to go back one step or press **⬅** BACK to close the menu.

Reinstall TV

You can redo a full TV installation. The TV is completely reinstalled.

To redo a full TV installation...

- 1 - Press , select **All Settings** and press **OK**.
- 2 - Select **General Settings > Reinstall TV** and press **OK**.
- 3 - Enter your PIN code if necessary.
- 4 - Select **Yes** and press **OK** to confirm.
- 5 - The TV will reinstall completely. All settings will be reset and installed channels will be replaced. The installation can take a few minutes.
- 6 - Press **←** (left) to go back one step or press **← BACK** to close the menu.

DVB Settings

DVB-T or DVB-C Reception

During the channel installation, just before you search for channels, you selected Antenna (DVB-T) or Cable (DVB-C). Antenna DVB-T searches for terrestrial analogue channels and digital DVB-T/T2 channels. Cable DVB-C searches for analogue and digital channels available from a cable DVB-C operator.

DVB-C Channel Installation

For ease of use, all DVB-C settings are set to automatic.

If your DVB-C operator gave you specific DVB-C values, the network ID or network frequency, enter these values when the TV asks for them during installation.

Channel Number Conflicts

In some countries, different TV channels (broadcasters) might have the same channel number. While installing, the TV shows the list with channel number conflicts. You need to select which TV channel you want to install on a channel number with multiple TV channels.

Network Frequency Mode

If you intend to use the fast **Quick Scan** method in **Frequency Scan** to search for channels, select **Automatic**. The TV will use 1 of the predefined network frequencies (or HC - homing channel) as used by most cable operator in your country.

If you received a specific network frequency value to search for channels, select **Manual**.

Network Frequency

With the **Network Frequency Mode** set to **Manual**, you can enter the network frequency value received from your cable operator here. To enter the value, use the number keys.

Frequency Scan

Select the method of searching for channels. You can select the faster **Quick Scan** method and use the predefined settings used by most cable operator in your country.

If this results in having no channels installed or if some channels are missing, you can select the extended **Full Scan** method. This method will take more time to search for and install channels.

Frequency Step Size

The TV searches for channels in steps of **8MHz**.

If this results in having no channels installed or if some channels are missing, you can search in smaller steps of **1MHz**. Using the 1MHz steps will take more time to search for and install channels.

Digital Channels

If you know your cable operator is not offering digital channels, you can skip searching for digital channels.

Analogue Channels

If you know your cable operator is not offering analogue channels, you can skip searching for analogue channels.

Free / Scrambled

If you have a subscription and a CAM - Conditional Access Module for pay TV services, select **Free + Scrambled**. If you did not subscribe to pay TV channels or services, you can select **Free Channels Only**.

For more information, in **Help**, press the colour key  **Keywords** and look up **CAM, Conditional Access Module**.

Reception Quality

You can check the quality and signal strength of a digital channel. If you have your own antenna, you can reposition the antenna to try and improve the reception.

To check the reception quality of a digital channel...

- 1 - Tune to the channel.
- 2 - Press , select **All Settings** and press **OK**.
- 3 - Select **Channels > Antenna/Cable Installation** or **Antenna Installation** and press **OK**. Enter your PIN

code if necessary.

4 - Select **Digital: Reception Test** and press **OK**.

5 - Select **Search** and press **OK**. The digital frequency is shown for this channel.

6 - Select **Search** again and press **OK** to check the signal quality of this frequency. The test result is shown on screen. You can reposition the antenna or check the connections to possibly improve the reception.

7 - You can also change the frequency yourself. Select the frequency number one by one and use the **▲** (up) or **▼** (down) keys to change the value. Select **Search** and press **OK** to test the reception again.

8 - Press **◀** (left) repeatedly if necessary, to close the menu.

Manual Installation

Analogue TV channels can be manually installed, channel by channel.

To install analogue channels manually...

1 - Press **⚙**, select **All Settings** and press **OK**.

2 - Select **Channels > Antenna/Cable Installation** or **Antenna Installation** and press **OK**. Enter your PIN code if necessary.

3 - Select **Analogue: Manual Installation** and press **OK**.

• System

To set up the TV system, select **System**.

Select your country or the part of the world where you are now and press **OK**.

• Search Channel

To find a channel, select **Search Channel** and press **OK**. You can enter a frequency yourself to find a channel or let the TV search for a channel.

Press **▶** (right) to select **Search** and press **OK** to search for a channel automatically. The found channel is shown on screen and if the reception is poor, press **Search** again. If you want to store the channel, select **Done** and press **OK**.

• Store

You can store the channel on the current channel number or as a new channel number.

Select **Store Current Channel** or **Store as New Channel** and press **OK**. The new channel number is shown briefly.

You can redo these steps until you have found all available analogue TV channels.

6.3

Channel List Copy

Introduction

Channel List Copy is intended for dealers and expert users.

With Channel List Copy, you can copy the channels installed on one TV onto another Philips TV of the same range. With Channel List Copy, you avoid the time-consuming channel search by uploading a predefined channel list on a TV. Use a USB flash drive of minimum 1 GB.

Conditions

- Both TVs are from the same year range.
- Both TVs have the same hardware type. Check the hardware type on the TV type plate on the back of the TV.
- Both TVs have compatible software versions.

Current channel version

To check the current version of the channel list...

1 - Press **⚙**, select **All Settings** and press **OK**.

2 - Select **Channels**, select **Channel List Copy**, select **Current Version** and press **OK**.

3 - Press **OK** to close.

Current software version

To check the current version of the TV software...

1 - Press **⚙**, select **All Settings** and press **OK**.

2 - Select **Update Software** and press **▶** (right) to enter the menu.

3 - Select **Current Software Info** and press **OK**.

4 - The version, release notes and creation date are shown. Also, the Netflix ESN Number is shown if available.

5 - Press **◀** (left) repeatedly if necessary, to close the menu.

Copy a Channel List

To copy a channel list...

1 - Switch on the TV. This TV should have channels installed.

2 - Plug in a USB flash drive.

3 - Press **⚙**, select **All Settings** and press **OK**.

4 - Select **Channels > Channel List Copy** and press **OK**.

5 - Select **Copy to USB** and press **OK**. You might be asked to enter the Child Lock PIN code to copy the channel list.

6 - When copying is done, unplug the USB flash drive.

7 - Press **◀** (left) repeatedly if necessary, to close the menu.

Now you can upload the copied channel list onto another Philips TV.

Channel List Version

Check the current version of the channel list...

- 1 - Press , select **All Settings** and press **OK**.
- 2 - Select **Channels** and press **➤** (right) to enter the menu.
- 3 - Select **Channel List Copy** and select **Current Version**, then press **OK**.
- 4 - Press **◀** (left) repeatedly if necessary, to close the menu.

Upload a Channel List

To not Installed TVs

Depending on whether your TV is already installed or not, you must use a different method to upload a channel list.

To a TV that is not yet installed

- 1 - Plug in the power plug to start the installation and select language and country. You can skip the channel search. Finish the installation.
- 2 - Plug in the USB flash drive that holds the channel list of the other TV.
- 3 - To start the channel list upload, press , select **All Settings** and press **OK**.
- 4 - Select **Channels > Channel List Copy > Copy to TV** and press **OK**. Enter your PIN code if necessary.
- 5 - The TV notifies you if the channel list is copied to the TV successfully. Unplug the USB flash drive.

To Installed TVs

Depending on whether your TV is already installed or not, you must use a different method to upload a channel list.

To an already installed TV

- 1 - Verify the country setting of the TV. (To verify this setting, see chapter Reinstall All Channels. Start this procedure until you reach the country setting. Press **← BACK** to cancel the installation.)
If the country is correct continue with step 2.
If the country is not correct, you need to start a reinstallation. See chapter Reinstall All Channels and start the installation. Select the correct country and skip the channels search. Finish the installation. When done, continue with step 2.
- 2 - Plug in the USB flash drive that holds the channel list of the other TV.
- 3 - To start the channel list upload, press ,

- select **All Settings** and press **OK**.
- 4 - Select **Channels > Channel List Copy > Copy to TV** and press **OK**. Enter your PIN code if necessary.
- 5 - The TV notifies you if the channel list is copied to the TV successfully. Unplug the USB flash drive.

Connect Devices

About Connections

Connectivity Guide

Always connect a device to the TV with the highest quality connection available. Also, use good quality cables to ensure a good transfer of picture and sound.

When you connect a device, the TV recognizes its type and gives each device a correct type name. You can change the type name if you wish. If a correct type name for a device is set, the TV automatically switches to the ideal TV settings when you switch to this device in the Sources menu.

Antenna port

If you have a Set-top box (a digital receiver) or Recorder, connect the antenna cables to run the antenna signal through the Set-top box and/or Recorder first before it enters the TV. In this way, the antenna and the Set-top box can send possible additional channels to the Recorder to record.

HDMI ports

HDMI Quality

An HDMI connection has the best picture and sound quality. One HDMI cable combines video and audio signals. Use an HDMI cable for TV signal.

For best signal quality transfer, use a High speed HDMI cable and do not use an HDMI cable longer than 5 m.

If a device connected with HDMI is not working correctly, check if a different **HDMI Ultra HD** setting can solve this problem. In Help, press the colour key **— Keywords** and look up **HDMI Ultra HD**.

Copy protection

HDMI cables support HDCP 2.2 (High-bandwidth Digital Content Protection). HDCP is a copy protection signal that prevents copying content from a DVD disc or Blu-ray Disc. Also referred to as DRM (Digital Rights Management).

HDMI ARC

All of the HDMI connections on the TV have **HDMI ARC** (Audio Return Channel).

If the device, typically a Home Theatre System (HTS), also has the HDMI ARC connection, connect it to any of the HDMI connections on this TV. With the HDMI ARC connection, you do not need to connect the extra audio cable that sends the sound of the TV picture to the HTS. The HDMI ARC connection combines both signals.

You can use any HDMI connection on this TV to connect the HTS but ARC is only available for 1 device/connection at a time.

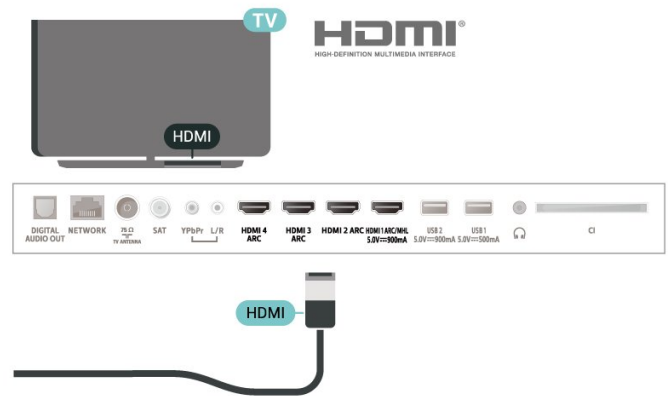

HDMI MHL

With **HDMI MHL**, you can send what you see on your Android smartphone or tablet to a TV screen.

The **HDMI 1** connection on this TV incorporates **MHL 2.0** (Mobile High-Definition Link).

This wired connection offers great stability and bandwidth, low latency, no wireless interference and good quality sound reproduction. On top of that, the MHL connection will charge the battery of your smartphone or tablet. Although connected, your mobile device will not be charging when the TV is on standby.

Inform yourself about what passive MHL cable is suited for your mobile device. In particular, with the HDMI connector for the TV on one side, the type of connector you need to connect to your smartphone or tablet.

MHL, Mobile High-Definition Link and the MHL Logo are trademarks or registered trademarks of the MHL, LLC.



HDMI CEC - EasyLink

An HDMI connection has the best picture and sound quality. One HDMI cable combines video and audio signals. Use an HDMI cable for High Definition (HD) TV signals. For best signal quality transfer, use a High speed HDMI cable and do not use an HDMI cable longer than 5 m.

Connect HDMI CEC-compatible devices to your TV, you can operate them with the TV remote control.

EasyLink HDMI CEC must be switched on on the TV and the connected device.

Switch on EasyLink

⚙ **Settings** > All settings > General settings > EasyLink > EasyLink > On.

Operate HDMI CEC-compatible devices with TV remote control

⚙ **Settings** > All settings > General settings > EasyLink > EasyLink remote control > On.

Note:

- EasyLink might not work with devices from other brands.
- The HDMI CEC functionality has different names on different brands. Some examples are: Anynet, Aquos Link, Bravia Theatre Sync, Kuro Link, Simplink and Viera Link. Not all brands are fully compatible with EasyLink. Example HDMI CEC branding names are property of their respective owners.

7.2

CAM with Smart Card - CI+

CI+

This TV is ready for the CI+ Conditional Access .

With CI+ you can watch premium HD programmes, like movies and sports, offered by digital TV operators in your region. These programmes are scrambled by the TV operator and descrambled with a prepaid CI+ module.

Digital TV operators provide a CI+ module (Conditional Access Module - CAM) and an accompanying smart card, when you subscribe to their premium programmes. These programmes have a high level of copy protection.

Contact a digital TV operator for more information on terms & conditions.



Smart Card

Digital TV operators provide a CI+ module (Conditional Access Module - CAM) and an accompanying smart card, when you subscribe to their premium programmes.

Insert the smart card into the CAM module. See the instruction you received from the operator.

To insert the CAM in the TV...

- 1 - Look on the CAM for the correct method of insertion. Incorrect insertion can damage the CAM and TV.
- 2 - While looking at the back of the TV, with the front of the CAM facing towards you, gently insert the CAM into the slot **COMMON INTERFACE**.
- 3 - Push the CAM in as far as it will go. Leave it in the slot permanently.

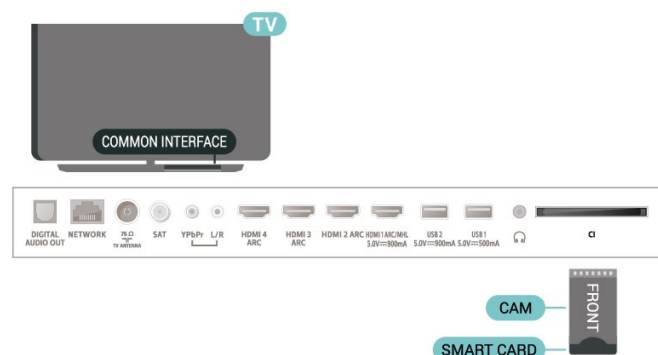

When you switch on the TV, it may take a few minutes before the CAM is activated. If a CAM is inserted and subscription fees are paid (subscription methods can differ), you can watch the scrambled channels supported by the CAM smart card.

The CAM and smart card are exclusively for your TV. If you remove the CAM, you will no longer be able to watch the scrambled channels supported by the CAM.

Passwords and PIN codes

For some CAMs, you must enter a PIN code to watch its channels. When you set the PIN code for the CAM, we recommend you to use the same code you are using to unlock the TV.

To set the PIN code for the CAM...

- 1 - Press **SOURCES**.
- 2 - Select the channel type you are using the CAM for **Watch TV**.
- 3 - Press **+ OPTIONS** and select **Common Interface**.
- 4 - Select the TV operator of the CAM. The following screens come from the TV operator. Follow the on-screen instruction to look up the PIN code setting.

7.3

Home Theatre System - HTS

Connect with HDMI ARC

Use an HDMI cable to connect a Home Theatre System (HTS) to the TV. You can connect a Philips Soundbar or an HTS with a built-in disc player.

HDMI ARC

If your Home Theatre System has an HDMI ARC connection, you can use any HDMI connection on the TV to connect. With HDMI ARC, you do not need to connect the extra audio cable. The HDMI ARC connection combines both signals.

All HDMI connections on the TV can offer the Audio Return Channel (ARC) signal. But once you have connected the Home Theatre System, the TV can only send the ARC signal to this HDMI connection.

Audio to video synchronisation (sync)

If the sound does not match the video on screen, you can set a delay on most Home Theatre Systems with a disc player to match the sound with the video.

Connect with HDMI

Use an HDMI cable to connect a Home Theatre System (HTS) to the TV. You can connect a Philips Soundbar or an HTS with a built-in disc player.

If the Home Theatre System has no HDMI ARC connection, add an optical audio cable (Toslink) to send the sound of the TV picture to the Home Theatre System.

Audio to video synchronisation (sync)

If the sound does not match the video on screen, you can set a delay on most Home Theatre Systems with

a disc player to match the sound with the video.

Problems with HTS sound

Sound with loud noise

If you watch a video from a plugged in USB flash drive or connected computer, the sound from your Home Theatre System might be distorted. This noise is heard when the audio or video file has DTS sound but the Home Theatre System has no DTS sound processing. You can fix this by setting the **Digital Out Format** of the TV to **Stereo**.

Press **⚙** for **All Settings > Sound > Advanced > Digital Out Format**.

No sound

If you cannot hear the sound from the TV on your Home Theatre System, check if you connected the HDMI cable to an **HDMI ARC** connection on the Home Theatre System. All HDMI connections on the TV are HDMI ARC connections.

7.4

Smartphones and Tablets

To connect a smartphone or tablet to the TV, you can use a wireless or wired connection.

Wireless

For a wireless connection, on your smartphone or tablet download the Philips TV Remote App from your favourite app store.

Wired

For a wired connection, use the HDMI 1 MHL connection on the back of the TV.

7.5

Blu-ray Disc Player

Use a **High speed HDMI** cable to connect the Blu-ray Disc player to the TV.

If the Blu-ray Disc player has EasyLink HDMI CEC, you can operate the player with the TV remote control.

In **Help**, press the colour key **Keywords** and look up **EasyLink HDMI CEC** for more information.

DVD Player

Use an HDMI cable to connect the DVD player to the TV.

If the DVD player is connected with HDMI and has EasyLink CEC, you can operate the player with the TV remote control.

For more information on EasyLink, in **Help**, press the colour key **Red** **Keywords** and look up **EasyLink HDMI CEC**.

Y Pb Pr - Component Video is a high quality connection.

The YPbPr connection can be used for High Definition (HD) TV signals.

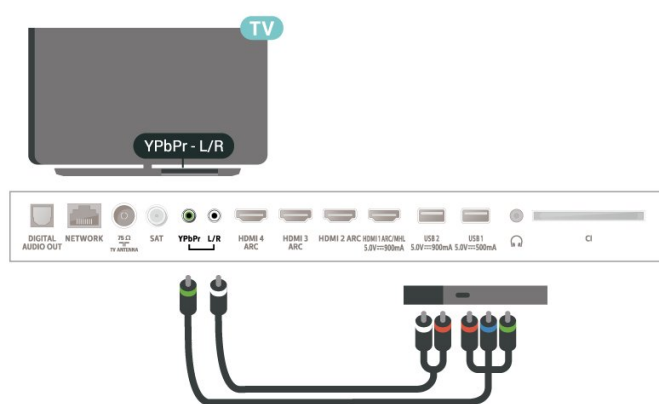

Bluetooth

Pairing a Device

Read the user manual of the device for specific information on pairing and on wireless range. Make sure the Bluetooth setting on TV is switched on.

Once a wireless gamepad is paired, you can use it. When a device is paired, you do not need to pair it again unless you remove the device.

To pair a bluetooth device with the TV...

- 1 - Switch on the bluetooth device and place it within range of the TV.
- 2 - Press **Settings**, select **All Settings** and press **OK**.
- 3 - Select **Wireless and Networks** and press **Right** (right) to enter the menu.
- 4 - Select **Bluetooth > Search Bluetooth Device**, and press **OK**.
- 5 - Select **Start** and press **OK**. Follow the instructions on screen. You will pair the device with the TV and the TV will store the connection. You might need to unpair a paired device first if the maximum

number of paired devices was reached.

6 - Select the type of device and press **OK**.

7 - Press **Left** (left) repeatedly if necessary, to close the menu.

* Your TV doesn't support Bluetooth subwoofer/speakers/headphones.

** HDMI connection is required for sound bar, speaker and other audio device.

Select a Device

To select a wireless device...

- 1 - Press **Settings**, select **All Settings** and press **OK**.
- 2 - Select **Wireless and Networks** and press **OK**.
- 3 - Select **Bluetooth > Search Bluetooth Device** and press **OK**.
- 4 - In the list, select the wireless device and press **OK**.
- 5 - Press **Left** (left) repeatedly if necessary, to close the menu.

Remove a Device

You can connect or disconnect a wireless Bluetooth device. You can also remove a wireless Bluetooth device. If you remove a Bluetooth device, the device will be unpaired.

To remove or disconnect a wireless device...

- 1 - Press **Settings**, select **All Settings** and press **OK**.
- 2 - Select **Wireless and Networks** and press **OK**.
- 3 - Select **Bluetooth > Remove Bluetooth device** and press **OK**.
- 4 - In the list, select the wireless device and press **OK**.
- 5 - Select **Disconnect or Remove** and press **OK**.
- 6 - Select **OK** and press **OK** to confirm.
- 7 - Press **Left** (left) repeatedly if necessary, to close the menu.

Headphones

You can connect a set of headphones to the **Headphone** connection on the back of the TV. The connection is a mini-jack 3.5mm. You can adjust the volume of the headphones separately.

To adjust the volume...

- 1 - Press **Settings**, select **Headphone Volume** and press **OK**.
- 2 - Press the arrows **Up** (up) or **Down** (down) to adjust the value.
- 3 - Press **Left** (left) repeatedly if necessary, to close

the menu.

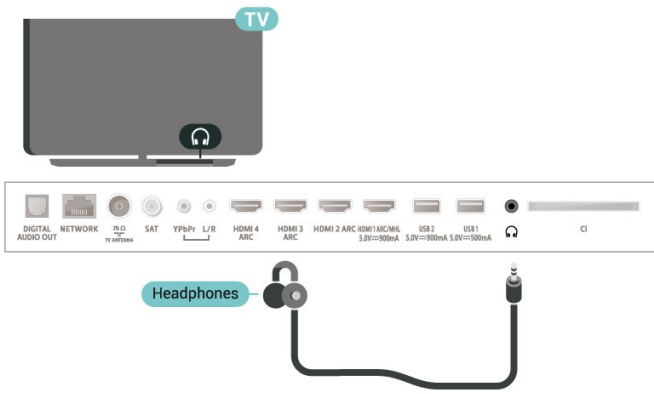

7.9

Game Console

HDMI

For best quality, connect the game console with a High speed HDMI cable to the TV.

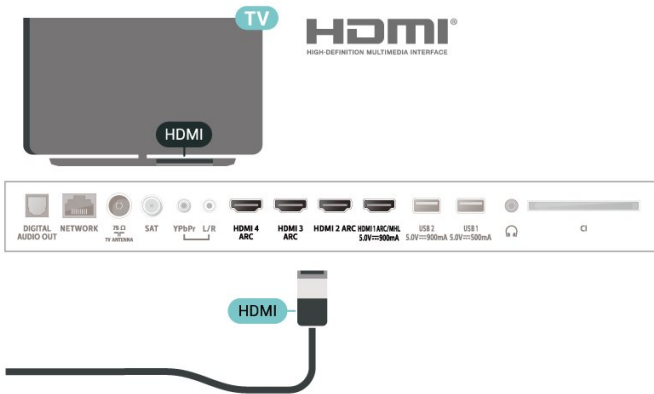

Y Pb Pr

Connect the game console with a component video cable (Y Pb Pr) and an audio L/R cable to the TV.

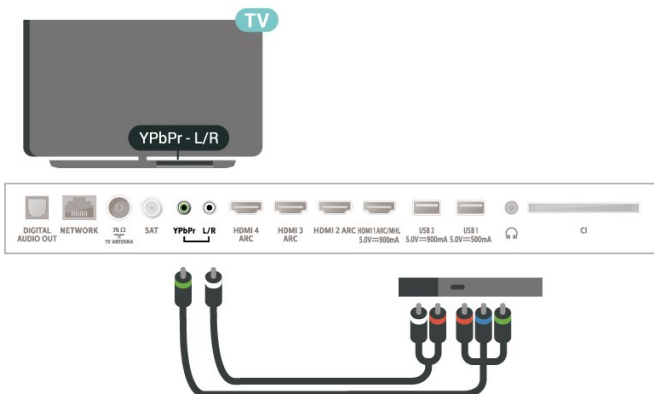

7.10

USB Hard Drive

What You Need

If you connect a USB Hard Drive, you can pause or record digital TV broadcasts (DVB broadcasts or similar).

Minimum Disk Space

- To Pause

To pause a broadcast, you need a USB 2.0 compatible Hard Drive with a minimum of 4GB disk space.

- To Record

To pause and record a broadcast, you need a minimum of 250GB disk space.

For more information on how to install a USB Hard Drive, in [Help](#), press the colour key **■** **Keywords** and look up **USB Hard Drive**, installation.

Installation

Before you can pause or record a broadcast, you must connect and format a USB Hard Drive. Formatting removes all files from the USB Hard Drive.

- 1 - Connect the USB Hard Drive to one of the **USB** connections on the TV. Do not connect another USB device to the other USB ports when formatting.
- 2 - Switch on the USB Hard Drive and the TV.
- 3 - When the TV is tuned to a digital TV channel, press **||** (Pause). Trying to pause will start the formatting.

Follow the instructions on screen.

When the USB Hard Drive is formatted, leave it connected permanently.

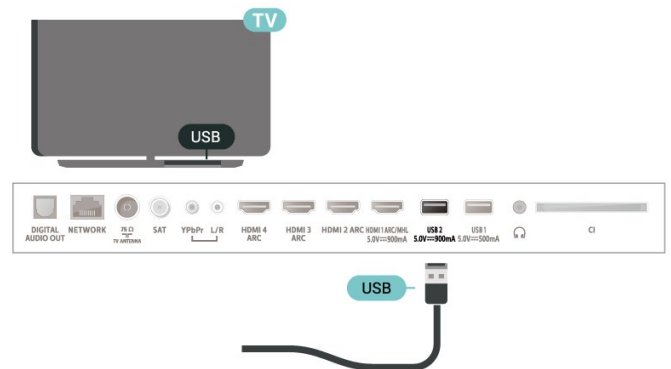

Warning

The USB Hard Drive is formatted exclusively for this TV, you cannot use the stored recordings on another

TV or PC. Do not copy or change recording files on the USB Hard Drive with any PC application. This will corrupt your recordings. When you format another USB Hard Drive, the content on the former will be lost. A USB Hard Drive installed on your TV will need reformatting for use with a computer.

Formatting

Before you can pause or record a broadcast, or store apps, you must connect and format a USB Hard Drive. Formatting removes all files from the USB Hard Drive. If you want to record broadcasts with TV Guide data from the Internet, you must setup the Internet connection first before you install the USB Hard Drive.

Warning

The USB Hard Drive is formatted exclusively for this TV, you cannot use the stored recordings on another TV or PC. Do not copy or change recording files on the USB Hard Drive with any PC application. This will corrupt your recordings. When you format another USB Hard Drive, the content on the former will be lost. A USB Hard Drive installed on your TV will need reformatting for use with a computer.

* Connect the USB Hard Drive with size less than 2TB.

To format a USB Hard Drive...

- 1 - Connect the USB Hard Drive to one of the **USB** connections on the TV. Do not connect another USB device to the other USB ports when formatting.
- 2 - Switch on the USB Hard Drive and the TV.
- 3 - Select **Recordings** if you want to perform Pause TV and Recordings, otherwise, select **Apps** to store apps. Follow the instructions on screen.
- 4 - All files and data will be removed after formatting.
- 5 - When the USB Hard Drive is formatted, leave it connected permanently.

For more information, in **Help**, press the colour key **—** **Keywords** and look up **Pause TV**, **Recording**, or **Apps**.

7.11

USB Keyboard

Connect

Connect a USB keyboard (USB-HID type) to enter text on your TV.

Use one of the **USB** connections to connect.

Configure

Install the keyboard

To install the USB keyboard, switch on the TV and connect the USB keyboard to one of the **USB** connections on the TV. When the TV detects the keyboard for the first time, you can select your keyboard lay-out and test your selection. If you select a Cyrillic or Greek keyboard layout first, you can select a secondary Latin keyboard layout.

To change the keyboard layout setting when a layout was selected...

- 1 - Press **⚙**, select **All Settings** and press **OK**.
- 2 - Select **General Settings** and press **➤** (right) to enter the menu.
- 3 - Select **USB Keyboard Settings**, and press **OK** to start the keyboard setup.

Special Keys

Keys for entering text

- Enter key = OK
- Backspace = delete character before cursor
- Arrow keys = navigate within a text field
- To switch between keyboard layouts, if a secondary layout is set, press the **Ctrl + Spacebar** keys simultaneously.

Keys for apps and Internet pages

- Tab and Shift + Tab = Next and Previous
- Home = scroll to the top of the page
- End = scroll to the bottom of the page
- Page Up = jump one page up
- Page Down = jump one page down
- + = zoom in one step
- - = zoom out one step
- * = fit the web page to the screen width

7.12

USB Flash Drive

You can view photos or play your music and videos from a connected USB flash drive.

Insert a USB flash drive in one of the **USB** connections on the TV while the TV is switched on.

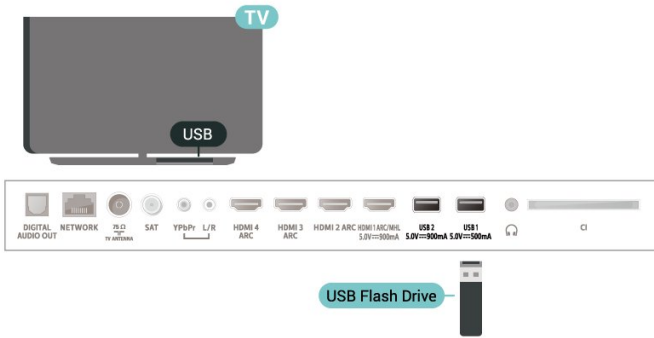

The TV detects the flash drive and opens a list showing its content. If the contents list does not appear automatically, press **SOURCES** and select **USB**.

To stop watching the USB flash drive content, press **TV EXIT** or select another activity. To disconnect the USB flash drive, you can pull out the flash drive anytime.

Ultra HD on USB

You can view photos in Ultra HD resolution from a connected USB device or flash drive. The TV will downscale the resolution to Ultra HD if the resolution of the photo is higher.

For more information on watching or playing content from a USB flash drive, in **Help**, press the colour key **Keywords** and look up **Photos, Videos and Music**.

7.13 Photo Camera

To view photos stored on your digital photo camera, you can connect the camera directly to the TV.

Use one of the **USB** connections on the TV to connect. Switch on the camera after you made the connection.

If the contents list does not appear automatically, press **SOURCES**, and select **USB**. Your camera might need to be set to transfer its content with PTP (Picture Transfer Protocol). Read the user manual of the digital photo camera.

Ultra HD on USB

You can view photos in Ultra HD resolution from a connected USB device or flash drive. The TV will downscale the resolution to Ultra HD if the resolution of the photo is higher. You cannot play a native Ultra HD video on any of the USB connections.

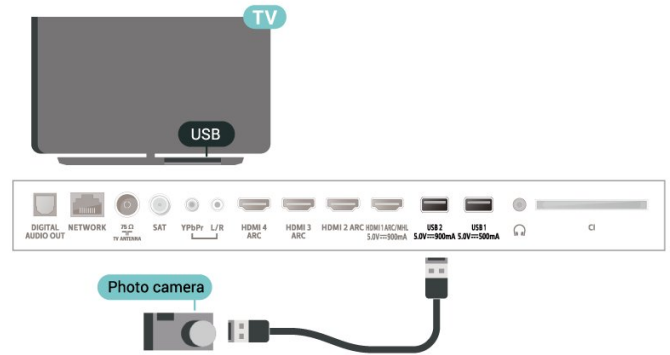

For more information on viewing photos, in **Help**, press the colour key **Keywords** and look up **Photos, Videos and Music**.

7.14 Camcorder

For best quality, use an HDMI cable to connect the camcorder to the TV.

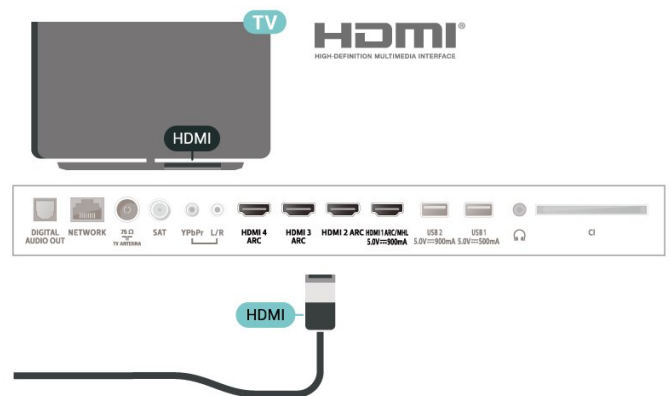

7.15 Computer

Connect

You can connect your computer to the TV and use the TV as a PC monitor.

With HDMI

Use an HDMI cable to connect the computer to the TV.

With DVI to HDMI

Alternatively, you can use a DVI to HDMI adapter (sold separately) to connect the PC to HDMI and an audio L/R cable (mini-jack 3.5mm) to AUDIO IN L/R on the back of the TV.

Connect your Android TV

Network and Internet

Home Network

To enjoy the full capabilities of your Philips Android TV, your TV must be connected to the Internet.

Connect the TV to a home network with a high-speed Internet connection. You can connect your TV wirelessly or wired to your network router.

Connect to Network

Wireless Connection



What You Need

To connect the TV to the Internet wirelessly, you need a Wi-Fi router with a connection to the Internet.

Use a high-speed (broadband) connection to the Internet.

Make the Connection

Make the Connection - Wireless



 (TV menu) >  Frequent Settings > Wireless and Networks > Wired or Wi-Fi > Connect to Network > Wireless.

1 - In the list of found networks, select on your wireless network. If your network is not in the list because the network name is hidden (you switched off the SSID broadcast of the router), select Add New Network to enter the network name yourself.

2 - Depending on the type of router, enter your encryption key - WEP, WPA or WPA2. If you entered the encryption key for this network before, you can select OK to make the connection immediately.

3 - A message will be shown when the connection is successful.

Make the Connection - WPS

 (TV menu) >  Frequent Settings > Wireless and Networks > Wired or Wi-Fi > Connect to Network > WPS.

If your router has WPS, you can directly connect to the router without scanning for networks. If you have



devices in your wireless network that use the WEP security encryption system, you cannot use WPS.

1 - Go to the router, press the WPS button and return to the TV within 2 minutes.

2 - Select Connect to make the connection.

3 - A message will be shown when the connection is successful.

Make the Connection - WPS with PIN Code

 (TV menu) >  Frequent Settings > Wireless and Networks > Wired or Wi-Fi > Connect to Network > WPS with PIN Code.

If your router has WPS with a PIN code, you can directly connect to the router without scanning for networks. If you have devices in your wireless network that use the WEP security encryption system, you cannot use WPS.

1 - Write down the 8-digit PIN code shown on screen and enter it in the router software on your PC. Consult the router manual on where to enter the PIN code in the router software.

2 - Select Connect to make the connection.

3 - A message will be shown when the connection is successful.

Problems

Wireless network not found or distorted

- Microwave ovens, DECT phones or other Wi-Fi 802.11b/g/n devices in your proximity might disturb the wireless network.
- Make sure that the firewalls in your network allow access to the TV's wireless connection.
- If the wireless network does not work properly in your home, try the wired network installation.

Internet does not work

- If the connection to the router is OK, check the router connection to the Internet.

The PC and Internet connection are slow

- Look in your wireless router's user manual for information on indoor range, transfer rate and other factors of signal quality.
- Use a high-speed (broadband) Internet connection for your router.

DHCP

- If the connection fails, you can check the DHCP (Dynamic Host Configuration Protocol) setting of the router. DHCP should be switched on.

In Help, press the colour key  **Keywords** and look up **Troubleshooting** for more information.

Wired Connection

What You Need

To connect the TV to the Internet, you need a network router with a connection to the Internet. Use a high-speed (broadband) connection to the Internet.

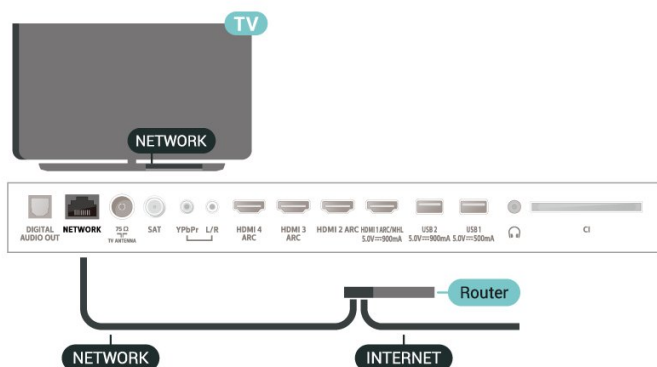

Make the Connection

(TV menu) > Frequent Settings > Wireless and Networks > Wired or Wi-Fi > Connect to Network > Wired.

- 1 - Connect the router to the TV with a network cable (Ethernet cable**).
- 2 - Make sure that the router is switched on.
- 3 - The TV constantly searches for the network connection.
- 4 - A message will be shown when the connection is successful.

If the connection fails, you can check the DHCP setting of the router. DHCP should be switched on.

**To fulfill EMC regulations, use a shielded FTP Cat. 5E Ethernet cable.

Network Settings

View Network Settings

(TV menu) > Frequent Settings > Wireless and Networks > Wired or Wi-Fi > View Network Settings.

You can view all current network settings here. The IP and MAC address, signal strength, speed, encryption method, etc.

Network Configuration - Static IP

(TV menu) > Frequent Settings > Wireless and Networks > Wired or Wi-Fi > Network

Configuration > Static IP.

If you are an advanced user and want to install your network with Static IP addressing, set the TV to Static IP.

Network Configuration - Static IP Configuration

(TV menu) > Frequent Settings > Wireless and Networks > Wired or Wi-Fi > Network Configuration > Static IP Configuration.

- 1 - Select Static IP Configuration and configure the connection.
- 2 - You can set the number for IP Address, Netmask, Gateway, DNS 1, or DNS 2.

Switch On with Wi-Fi (WoWLAN)

(TV menu) > Frequent Settings > Wireless and Networks > Wired or Wi-Fi > Switch On with Wi-Fi (WoWLAN).

You can switch this TV on from your smartphone or tablet if the TV is in Standby. The setting Switch On with Wi-Fi (WoWLAN) must be switched on.

Switch on with Chromecast

(TV menu) > Frequent Settings > Wireless and Networks > Wired or Wi-Fi > Switch on with Chromecast.

Set it **On** to allow this TV to be switched on from a Chromecast app on your mobile device. Power consumption of the TV in standby status will be higher when switched this on. The Wi-Fi (WoWLAN) setting should be turned on firstly before you can change the setting of Switch on with Chromecast.

Switch on Wi-Fi connection

(TV menu) > Frequent Settings > Wireless and Networks > Wired or Wi-Fi > Wi-Fi On/Off.

You can switch on or off Wi-Fi connection on your TV.

Digital Media Renderer - DMR

(TV menu) > Frequent Settings > Wireless and Networks > Wired or Wi-Fi > Digital Media Renderer - DMR.



If your media files do not play on your TV, make sure that the Digital Media Renderer is switched on. As a factory setting, DMR is switched on.

TV Network Name

 (TV menu) >  Frequent Settings > Wireless and Networks > Wired or Wi-Fi > TV Network Name.

If you have more than one TV in your home network, you can give the TV a unique name.

Clear Internet Memory

 (TV menu) >  Frequent Settings > Wireless and Networks > Wired or Wi-Fi > Clear Internet Memory.

With Clear Internet Memory you clear your Philips server registration and parental rating settings, your video store app logins, all Philips TV Collection favourites, Internet bookmarks and history. Interactive MHEG applications can also save so-called 'cookies', on your TV. These files will also be cleared.

8.2

Google Account

Sign In



To enjoy the full capabilities of your Philips Android TV, you can sign in to Google with your Google Account.

By signing in you'll be able to play your favourite games across phone, tablet and TV. You'll also get customised video and music recommendations on your TV home screen as well as access to YouTube, Google Play and other apps.

Sign In

Use your existing **Google Account** to sign in to Google on your TV. A Google Account consists of an email address and a password. If you don't have an Google Account yet, use your computer or tablet to create one (accounts.google.com). To play games with Google Play, you need a Google+ profile. If you did not sign in during the first TV installation, you can always sign in later.



To sign in after you did the TV installation...

- 1 - Press , select **All Settings** and press **OK**.
- 2 - Select **Android Settings** and press **OK**.
- 3 - Press  (down) and select **Personal** > **Add account** and press **OK**.
- 4 - Press **OK** on **SIGN IN**.
- 5 - With the on-screen keyboard, enter your email address and press **OK**.
- 6 - Enter your password and press the same small **OK** key to sign in.
- 7 - Press  (left) repeatedly if necessary, to close the menu.

Android Settings

You can set or view several Android specific settings or information. You can find the list of apps installed on your TV and the storage space they need. You can set the language you like to use with Voice Search. You can configure the onscreen keyboard or allow apps to use your location. Explore the different Android settings. You can go to www.support.google.com/androidtv for more information on these settings.

To open these settings...

- 1 - Press , select **All Settings** and press **OK**.
- 2 - Select **Android Settings**, and press **OK**.
- 3 - Explore the different Android settings.
- 4 - Press  **BACK** if necessary, to close the menu.

8.3

Home Screen

About the Home Screen

To enjoy the benefits of your Android TV, connect the TV to the Internet.

Like on your Android smartphone or tablet, the Home screen is the centre of your TV. From the Home screen you can decide what to watch by browsing entertainment options from app and live TV. Your Home has channels to let you discover great contents from your favourite apps. You can also add additional channels or find new apps to get more contents.

The Home screen is organised in channels...

Apps

Your favourite Apps are placed on the first row. In this row you will also find the Apps for TV, like **Philips TV Collection**, **Watch TV**, **TV Guide**, **Media** and others. You can find more apps in the Apps page which can be opened by clicking the **Apps** icon at the left end of the Favourite apps row. You can also add more apps as favourite from the Apps page.

The Apps page contains all installed Apps that come with the TV and the Apps you install from **Philips TV Collection** or **Google Play™ Store** yourself.

Play Next channel

You can always know what to watch next from **Play Next** channel on the Home screen. Start watching from where you left off and get notifications about new episodes in the **Play Next** channel. Press and hold **Select** on a movie or TV show to add it directly to the **Play Next** channel.

Google Play Movies & TV channel

Rent movies or TV shows on this channel from

Google Play Movies & TV.

Help channel

This channel contains "How to..." tutorial videos to let you know how to unbox, how to connect external devices, how to install channel, etc.

YouTube channel

This channel contains your Recommended, Subscriptions or Trending YouTube videos.



Customize channels

Click the **CUSTOMIZE CHANNELS** button to add and remove channels from your Home screen.

See also www.support.google.com/androidtv

Open the Home Screen

To open the Home screen and open an item...

- 1 - Press  HOME.
- 2 - Select an item and press **OK** to open or start it.
- 3 - Press  BACK continuously or press  HOME can go back to Home screen.

When opening the Home screen, the background application/content playback will stop. You have to select the application or content from the Home screen to resume.

8.4

Philips TV Collection App

Featured Apps page

All your premium apps are available within the Philips TV Collection app, under Featured apps section. Launch it using the banner on the Favourite apps channel.

Philips TV Collection apps are made specially for TV. Downloading and installing Philips TV Collection apps are free of charge. The Philips TV Collection of apps can differ per country or region. The Philips TV Collection will also contain recommendations for new Apps and more.

Some Philips TV Collection apps are pre-installed on your TV. To install other apps from Philips TV Collection, you will be asked to agree to the Terms of Use. You can set the Privacy Settings according to your preference.

To install an app from the Philips TV Collection...

- 1 - Press  HOME.
- 2 - Select  Philips TV Collection and press **OK**. It will open the Featured apps section.
- 3 - Select the "All" tab and press **OK**. It will display all

the apps that are available to the user, including the installed ones.

4 - Browse through the apps and select the app icon that you want to install, and press **OK**. It will open the App info page.



5 - Select the **Add** button and press **OK** to install the app.

The installed app found in the Apps page, which can be opened from the Android Home screen by pressing the Apps icon at the left end of the Favourite Apps row.

Terms of Use

To install and use the Philips TV Collection apps, you must agree to the Terms of Use. If you did not agree to these terms during the first TV installation, you can always agree to them later. The moment you agree to the Terms of Use, some apps will be available immediately and you can browse the Philips TV Collection to install other apps.

To agree on the Terms of Use after you did the TV installation...



- 1 - Press  HOME, select  Philips TV Collection and press **OK**. Press the **Options** key to open the Options menu.
- 2 - You can select **Terms of Use**, then press **OK** to read.
- 3 - Select **Accept** and press **OK**. You cannot undo this approval.
- 4 - Press  BACK to close the menu.

Privacy Settings

You can set some privacy settings for the Philips TV Collection apps.

- You can allow technical statistics to be send to Philips.
- You can allow personal recommendations.
- You can allow cookies.
- You can switch on the Child Lock for 18+ rated apps.

To set the Philips TV Collection privacy settings...

- 1 - Press  HOME, select  Philips TV Collection and press **OK**. Press the **Options** key to open the Options menu.
- 2 - You can select **Privacy Policy**, then press **OK**.
- 3 - Select each setting and press **OK** to allow or disallow. You can read about each setting in detail.
- 4 - Press  BACK to close the menu.

Apps

About Apps

You can find your favourite Apps on Apps row in the Home menu.

Like apps on your smartphone or tablet, the apps on your TV offer specific functions for an enriched TV experience. Apps like YouTube, games, video stores or weather forecasts (a.o.). You can use the Internet Browser app to surf the Internet.

Apps can come from the **Philips TV Collection** or the **Google Play™ Store**. To get you started, some practical apps are pre-installed on your TV.

To install apps from the **Philips TV Collection** or the **Google Play™ Store**, the TV must be connected to the Internet. You must agree to the Terms of Use to use apps from the **Philips TV Collection**. You must sign in with a Google Account to use the Google Play apps and Google Play™ Store.

Google Play

Movies and TV

With **Google Play Movies & TV**, you can rent or buy movies and TV shows to watch on TV.







What You Need

- your TV must be connected with the Internet
- you must sign in with your Google Account on TV
- add a credit card to your Google Account to purchase movies and TV shows

To rent or buy a movie or TV show...

- 1 - Press  HOME.
- 2 - Select **Google Play Movies & TV**.
- 3 - Select a movie or TV show and press **OK**.
- 4 - Select the purchase you want and press **OK**. You will be taken through the purchase procedure.

To watch a rented or bought movie or TV show...

- 1 - Press  HOME.
- 2 - Select **Google Play Movies & TV**.
- 3 - Select the movie or TV show from your library in the app, select the title and press **OK**.
- 4 - You can use the  (stop),  (pause),  (rewind) or  (fast forward) keys on the remote control.
- 5 - To stop the Movies & TV app, press  **BACK** repeatedly or press  **EXIT**.

If the App is not on your Home screen, you can add

via the Apps page or by the **Add app to favourites** item on the **Favourite apps** row. Some Google Play products and features aren't available in all countries.

Find more information on support.google.com/androidtv

Music



With Google Play Music, you can play your favourite music on TV.

With Google Play Music you can buy new music on your computer or mobile device. Or, on your TV, you can sign up for All Access, the Google Play Music subscription. Alternatively, you can play the music you already own, stored on your computer.

What You Need

- your TV must be connected with the Internet
- you must sign in with your Google Account on TV
- add a credit card to your Google Account to take a music subscription

To start Google Play Music...

- 1 - Press  HOME.
- 2 - Select **Google Play Music**.
- 3 - Select the music you want and press **OK**.
- 4 - To stop the Music app, press  **BACK** repeatedly or press  **EXIT**.

If the App is not on your Home screen, you can add via the Apps page or by the **Add app to favourites** item on the **Favourite apps** row. Some Google Play products and features aren't available in all countries.

Find more information on support.google.com/androidtv

Games

With Google Play Games, you can play games on TV. Online or offline.

You can see what your friends are playing currently or you can join the game and compete. You can track your achievements or start wherever you left off.

What You Need

- your TV must be connected with the Internet
- you must sign in with your Google Account on TV
- add a credit card to your Google Account to purchase new games

Start the Google Play Games app to select and install new game apps on your TV. Some games are free of charge. A message appears if a particular game needs a gamepad to play the game.

To start or stop a Google Play Game...

- 1 - Press  HOME.

- 2 - Select **Google Play Games**.
- 3 - Select a game to play or select a new game to install and press **OK**.
- 4 - When done, press **← BACK** repeatedly or press **TV EXIT** or stop the app with its dedicated exit/stop button.

If the App is not on your Home screen, you can add via the Apps page or by the **Add app to favourites** item on the **Favourite apps** row. Some Google Play products and features aren't available in all countries.

Find more information on support.google.com/androidtv

Google Play Store

From the Google Play Store you can download and install new apps. Some apps are free of charge.

What You Need

- your TV must be connected with the Internet
- you must sign in with your Google Account on TV
- add a credit card to your Google Account to purchase apps

To install a new app...

- 1 - Press **HOME**.
- 2 - Select **Google Play Store** and press **OK**.
- 3 - Select the app you want to install and press **OK**.
- 4 - To close the **Google Play Store**, press **← BACK** repeatedly or press **TV EXIT**.

Parental controls

In the Google Play Store, you can hide apps according to users/buyers maturity. You need to enter a PIN code to select or change the level of maturity.

To set the parental control...

- 1 - Press **HOME**.
- 2 - Select **Google Play Store** and press **OK**.
- 3 - Select **Settings > Parental controls**.
- 4 - Select the level of maturity you want.
- 5 - On request, enter the PIN code.
- 6 - To close the **Google Play Store**, press **← BACK** repeatedly or press **TV EXIT**.

If the App is not on your Home screen, you can add via the Apps page or by the **Add app to favourites** item on the **Favourite apps** row. Some Google Play products and features aren't available in all countries.

Find more information on support.google.com/androidtv

Payments

To make a payment on Google Play on TV, you must add a form of payment - a credit card (outside the United States) - to your Google Account. When you purchase a movie or TV show, you will be charged on this credit card.

To add a credit card ...

- 1 - On your computer, go to accounts.google.com and sign in with the Google Account you will use with Google Play on TV.
- 2 - Go to wallet.google.com to add a card to your Google Account.
- 3 - Enter your credit card data and accept the terms and conditions.

9.3

Start or Stop an App

You can start an app from the Home screen.

To start an app...

- 1 - Press **HOME**.
- 2 - Move to **Favourite apps** row, select the app you want and press **OK**.
- 3 - To stop an app, press **← BACK** or press **TV EXIT** or stop the app with its dedicated exit/stop button.

When opening the Home screen, the background application/content playback will stop. You have to select the application or content from the Home screen to resume.

9.4

Lock Apps

About App Locks

You can lock apps unsuited for children. You can lock 18+ rated apps or set up a restricted profile in the Home menu.

18+

The 18+ app lock will ask for a PIN code when you try to start an 18+ rated app. This lock is only valid for 18+ rated apps from the Philips apps.

Restricted profile

You can set up a restricted profile for the Home menu where only the apps you allow are available. You need to enter a PIN code to set up and switch on the restricted profile.

Google Play Store - Maturity

In the Google Play Store, you can hide apps

according to users/buyers maturity. You need to enter a PIN code to select or change the level of maturity. The level of maturity will determine which apps are available for installation.

Lock 18+ rated apps

You can lock 18+ rated apps from the Philips apps. This setting controls the 18+ setting in the Philips apps Privacy Settings.

To lock 18+ rated apps...

- 1 - Press , select **All Settings** and press **OK**.
- 2 - Select **Child Lock**, select **App Lock** and press **OK**.
- 3 - Select **On** and press **OK**.
- 4 - Press **←** (left) repeatedly if necessary, to close the menu.

For more information, in **Help**, press the colour key  **Keywords** and look up **Child Lock**, **App Lock** for more information.

Restricted Profile

About Restricted Profile

You can restrict the use of certain apps by switching the TV to a restricted profile. The Home menu will only show the apps you allowed. You need a PIN code to switch out of the restricted profile.

With the TV switched to a restricted profile you cannot...

- Find or open apps which are marked as Not allowed
- Access the Google Play Store
- Purchase through Google Play Movies & TV, nor Google Play Games
- Use third-party apps that don't use the Google sign-in

With the TV switched to a restricted profile you can...

- Watch content already rented or purchased from Google Play Movies & TV
- Play games already purchased and installed from Google Play Games
- Access the following settings: Wi-Fi network, Speech and Accessibility
- Add Bluetooth accessories

The Google Account on TV will stay logged in. Using a restricted profile doesn't change the Google Account.

Set Up

To set up the restricted profile...

- 1 - Press , select **All Settings** and press **OK**.
- 2 - Select **Android Settings** and press **OK**.

3 - Press **▼** (down) and select **Personal > Security & restrictions** and press **OK**.

4 - Select **Restricted Profile** and press **OK**.

5 - Select **Settings** and press **OK**.

6 - Enter a PIN code with the remote control.

7 - Select **Allowed apps** and press **OK**.

8 - In the list of available apps, select an app and press **OK** to allow or not allow this app.

9 - Press **← BACK** to go back one step or press  **EXIT** to close the menu.

Now you can enter the restricted profile.

With the PIN code, you can always change the PIN code or edit the list of allowed or not allowed apps.

Enter

To enter (switch to) the restricted profile...

1 - Press , select **All Settings** and press **OK**.

2 - Select **Android Settings** and press **OK**.

3 - Press **▼** (down) and select **Personal > Security & restrictions** and press **OK**.

4 - Select **Enter restricted profile** and press **OK**.

5 - Enter a PIN code with the remote control.

6 - Press **← BACK** to go back one step or press  **EXIT** to close the menu.

You can see when a restricted profile is entered if an icon appears in the Home screen. Scroll down to  **Settings** and scroll to the far right.

Delete

To delete the restricted profile...

1 - Press , select **All Settings** and press **OK**.

2 - Select **Android Settings** and press **OK**.

3 - Press **▼** (down) and select **Personal > Security & restrictions** and press **OK**.

4 - Select **Delete restricted profile** and press **OK**.

5 - Enter the PIN code. The TV will delete the restricted profile.

9.5

Manage Apps

If you stop an app and return to the Home menu, the app is not really stopped. The app is still running in the background to be readily available when you start it again. To run fluently, most apps need to save some data in the cache memory of the TV. It might be good to stop an app completely or clear the cache data of a particular app to optimise the overall performance of apps and to keep memory usage low on your Android TV. Also, it is best to uninstall apps that you



are not using anymore.

9.6

Storage

You can see how much storage space - the internal TV memory - you are using for your apps, videos, music, etc. You can see how much free space you still have available for installing new apps. Check your storage if apps start to run slow or in case of app trouble.

To see how much storage you are using...

- 1 - Press , select **All Settings** and press **OK**.
- 2 - Select **Android Settings** and press **OK**.
- 3 - Select **Device > Storage & reset** and press **OK**.
- 4 - View the storage usage of the TV memory.
- 5 - Press  **BACK** to go back one step or press  **EXIT** to close the menu.

USB Hard Drive

If you connect a USB Hard Drive, you can use the drive to extent the TV memory to store more apps. Allow the USB Hard Drive to be used as an additional TV memory during the formatting process. The TV will try to store new apps on the USB Hard Drive first. Some apps do not allow to be stored on a USB Hard Drive.

To migrate your existing data, go to **All Settings > Android Settings > Device > Storage & reset** and select the **USB Hard Drive**.





Internet

Start Internet

You can browse the Internet on your TV. You can view any Internet website but most of them are not prepared for a TV screen.

- Some plug-ins (e.g. to view pages or videos) are not available on your TV.
- You cannot send or download files.
- Internet pages are shown one page at a time and full screen.

To start the Internet browser...

- 1 - Press  HOME.
- 2 - Select **Apps > Internet Browser** and press **OK**.
- 3 - Enter an Internet address and select , press **OK**.
- 4 - To close Internet, press  HOME or  EXIT.

* Note: If **Internet Browser** is not on your **Favourite apps row**, you can press + icon on the end of channel to add the app.

Options on Internet

Some extras are available for the Internet.

To open the extras...

- 1 - With the website open, press **+ OPTIONS**.
 - 2 - Select one of the items and press **OK**.
- Add to speed dial: To enter a new Internet address.
 - Add to bookmarks: Add the page as bookmark
 - Page security: To view the security level of the current page.
 - New private tab: Open new private tab, and have private browsing
 - Settings: Settings for Zoom, Text size, Accessibility mode, Always show menu bar, and clear (browsing) history
 - Help: Internet browser information
 - Exit Internet browser: Close Internet browser

TV Menu

About TV Menu

If the TV cannot be connected with the Internet, you can use the **TV Menu** as your Home menu.

In the TV Menu, you will find every TV function.

Open TV Menu

To open TV Menu and open an item...

- 1 - Press  to open TV Menu.
- 2 - Select an item and press **OK** to open or start it.
- 3 - Press **← BACK** to close TV Menu without starting anything.



Sources

12.1

Switch to a device

From the list of Sources, you can switch to any of the connected devices. You can switch to a tuner to watch TV, open the content of a connected USB Flash Drive or see the recordings you made on a connected USB Hard Drive. You can switch to your connected devices to watch their programme, a digital receiver or a Blu-ray Disc player.

To switch to a connected device...

- 1 - Press  **SOURCES** to open the Sources menu.
- 2 - Select one of the item in the source list and press **OK**. The TV will show the programme or content of the device.
- 3 - Press  **SOURCES** again to close the menu.

One Touch Play

With the TV in standby, you can switch on a disc player with your TV remote control.

To switch on both disc player and TV from standby and start playing the disc immediately, press  (play) on the TV remote control. The device must be connected with an HDMI cable and both TV and device must have HDMI CEC switched on.

12.2

Options for a TV Input

Some TV input devices offer specific settings.

To set the options for a specific TV input...

- 1 - Press  **SOURCES**.
- 2 - Select the TV input in the list and press **OK**.
- 3 - Press **+** **OPTIONS**. You can set the options for the selected TV input here.
- 4 - Press **+** **OPTIONS** again to close the Options menu.

Possible options...

Controls

With this option you can operate the connected device with the TV remote control. The device must be connected with an HDMI cable and both TV and device must have HDMI CEC switched on.

Device Info

Open this option to view information on the connected device.

Device Name and Type





When you connect a new device to the TV and the TV detects the device, you can assign an icon that fits the device type. If you connect a device with an HDMI cable and HDMI CEC, the TV detects the device type automatically and the device gets an appropriate icon.

The device type determines picture and sound styles, resolution values, specific settings or the position within the Sources menu. You don't have to worry about the ideal settings.

Rename or Change Type





You can always change the name or change the type of a connected device. Look for the  icon at the right of the device name in the Sources menu. Some TV input sources do not allow a name change.

To change the device type...

- 1 - Select the device in the Sources menu.
- 2 - Press  (right) to select the  icon and press **OK**.
- 3 - Press  **BACK** to hide the on-screen keyboard.
- 4 - Press  (down) to find all available device types. Select the type you want and press **OK**.

- 5 - If you want to reset the type of the device to the original connector type, select **Reset** and press **OK**.
- 6 - Select **Close** and press **OK** to close this menu.

To change the device name...



- 1 - Select the device in the Sources menu.
- 2 - Press  (right) to select the  icon and press **OK**.
- 3 - Use the on-screen Keyboard to delete the current name and enter a new one. Press  to confirm.
- 4 - Press  **BACK** to hide the on-screen keyboard.
- 5 - If you want to reset the name of the device to the original connector name, select **Reset** and press **OK**.
- 6 - Select **Close** and press **OK** to close this menu.

12.4

Rescan Connections

You can rescan all TV connections to update the Sources menu with recently connected devices.

To rescan the connections...

- 1 - Press  **SOURCES** to open the Sources menu.
- 2 - Press  (up) to select the  icon at the top right of the Sources menu.
- 3 - Press **OK** to start scanning the connections. Newly connected devices will be added to the

Sources menu.

Networks

13.1

Network

For more information, in **Help**, press the colour key **— Keywords** and look up **Network**, for more information on connecting the TV to a network.

13.2

Bluetooth

Pairing a Device

For more information, in **Help**, press the colour key **— Keywords** and look up **Bluetooth, Pairing** for more information on pairing wireless devices.

Select a Device

For more information, in **Help**, press the colour key **— Keywords** and look up **Bluetooth, Select device** for more information on how to select a wireless device.

Remove a Device

For more information, in **Help**, press the colour key **— Keywords** and look up **Bluetooth, Remove device** for more information on how to unpair (remove) a wireless Bluetooth device.

Settings

14.1

Picture



Picture Settings

Picture Style



Select a style

⚙ Settings > All settings > Picture > Picture style.

For easy picture adjustment, you can select a preset picture style.

- Personal - The picture preferences you set during the first start up.
- Vivid - Ideal for daylight viewing
- Natural - Natural picture settings
-  Standard - Most energy conscious setting - Factory setting
- Movie - Ideal for watching movies
- Game - Ideal for playing games
- Monitor - Ideal for PC display
-  Day - For ISF Calibration
-  Night - For ISF Calibration

When TV receives HDR signal, select a picture style below:

- HDR Personal
- HDR Vivid
- HDR Natural
- HDR Movie
- HDR Game
-  Day - For ISF Calibration
-  Night - For ISF Calibration

Restore a Style

- 1 - Select the picture style you want to restore.
- 2 - Press the colour key  Restore style, and press OK. The style is restored.

Customise a Style



Any picture setting you adjust, like Colour or Contrast, is stored in the currently selected **Picture Style**. It allows you to customise each style.

Only the style **Personal** can save its settings for each source in the Sources menu.

Colour, Contrast, Sharpness, Brightness

Adjust the picture colour



⚙ Settings > All settings > Picture > Colour.

Press the arrows  (up) or  (down) to adjust the

colour saturation value of the picture.

Adjust the picture contrast



⚙ Settings > All settings > Picture > Contrast.

Press the arrows  (up) or  (down) to adjust the contrast value of the picture.

You can decrease contrast value to reduce power consumption.



Adjust the picture sharpness

⚙ Settings > All settings > Picture > Sharpness.

Press the arrows  (up) or  (down) to adjust the sharpness value of the picture.

Adjust brightness

⚙ Settings > All settings > Picture > Brightness.

Press the arrows  (up) or  (down) to set the level of brightness of the picture signal.

Note: Setting of brightness much away from reference value (50) may result lower contrast.

Advanced Picture Settings

Colour Settings

Advanced Colour Settings

⚙ Settings > All settings
> Picture > Advanced > Colour.

Adjust the colour enhancement

⚙ Settings > All settings
> Picture > Advanced > Colour > Colour enhancement.

Select **Maximum**, **Medium**, or **Minimum** to set the level of the colour intensity and the details in bright colours.

Adjust the colour gamut

⚙ Settings > All settings
> Picture > Advanced > Colour > Colour gamut.

Select **Normal** or **Wide** to set the type of colour gamut.

Select the preset colour temperature

⚙ Settings > All settings > Picture > Advanced >

Colour > Colour temperature.

Select **Normal**, **Warm**, or **Cool** to set the colour temperature for your preference.

Customise colour temperature

⚙️ **Settings > All settings > Picture > Advanced > Colour > Custom Colour temperature.**

Select Custom in Colour temperature menu to customise a colour temperature yourself. Press the arrows **▲** (up) or **▼** (down) to adjust the value. WP is white point and BL is black level. You can also select one of the presets in this menu.

ISF Colour Settings

About ISF

Get the most out of your TV display with **ISF® Calibration**. Ask a ISF calibration expert to come to your home and set the TV to the most optimal picture setting.

Ask your dealer for an ISF Calibration.

Calibration benefits are...

- better picture clarity and sharpness
- better detail in bright and dark parts
- deeper and darker blacks
- better colour purity and quality
- optimise the picture viewing effect in your home for both daylight and night conditions

The ISF Calibration expert stores and locks the ISF settings as two picture styles.

When the ISF Calibration is done, press ⚙️ **Settings > All settings > Picture > Picture**

Style > ISF Day or **ISF Night**. Select **ISF Day** to watch TV during bright light conditions or select **ISF Night** when it's dark.

Colour control (Hue, Saturation and Intensity)

⚙️ **Settings > All settings > Picture > Advanced > Colour > Colour control.**

Press the arrows **▲** (up) or **▼** (down) to adjust the value of Hue, Saturation and Intensity, or select **Reset all** to reset all value to default.

RGB only mode

⚙️ **Settings > All settings > Picture > Advanced > Colour > RGB only mode.**

Select Red, Green, or Blue to switch picture as selected colour only, or select **Off** to turn off RGB mode.

Advanced Contrast Settings

Contrast Modes

⚙️ **Settings > All settings > Picture > Advanced > Contrast > Contrast mode.**

Select **Normal**, **Optimized for picture**, or **Optimized for energy savings** to set the TV automatically reduces the contrast, for best power consumption or for best picture experience.

HDR Settings

If you are watching HDR programmes - programmes recorded in HDR - there is no need to upscale to HDR and the HDR setting is unavailable. The TV can play HDR programmes from a HDMI connection, from an Internet source or from a connected USB memory device.

If you are watching HDR (High-Dynamic Range) programmes - programmes recorded in HDR - The TV will automatically switched to HDR mode with indication.

HDR Upscaling control is unavailable. The TV can play HDR programmes* from **HDMI 1** or **HDMI 2** connection, broadcasting, from an Internet source or from a connected USB memory device.

* Only HDR10 and Hybrid Log Gamma HDR are supported

HDR Upscaling, High Brightness and HDR Conversion

⚙️ **Settings > All settings > Picture > Advanced > Contrast > HDR upscaling / High Brightness / HDR Conversion.**

Select **On** to boost the brightness and contrast of the picture. The picture is much brighter and has a higher level of contrast between lighter and darker parts. HDR upscaling keeps colours rich and saturated. Set the level of HDR Conversion or see the demo on live video.

Note:

- Available when SDR (Standard Dynamic Range) signal is detected.
- Not available when video content is supported HDR.

HDR Perfect

⚙️ **Settings > All settings**

> Picture > Advanced > Contrast > HDR Perfect.

Select HDR Perfect for superior contrast and brightness effect.

Note: Available when HDR (High-Dynamic Range) signal is detected.

Dynamic Contrast

⚙ Settings > All settings
> Picture > Advanced > Contrast > Dynamic contrast.

Select Maximum, Medium, or Minimum to set the level at which the TV automatically enhances the details in the dark, middle and light areas of the picture.

Video Contrast, Gamma

Video contrast

⚙ Settings > All settings
> Picture > Advanced > Contrast > Video contrast.

Press the arrows **▲** (up) or **▼** (down) to adjust the video contrast level.

Gamma

⚙ Settings > All settings
> Picture > Advanced > Contrast > Gamma.

Press the arrows **▲** (up) or **▼** (down) to set a non-linear setting for picture luminance and contrast.

Light Sensor

⚙ Settings > All settings
> Picture > Advanced > Contrast > Light sensor.

Select On to adjust the picture settings automatically to the lighting conditions of the room.

Advanced Sharpness Settings

Ultra Resolution

⚙ Settings > All settings
> Picture > Advanced > Sharpness > Ultra Resolution.

Select On to have a superior sharpness in line edges and details.

Picture Clean

Noise reduction

⚙ Settings > All settings
> Picture > Advanced > Picture clean > Noise reduction.

Select Maximum, Medium, or Minimum to set the level for removing the noise in video content. Noise is mostly visible as small moving dots in on-screen picture.

MPEG Artefact Reduction

⚙ Settings > All settings
> Picture > Advanced > Picture clean > MPEG Artefact Reduction.

Select Maximum, Medium, or Minimum to have different degrees of smoothing the artefacts in digital video content.

MPEG artefacts are mostly visible as small blocks or jagged edges in on-screen images.

Motion Settings

Perfect Natural Motion

Motion Styles

⚙ Settings > All settings
> Picture > Advanced > Motion > Motion styles.

Motion styles provides optimised motion setting modes for different video content.

Select one of the motion styles to have better viewing experience.
(Movie, Sports, Standard, Smooth, Personal)

Not available for below cases:

- ⚙ Settings > All settings > Picture > Picture style > Monitor.
- ⚙ Settings > All settings > Picture > Picture style > Game.

Perfect Natural Motion

⚙ Settings > All settings
> Picture > Advanced > Motion > Perfect Natural Motion.

Perfect Natural Motion makes any movement smooth and fluent.

Select Maximum, Medium, or Minimum to have different degrees for reducing the motion judder, visible in movies on TV.

Select Minimum or Off when noise appears in playing moving picture on-screen.

Note: Only available when Motion styles set to Personal.

Perfect Clear Motion

⚙ Settings > All settings
> Picture > Advanced > Motion > Perfect Clear Motion.

Perfect Clear Motion makes any movement smooth and fluent.

Select Maximum, Medium, or Minimum to have different degrees for reducing the motion judder, visible in movies on TV.

Select Minimum or Off when noise appears in playing moving picture on-screen.

Note: Only available when Motion styles set to Personal.

Clear Residual Image

Displaying a still image for a prolonged period of time may cause an image sticking. This phenomenon is normal character for OLED panel. Avoid displaying a fixed image on the TV screen for an extended length of time.

Screen saver

To reduce the chances of residual images on the TV screen, the screen saver (moving PHILIPS logo) will be triggered in such circumstances.

- when static setting menu elements are shown on screen for more than 2 minutes.
- when static setting menu elements of Apps are shown on screen for more than 2 minutes.
- when Teletext is being displayed for more than 2 minutes.

The screen saver will not be triggered in such circumstances.

- pausing playback on an external source (e.g. HDMI), as the TV is not displaying static setting menu elements.

Once the screen saver is active, it can be closed by pressing any remote control button. Other actions like inserting a USB stick or casting content will execute in the background, but these activities will not interrupt the screen saver.

Clear residual image

When you encounter image residual on the TV, you can clear such image retention on-screen by activating this function.

- 1 - Press ⚙, select **All Settings** and press **OK**.
- 2 - Select **Picture** and press **➤ (right)** to enter the menu.

- 3 - Select **Advanced > Clear residual image**.
- 4 - Select **Confirm**.

The TV will be switched off until the process is completed.

If you are recording something, the process will be paused, and restart until the recording is completed. It might take more than 1 hour.

If you turn the TV on during the process, it will be stopped and will be restarted automatically when the TV switches to standby at a later time.

While processing, a white line may appear on the screen. This is normal when clearing on-screen image retention.

Picture Format

If the picture is not filling the whole screen, if black bars are showing on the top or bottom or at both sides, you can adjust the picture to fill the screen completely.

To select one of the basic settings to fill the screen...

- 1 - While watching a TV channel, press ⚙.
- 2 - Select **Picture Format > Fill Screen, Fit to Screen, Wide Screen and Original**, and press **OK**.
- 3 - Press **◀ (left)** repeatedly if necessary, to close the menu.
 - **Fill Screen** – automatically enlarges the picture to fill the screen. Picture distortion is minimal, subtitles remain visible. Not suitable for PC input. Some extreme picture formats can still show black bars.
 - **Fit to Screen** – automatically zooms in the picture to fill the screen without distortion. Black bars may be visible. Not suitable for PC input.
 - **Wide Screen** – automatically zooms in the picture to wide screen.
 - **Original** – automatically zooms in the picture to wide screen.

To format the picture manually...

- 1 - While watching a TV channel, press ⚙.
- 2 - Select **Advanced** and press **OK**.
- 3 - Use **Shift, Zoom, and Stretch** to adjust the picture.
- 4 - Or select **Undo** to return to the setting the picture had when you opened **Picture Format**.
 - **Shift** – Select on the arrows to shift the picture. You can only shift the picture when it is zoomed in.
 - **Zoom** – Select on the arrows to zoom in.
 - **Stretch** – Select on the arrows to stretch the picture vertically or horizontally.
 - **Undo** – Select to return to the picture format you started with.

Quick Picture Setting

During the first installation, you did some picture settings in a few easy steps. You can redo these steps with **Quick Picture Setting**. To do these steps, make sure the TV can tune to a TV channel or can show a programme from a connected device.

To set the picture in a few easy steps...

- 1 - Press , select **All Settings** and press **OK**.
- 2 - Select **Picture** and press **➤** (right) to enter the menu.
- 3 - Select **Quick Picture Setting**, and press **OK**.
- 4 - Use the navigation keys to select your choice.
- 5 - Press **◀** (left) repeatedly if necessary, to close the menu.

14.2

Sound

Sound Style

Select a style

-  Settings > All settings > Sound > Sound style.

For easy sound adjustment, you can select a preset setting with sound style.

- Original - Most neutral sound setting
- Movie - Ideal for watching movies
- Music - Ideal for listening to music
- Game - Ideal for gaming
- News - Ideal for speech
- Expert mode - Access to a more in depth sound settings.

Restore a Style

- 1 - Select the sound style you want to restore.
- 2 - Press the colour key  Restore Style, and press OK. The style is restored.

Expert mode settings

DTS TruSurround

-  Settings > All settings > Sound > Expert mode settings > DTS TruSurround.

Press the arrows **▲** (up) or **▼** (down) to adjust the level of DTS TruSurround.

Clear dialogue

-  Settings > All settings > Sound > Expert mode settings > Clear dialogue > On.

Select On to get an improved sound quality for speech programme.

Equalizer

-  Settings > All settings > Sound > Expert mode settings > Equalizer.

Press the arrows **▲** (up) or **▼** (down) to adjust the level of Equalizer.

Headphone Volume

Headphone volume

-  Settings > All settings > Sound > Headphone volume.

Press the arrows **▲** (up) or **▼** (down) to adjust the volume of a connected headphone separately.

TV placement

-  Settings > All settings > Sound > TV placement.

Select On a TV stand or On the wall to have best sound reproduction according to the setting.

Advanced Sound Settings

Volume Control

Auto volume

-  Settings > All settings > Sound > Advanced > Auto volume.

Select **DTS TruVolume** to deliver a robust consistent output.

Select **Night Mode** for a more comfortable quiet listening experience.

Delta volume

-  Settings > All settings > Sound > Advanced > Delta volume.

Press the arrows **▲** (up) or **▼** (down) to adjust the delta value for TV speaker volume.

Audio Out Settings

-  Settings > All settings > Sound > Advanced > Audio out.

Set the TV to play the sound on TV or on the connected audio system.

You can select where you want to hear the TV sound and how you want to control it.

- If you select **TV speakers off**, you permanently switch off the TV speakers.
- If you select **TV speakers**, the TV speakers are always on. All the sound related settings (Bass, Treble, Surround mode etc) are applicable to this mode.
- If you select **Headphones**, the sound will be played through headphones.

With an audio device connected with HDMI CEC, select **HDMI sound system**. The TV will switch off the TV speakers when the device is playing the sound.

Digital Output Settings

Digital output settings are available for optical and HDMI ARC sound signals.

Digital out format

⚙ Settings > All settings
> Sound > Advanced > Digital out format.

Set the audio out signal of the TV to fit the sound capabilities of the connected Home Theatre System.

- **Stereo (uncompressed)**: If your audio playback devices have no multichannel sound processing, select to only output stereo content to your audio playback devices.
- **Multichannel**: Select to only output 5.1 audio content (compressed multichannel sound signal) to your audio playback devices.
- **Multichannel (bypass)**: Select to send original bitstream from HDMI ARC to the connected HDMI Sound System.
- **Dolby Digital Plus**: Select to output Dolby Digital Plus or DTS content to your audio playback devices or Home theatre system.

- Make sure your audio playback devices support Dolby Atmos feature.

- SPDIF output (DIGITAL AUDIO OUT) will be disabled when streaming Dolby Digital Plus content.

Digital out levelling

⚙ Settings > All settings
> Sound > Advanced > Digital out levelling.

Adjust the loudness level from device which is connected to digital audio output (SPDIF) or HDMI.

- Select **More** to have louder volume.
- Select **Less** to have softer volume.

Digital out delay

⚙ Settings > All settings
> Sound > Advanced > Digital out delay.

For some Home Theatre Systems you might need to adjust the audio sync delay to synchronise the audio to the video. Select **Off** if a sound delay is set on your Home Theatre System.

Digital out offset (Only available when Digital out delay set to On)

⚙ Settings > All settings
> Sound > Advanced > Digital out offset.

If you cannot set a delay on the Home Theatre System, you can set the TV to sync the sound. You can set an offset that compensates for the time necessary for the Home Theatre System to process the sound of the TV picture. You can set the value in steps of 5ms. Maximum setting is 60ms.

14.3

Ambilight Settings

Turn Ambilight On or Off

Turn off Ambilight

Press  **AMBILIGHT** and select **Off**, or you can turn **Off** by pressing ⚙ Settings > All settings > Ambilight > Ambilight style > **Off**.

Ambilight Style

You can select the way Ambilight follows.

⚙ Settings > All settings > Ambilight > Ambilight style.

Follow video

⚙ Settings > All settings > Ambilight > Ambilight style > **Follow video**.

Select one of the styles that follow the dynamics of the picture on your TV screen.

- **Standard** - Ideal for day to day TV watching
- **Natural** - Follows the picture or sound as truthful as possible
- **Football** - Ideal for football games
- **Vivid** - Ideal for daylight conditions
- **Game** - Ideal for gaming
- **Comfort** - Ideal for a quiet evening
- **Relax** - Ideal for a lounge feeling

Follow audio

⚙ Settings > All settings > Ambilight > Ambilight style > Follow audio.

Select one of the styles that follow the dynamics of the sound.

- Lumina - Mixes audio dynamics with video colours
- Colora - Based on audio dynamics
- Retro - Based on audio dynamics
- Spectrum - Based on audio dynamics
- Scanner - Based on audio dynamics
- Rhythm - Based on audio dynamics
- Party - A mix of all Follow Audio styles, one after the other

Follow colour

⚙ Settings > All settings > Ambilight > Ambilight style > Follow colour.

Select one of the preset colour styles.

- Hot lava - Red colour variations
- Deep water - Blue colour variations
- Fresh nature - Green colour variations
-  Warm white - Static colour
- Cool white - Static colour

Follow flag

⚙ Settings > All settings > Ambilight > Ambilight style > Follow flag.

Let Ambilight follow the country flag you select.

Follow app



⚙ Settings > All settings > Ambilight > Ambilight style > Follow app.

This function is available when you control Ambilight with an app.

Ambilight Brightness, Saturation



Brightness

⚙ Settings > All settings > Ambilight > Brightness.

Press the arrows  (up) or  (down) to set the level of Ambilight brightness.

Saturation

⚙ Settings > All settings > Ambilight > Saturation.

Press the arrows  (up) or  (down) to set the level of Ambilight saturation.

Ambilight + Hue

Configure

⚙ Settings > All settings > Ambilight > Ambilight+hue > Configure.

Setup your Philips Hue bulbs to follow the colours of Ambilight.



Switch Off

Switch off Ambilight+hue

⚙ Settings > All settings > Ambilight > Ambilight+hue > Switch off.

Immersion

⚙ Settings > All settings > Ambilight > Ambilight+hue > Immersion.

Press the arrows  (up) or  (down) to adjust how accurate the Hue bulbs follow the Ambilight.

Lounge Light+hue

If you installed Ambilight+hue, you can let the hue bulbs follow Lounge Light from Ambilight. The Philips hue lamps will expand the Lounge Light effect across the room.

Switch on/off the hue bulbs

⚙ Settings > All settings > Ambilight > Ambilight+hue > Lounge light+hue.

View Configuration or Reset

View current setup of the Ambilight+hue, network, Bridge and bulbs

⚙ Settings > All settings > Ambilight > Ambilight+hue > View configuration.

Reset current setup of the Ambilight+hue

⚙ Settings > All settings > Ambilight > Ambilight+hue > Reset configuration.

Advanced Ambilight Settings

Neutralise the influence of a coloured wall on the Ambilight colours

⚙ Settings > All settings
> Ambilight > Advanced > Wall colour.

Select the colour of the wall behind the TV and the TV will modify the Ambilight colours to appear as they are intended.

ISF ISF Tuning

⚙ Settings > All settings
> Ambilight > Advanced >  ISF tuning.

Set Ambilight to switch off immediately or slowly fade out when you switch off the TV

⚙ Settings > All settings > Ambilight > Advanced > TV switch off.

14.4

Eco Settings

Set energy saving level

⚙ Settings > All settings > Eco settings > Energy saving.

Select Maximum, Medium, or Minimum to have different degrees for energy saving, or select Off to switch off energy saving mode.

Set screen off to save energy consumption

⚙ Settings > All settings > Eco settings > Screen off.

Select Screen off, the TV screen is switched off, to switch the TV screen back on, press any key on the remote control.



Switch on built-in ambient light sensor

⚙ Settings > All settings > Eco settings > Light sensor.

Select Light sensor, the built-in ambient light sensor lowers the brightness of the TV screen when the surrounding light darkens. The built-in light sensor automatically adjusts the picture, to the lighting conditions of the room.

Set TV switch off timer

⚙ Settings > All settings > Eco settings > Switch off timer.

Press the arrows  (up) or  (down) to adjust the value. The value 0 (Off) deactivates the automatic switch off.

Select Switch off timer, the TV switches off automatically to save energy.

* TV switches off if receiving a TV signal but you don't press a key on the remote control during a 4 hour period.

* TV switches off if not receiving a TV signal nor a remote control command for 10 minutes.

* If you use the TV as a monitor or use a digital receiver to watch TV (a Set-Top Box - STB) and you do not use the remote control of the TV, you should deactivate this automatic switch off, to set the value to 0.

14.5

General Settings

USB Hard Drive

You need to set up and format a USB Hard Drive before you record a channel.

⚙ Settings > All settings > General settings > USB Hard Drive.

Before you can pause or record a broadcast, or store apps, you must connect and format a USB Hard Drive. Formatting removes all files from the USB Hard Drive. If you want to record broadcasts with TV Guide data from the Internet, you must setup the Internet connection first before you install the USB Hard Drive.

Warning

The USB Hard Drive is formatted exclusively for this TV, you cannot use the stored recordings on another TV or PC. Do not copy or change recording files on the USB Hard Drive with any PC application. This will corrupt your recordings. When you format another USB Hard Drive, the content on the former will be lost. A USB Hard Drive installed on your TV will need reformatting for use with a computer.

To format a USB Hard Drive...

- 1 - Connect the USB Hard Drive to one of the **USB** connections on the TV. Do not connect another USB device to the other USB ports when formatting.
- 2 - Switch on the USB Hard Drive and the TV.
- 3 - Select **Recordings** if you want to perform Pause TV and Recordings, otherwise, select **Apps** to store apps. Follow the instructions on screen.
- 4 - All files and data will be removed after formatting.
- 5 - When the USB Hard Drive is formatted, leave it

connected permanently.

USB Keyboard Settings

Set the keyboard layout for installed USB keyboard

⚙ Settings > All settings > General settings > USB keyboard settings.

Connect the USB keyboard to one of the USB connections on this TV. When the TV detects the keyboard for the first time, you can select your keyboard lay-out and test your selection.

Home or Shop

Select the location of your TV

⚙ Settings > All settings > General settings > Location.

Select Shop, the picture style is switched back to Vivid, and can adjust shop settings. Shop mode is for in-store promotion.

Shop Setup

Adjust shop settings

⚙ Settings > All settings > General settings > Shop setup.

If the TV is set to Shop, you can set the availability of a specific demo for in store use.

Adjust Picture and audio

⚙ Settings > All settings > General settings > Shop setup > Picture and audio.

Select **Optimized for shop** or **custom** for picture and audio settings.

Set Logos and banner

⚙ Settings > All settings > General settings > Shop setup > Logos and banner.

Set to display **Feature logos** and **Promotional banner**.

Demo Me autostart and Ambilight Demo autostart

⚙ Settings > All settings > General settings > Shop setup > Demo Me autostart / Ambilight Demo autostart.

Turn On/Off the Demo Me or Ambilight Demo

autostart.

EasyLink – HDMI CEC

Connect HDMI CEC-compatible devices to your TV, you can operate them with the TV remote control.

EasyLink HDMI CEC must be switched on on the TV and the connected device.

Switch on EasyLink

⚙ Settings > All settings > General settings > EasyLink > EasyLink > On.

Operate HDMI CEC-compatible devices with TV remote control

⚙ Settings > All settings > General settings > EasyLink > EasyLink remote control > On.

Note:

- EasyLink might not work with devices from other brands.
- The HDMI CEC functionality has different names on different brands. Some examples are: Anynet, Aquos Link, Bravia Theatre Sync, Kuro Link, Simplink and Viera Link. Not all brands are fully compatible with EasyLink. Example HDMI CEC branding names are property of their respective owners.

HDMI Ultra HD

Connect the HDMI device and play Ultra HD signal on your TV, might not work correctly or show distorted picture or sound. To avoid the malfunctioning of such a device, you can set the signal quality to a level the device can handle.

Set the signal quality for each HDMI connectors

⚙ Settings > All settings > General settings > HDMI Ultra HD > HDMI 1&2 > Standard, Optimal, off.

To change the settings, switch to the HDMI source first. Select **Optimal** to enable the highest quality HDMI signal for 4K Ultra HD and HDR content (4K60 4:4:4, 4K60 10-bit HDR).

Select **Standard** or **Off** if the picture or sound are distorted.

Advanced

TV Guide

The TV Guide receives information (data) from broadcasters or from the Internet. The TV can collect TV Guide information for the channels that are installed on the TV.

Select where the TV guide data receives from

⚙ Settings > All settings > General settings > Advanced > TV guide.

Note:

- In some regions and for some channels, TV guide information might not be available.
- The TV cannot collect the TV guide information from channels viewed from a digital receiver or decoder.

Channel Logos

Switch off channel logos

⚙ Settings > All settings > General settings > Advanced > Channel logos.

HbbTV Settings - Hybrid Broadcast Broadband TV

Switch on HbbTV

⚙ Settings > All settings > General settings > Advanced > HbbTV settings > HbbTV > On.

Switch off HbbTV History Tracking

⚙ Settings > All settings > General settings > Advanced > HbbTV settings > HbbTV tracking > Off.

Remove HbbTV Cookies

⚙ Settings > All settings > General settings > Advanced > HbbTV settings > HbbTV cookies > On.

CAM Profile Name

Set profile name for installed CI+/CAM

⚙ Settings > All settings > General settings > CAM profile name.

Reset TV Settings and Reinstall TV

Reset all settings value to original TV settings

⚙ Settings > All settings > General settings > Factory settings.

Redo full TV installation , and set TV status back to the first time you switch on

⚙ Settings > All settings > General settings > Reinstall TV.

Enter PIN code and select Yes, the TV will reinstall completely.

All settings will be reset and installed channels will be replaced.

The installation can take a few minute

14.6

Clock, Region, and Language Settings

Language

⚙ Settings > All settings > Region and language > Language.

Change the language of the TV menu and messages

⚙ Settings > All settings > Region and language > Language > Menu language.

Set audio preference language

⚙ Settings > All settings > Region and language > Language > Primary audio, Secondary audio.

Digital TV channels can broadcast audio with several spoken languages for a programme. You can set a preferred primary and secondary audio language. If audio in one of these languages is available, the TV will switch to this audio.

Set subtitle preference language

⚙ Settings > All settings > Region and language > Language > Primary subtitle, Secondary subtitle.

Digital channels can offer several subtitle languages for a programme. You can set a preferred primary and secondary subtitle language. If subtitles in one of

these languages are available, the TV will show the subtitles you selected.

Set teletext preference language

⚙ Settings > All settings > Region and language > Language > Primary text, Secondary text.

Some digital TV broadcasters have several Text languages available.

Clock

⚙ Settings > All settings > Region and language > Clock.

Correct clock automatically

⚙ Settings > All settings > Region and language > Clock > Auto clock mode.

- The standard setting for the TV clock is Automatic. The time information comes from the broadcasted UTC - Coordinated Universal Time information.
- If the clock is not correct, you can set the TV clock to Country dependent.

Correct clock manually

⚙ Settings > All settings > Region and language > Clock > Auto clock mode > Manual.

⚙ Settings > All settings > Region and language > Clock > Date, Time.

Go to previous menu, and select Date and Time to adjust the value.

Note:

- If none of the automatic settings display the time correctly, you can set the time manually.
- If you schedule recordings from the TV Guide, we recommend not to change the time and date manually.

Set time zone or set a time offset for your region

⚙ Settings > All settings > Region and language > Clock > Time zone.

Set the TV to switch to Standby automatically after a preset time

⚙ Settings > All settings > Region and language > Clock > Sleep timer.

Remote Control Keyboard

⚙ Settings > All settings > Region and language > Remote control keyboard

To set the keyboard layout to Qwerty or Azerty.

14.7

Android Settings

⚙ Settings > All settings > Android settings.

View the list of installed Apps, check out the free space to download more or uninstall an App.

14.8

Universal Access Settings

⚙ Settings > All settings > Universal access.

With Universal Access switched on, the TV is prepared for use for the deaf, hard of hearing, blind or partially sighted people.

Switch on universal access settings

⚙ Settings > All settings > Universal access > Universal access > On.

Universal access for hearing impaired people

⚙ Settings > All settings > Universal access > Hearing impaired > On.

- Some digital TV channels broadcast special audio and subtitles adapted for the hard of hearing or deaf people.
- Switched on, the TV automatically switches to the adapted audio and subtitles, if available.

Universal access for blind or partially sighted people

⚙ Settings > All settings > Universal access > Audio description > Audio description > On.

Digital TV channels can broadcast special audio commentary describing what is happening on screen.

⚙ Settings > All settings > Universal access > Audio description > Mixed volume, Audio effects, Speech.

- Select Mixed volume, you can mix the volume of the normal audio with the audio commentary. Press the arrows **▲** (up) or **▼** (down) to adjust the value.
- Set Audio effect to On for extra audio effects in

the commentary audio, like stereo or fading sound.

• Select Speech to set speech preference, Descriptive or Subtitles.

14.9

Lock Settings

Set Code and Change Code

Set new code or reset change code

⚙ Settings > All settings > Child lock > Set code, Change code.

The child lock code is used to lock or unlock channels or programmes.

Note:

If you forgot your PIN code, you can override the current code use **8888** and enter a new code.

Lock for Programme

Set a minimum age to watch rated programmes

⚙ Settings > All settings > Child lock > Parental rating.

Lock for App

Set lock on Philips apps

⚙ Settings > All settings > Child lock > App lock.

You can lock apps unsuited for children. You can lock 18+ rated apps from the Philips apps or set up a restricted profile in the Home menu.

18+

The 18+ app lock will ask for a PIN code when you try to start an 18+ rated app. This lock is only valid for 18+ rated apps from the Philips apps.

Restricted profile

You can set up a restricted profile for the Home menu where only the apps you allow are available. You need to enter a PIN code to set up and switch on the restricted profile.

Google Play Store - Maturity

In the Google Play Store, you can hide apps according to users/buyers maturity. You need to enter a PIN code to select or change the level of maturity. The level of maturity will determine which apps are available for installation.

Lock for CAM

Set CAM PIN for recording

⚙ Settings > All settings > Child lock > CAM PIN.

Videos, Photos and Music

From a Computer or NAS





You can view your photos or play your music and videos from a computer or a NAS (Network Attached Storage) in your home network.

The TV and computer or NAS must be in the same home network. On your computer or NAS, you need to install Media Server Software. Your Media Server must be set to share your files with the TV. The TV shows your files and folders as they are organised by the Media Server or as they are structured on your computer or NAS.

The TV does not support subtitles on video streams from a computer or NAS.





If the Media Server supports searching for files, a search field is available.

To browse and play the files on your computer...





- 1 - Press  SOURCES, select  Network and press OK.
- 2 - Select  SimplyShare Devices and press  (right) to select the device you need.
- 3 - Once a SimplyShare device is connected, the SimplyShare Devices item will be replaced by connected device name.
- 4 - You can browse and play your files.
- 5 - To stop playing videos, photos and music, press  EXIT.

Favourites Menu

Add a folder or a file to favourites menu





- 1 - Press  SOURCES, select  USB and press OK.
- 2 - Select  USB Devices and select a folder or a file.
- 3 - Press  Mark favourite (green) to add the selected folder or file to the favourite menu.

View favourite files





- 1 - Press  SOURCES, select  USB and press OK.
- 2 - Select  USB Devices and select  Favourites.
- 3 - You can view all favourite files in the list.

Most Popular Menu and Last Played Menu

View most popular files or clear the list

- 1 - Press  SOURCES, select  USB and press OK.
- 2 - Select  USB Devices and select  Most popular.
- 3 - Select one of the file and press OK to view files or press  Clear all to clear the list.

View last played files









- 1 - Press  SOURCES, select  USB and press OK.
- 2 - Select  USB Devices and select  Last played.
- 3 - Select one of the file and press OK to view files or press  Clear all to clear the list.

From a USB Connection

You can view your photos or play your music and videos from a connected USB flash drive or USB Hard Drive.

With the TV switched on, plug in a USB flash drive or a USB Hard Drive to one of the USB connections. The TV detects the device and will list your media files.

If the list of files does not appear automatically...

- 1 - Press  SOURCES, select  USB and press OK.
- 2 - Select  USB Devices and press  (right) to select the USB device you need.
- 3 - You can browse your files in the folder structure you have organised on the drive.
- 4 - Press  Play all to play all files in the USB folder or press  Mark favourite to add the selected folder to favourite menu -  Favourites.
- 5 - To stop playing videos, photos and music, press  EXIT.







Warning

If you try to pause or record a programme with a USB Hard Drive connected, the TV will ask you to format the USB Hard Drive. This formatting will delete all current files on the USB Hard Drive.







Play your Videos

Play Videos

Open video folder

- 1 - Press  SOURCES, select  USB and press OK.
- 2 - Select  USB Devices and press  (right) to select the USB device you need.
- 3 - Select **Videos**, you can press  **Mark favourite** to add the video folder to favourite menu -  **Favourites**.





Play a video

- 1 - Press  SOURCES, select  USB and press OK.
- 2 - Select  USB Devices and press  (right) to select the USB device you need.
- 3 - Select **Videos** and select one of video, you can press  **Play all** to play all files in the folder or press  **Mark as favourite** to add the selected video to favourite menu -  **Favourites**.

Control bar

To show or hide the control bar when a video is playing, press  **INFO***.



- 1 - Progress bar
- 2 - Playback control bar
 - : Jump to the previous video in a folder
 - : Jump to the next video in a folder
 - : Rewind
 - : Fast forward
 - : Pause the playback
- 3 - Mark as favourites
- 4 - Play all videos
- 5 - Subtitle: switch subtitles On, Off or On During Mute.
- 6 - Subtitle language: select a Subtitle Language
- 7 - Audio language: select an audio language

- 8 - Shuffle: play your files in a random order
- 9 - Repeat: plays all videos in this folder once or continuously

* If  **INFO** key is available on your remote control

Video Options

Browse video files...

- **List/Thumbnails** – List or thumbnails views
- **Shuffle** – Play your files in a random order
- **Repeat** – Plays all videos in this folder once or continuously

- **Info** – Show video information

Playing video files...





- **Mark as favourites** – Mark the video as favourites
- **Subtitle setting** – Set subtitle font size, colour, position...etc

- **Info** – Show video information







View your Photos

View Photos

Open photo folder

- 1 - Press  SOURCES, select  USB and press OK.
- 2 - Select  USB Devices and press  (right) to select the USB device you need.
- 3 - Select **Photos**, you can press  **Mark favourite** to add the photo folder to favourite menu.

View a photo

- 1 - Press  SOURCES, select  USB and press OK.
- 2 - Select  USB Devices and press  (right) to select the USB device you need.
- 3 - Select **Photos** and select one of photos, you can press  **Slide show** to play all files in the folder or press  **Mark favourite** to add the selected photo to favourite menu -  **Favourites**.

Control bar

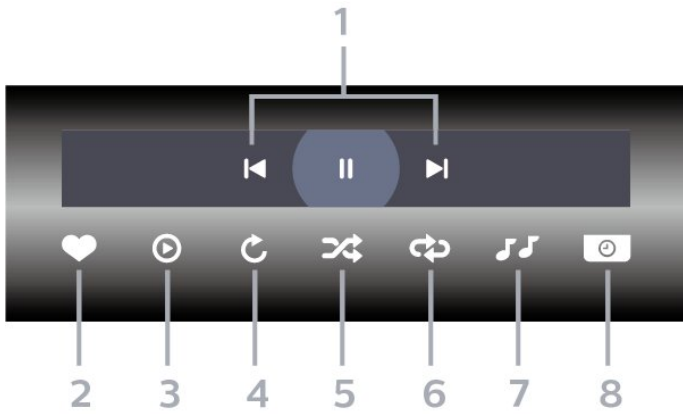

1 - Playback control bar

- ◀: Jump to the previous photo in a folder
- ▶: Jump to the next photo in a folder
- ||: Pause the slideshow playback

2 - Mark as favourites

3 - Start a slideshow

4 - Rotate the photo

5 - Shuffle: play your files in a random order

6 - Repeat: plays all photos in this folder once or continuously

7 - Stop the music playing in the background

8 - Set the speed of the slide show

Photo Options

Browse photo files...

- List/Thumbnails – List or thumbnails views
- Shuffle – Play your files in a random order
- Repeat – Play the slide show once or continuously

- Stop music – Stop background music playing
- Slide Show Speed – Set the speed of the slide show

- Info – Show photo information

Playing photo files...

- Mark as favourites – Mark the photo as favourites
- Info – Show photo information

View 360 Photos

Open 360 Photos folder

1 - Press **SOURCES**, select **USB** and press **OK**.

2 - Select **USB Devices** and press **>** (right) to select the USB device you need.

3 - Select **360 Photos**, you can press **Mark favourite** to add the 360 photos folder to favourite menu.

View a 360 photo

1 - Press **SOURCES**, select **USB** and press **OK**.

2 - Select **USB Devices** and press **>** (right) to select the USB device you need.

3 - Select **360 Photos** and select one of photos, you can press **Slide show** to play all files in the folder or press **Mark favourite** to add the selected photo to favourite menu - **Favourites**.

Control bar

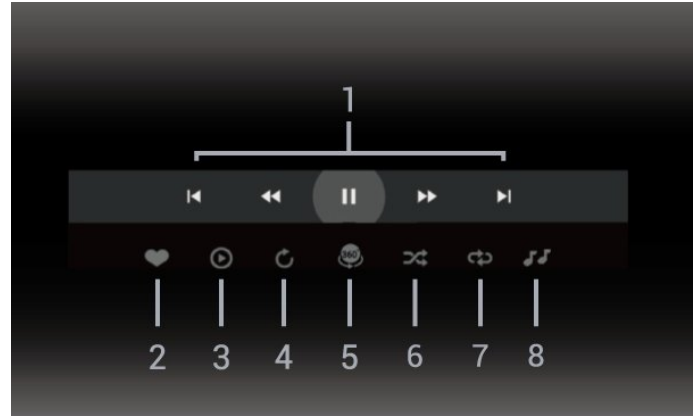

1 - Playback control bar

- ◀: Jump to the previous photo in a folder
- ▶: Jump to the next photo in a folder
- ◀◀: Rewind playback at 2x, 4x, 32x speed
- ▶▶: Wind playback at 2x, 4x, 32x speed
- ||: Pause the playback

2 - Mark as favourites

3 - Play one / Play all: play one photo or play all photos in this folder.

4 - Manual mode /Auto mode: when the 360 player is started, it will auto pan the selected 360 photo from left to right (0 to 360 degrees) in 360 view. When manual mode is entered, the 360 player will stop auto panning/rotating to allow manually panning/rotating with the remote control keys.

5 - Little Planet view: Little Planet is an alternate and fun view of 360 photo. When Little Planet view is started, the 360 photo will be rendered in a wrapped around view like a planet.

6 - Shuffle: play your files in a random order.

7 - Repeat: plays all photos in this folder once or continuously.

8 - Stop the music playing in the background.

360 Photo Options

Browse 360 photo files...

- List/Thumbnails – List or thumbnails views
- Shuffle – Play your files in a random order
- Repeat – Play your files once or continuously
- Stop music – Stop background music playing

Playing 360 photo files...







- Reset view – Rest the angle of view
- Stop music – Stop background music playing
- Info – Show 360 photo information

15.7







Play your Music

Play Music

Open music folder

- 1 - Press , select  USB and press OK.
- 2 - Select  USB Devices and press  (right) to select the USB device you need.
- 3 - Select Music, you can press  Mark favourite to add the music folder to favourite menu
 -  Favourites.
- 4 - You can quickly find a music using classification
 - Genres, Artists, Albums, Tracks.

Play music



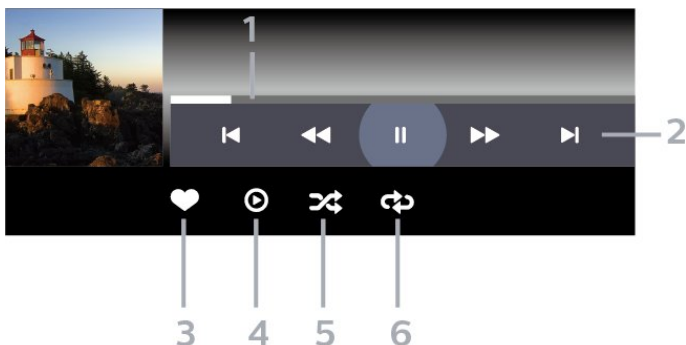

- 1 - Press , select  USB and press OK.
- 2 - Select  USB Devices and press  (right) to select the USB device you need.
- 3 - Select Music and select one of classifications to view music files.
- 4 - Select a music and you can press  Play all to play all files in the folder or press  Mark favourite to add the selected music to favourite menu
 -  Favourites.

Control bar



- 1 - Progress bar

2 - Playback control bar

- : Jump to the previous music in a folder
- : Jump to the next music in a folder
 - : Rewind
 - : Fast forward
 - : Pause the playback

3 - Mark as favourites

4 - Play all music

5 - Shuffle: play your files in a random order

6 - Repeat: plays all music in this folder once or continuously

Music Options

Browse music files...

- Shuffle – Play your files in a random order.

- Repeat – Plays all songs in this folder once or continuously.

Playing music files...

- Mark as favourites – Mark the music as favourites

TV Guide

16.1

What You Need

With the TV Guide you can view a list of the current and scheduled TV programmes of your channels. Depending on where the TV guide information (data) is coming from, analogue and digital channels or only digital channels are shown. Not all channels offer TV Guide information.

The TV can collect TV Guide information for the channels that are installed on the TV. The TV cannot collect the TV Guide information for channels viewed from a digital receiver or decoder.

16.2

TV Guide Data

The TV Guide receives information (data) from broadcasters or from the Internet. In some regions and for some channels, TV Guide information might not be available. The TV can collect TV Guide information for the channels that are installed on the TV. The TV cannot collect the TV Guide information from channels viewed from a digital receiver or decoder.

The TV comes with the information set to **From the Broadcaster**.

If TV Guide information comes from the Internet, the TV Guide can also list analogue channels next to the digital channels. The TV Guide menu also shows a small screen with the current channel.

From the Internet

If the TV is connected to the Internet, you can set the TV to receive the TV Guide information from the Internet.

To set the TV Guide information...

- 1 - Press , select **All Settings** and press **OK**.
- 2 - Select **General Settings** and press **➤** (right) to enter the menu.
- 3 - Select **Advanced > TV Guide > From the Internet** and press **OK**.
- 4 - Press **◀** (left) repeatedly if necessary, to close the menu.

Missing recordings

When some recordings seem to have disappeared from the list of recordings, the TV Guide info (data) might have changed. Recordings made with the setting **From the Broadcaster** become invisible in the list if you switch the setting to **From the**

Internet or vice versa. The TV might have switched to **From the Internet** automatically.

To make the recordings available in the list of recordings, switch to the setting that was selected when the recordings were made.

16.3

Using the TV Guide

Open the TV Guide

To open the TV Guide, press  **TV GUIDE**. The TV Guide shows the channels of the selected tuner.

Press  **TV GUIDE** again to close.

The first time you open the TV Guide, the TV scans all TV channels for programme information. This may take several minutes. TV Guide data is stored on TV.

Tune to a Programme

From the TV Guide, you can tune to a current programme.

To switch to the programme (channel), select the programme and press **OK**.

View programme details

To call up the details of the selected programme...

- 1 - Press  **INFO**.
- 2 - Press  **BACK** to close.

Change Day

The TV Guide can show the scheduled programmes for the upcoming days (maximum up to 8 days).



Press the colour key  **Day** and select the day you need.

Set a Reminder

You can set a reminder for a programme. A message will alert you at the start of the programme. You can tune to this channel immediately.

In the TV Guide a programme with a reminder is marked with a  (clock).

To set a reminder...

- 1 - Press  **TV GUIDE** and select an upcoming programme.
- 2 - Press the colour key  **Set Reminder** and press **OK**.
- 3 - Press  **BACK** to close the menu.

To clear a reminder...

- 1 - Press **TV GUIDE** and select a programme with the reminder.
- 2 - Press the colour key **Clear Reminder** and press **OK**.
- 3 - Press **BACK** to close the menu.

* Note: If a USB Hard drive is connected and ready for recording, the colour key **Set Reminder/Clear Reminder** will be changed to **Record/Clear Recording**. For more information about recording, please refer to "Recording and Pause TV" chapter.

Search by Genre

If the information is available, you can look up scheduled programmes by genre like movies, sports, etc.

To search for programmes by genre...

- 1 - Press **TV GUIDE**.
- 2 - Press **OPTIONS**.
- 3 - Select **Search by Genre** and press **OK**.
- 4 - Select the genre you want and press **OK**. A list with the found programmes appears.
- 5 - You can set reminders or schedule a recording on a selected programme.
- 6 - Press **BACK** to close the menu.

For more information on Recording, press the colour key **Keywords** and look up **Recording**.

* Not available when selecting DVB-S channel

List of Reminders

You can view a list of the reminders you have set.

List of Reminders

To open the list of reminders...

- 1 - Press **TV GUIDE**.
- 2 - Press the colour key **Recordings**.
- 3 - At the top of the screen, select **Scheduled** and press **OK**.
- 4 - In the list of scheduled recordings and reminders, select the tab **Reminders** and press **OK** to view the reminders only.
- 5 - Press the colour key **Remove** to remove the selected reminder. Press the colour key **Record** to record the selected programme.
- 6 - Press **BACK** to close the menu.

Set a Recording

You can set a recording in the TV Guide*.

To see the recording list, press **Recordings**, a programme set to be recorded is marked with a **•** (red dot) on the front of the programme name.

To record a programme...

- 1 - Press **TV GUIDE** and select a future or ongoing programme.
- 2 - Press the colour key **Record**.
- 3 - Press **BACK** to close the menu.

To cancel a recording...

- 1 - Press **TV GUIDE** and select the programme set for recording.
- 2 - Press the colour key **Clear Recording**.
- 3 - Press **BACK** to close the menu.

* See chapter **Recording and Pause TV** for more information.

Recording and Pause TV

17.1

Recording

What You Need

You can record a digital TV broadcast and watch it later.

To record a TV programme you need...

- a connected USB Hard Drive formatted on this TV
- digital TV channels installed on this TV
- to receive channel information for the on screen TV Guide
- a reliable TV clock setting. If you reset the TV clock manually, recordings may fail.

You cannot record when you are using Pause TV.

In terms enforcement of copyright legislation, some DVB providers can apply different restriction by means of DRM (Digital Right Management) technology. In case of broadcasting protected channels, recording, record validity or number of views may be restricted. Recording may be completely prohibited. In case of trying to record a protected broadcasting or play back an expired recording, an error message can appear.

For more information on installing a USB Hard Drive, in **Help**, press the colour key **Keywords** and look up **USB Hard Drive, installation**.

Note:

Recording function is only for digital TV broadcast. It is not possible to record content from external devices (e.g. HDMI).

Record a Programme

Record Now

To record the programme you are watching right now, press **Record** (Record) on the remote control. The recording will start immediately.

To stop the recording, press **Stop** (Stop).

When TV Guide data is available, the programme you are watching will be recorded from the moment you pressed the recording key until the programme ends. If no TV Guide data is available, the recording will only last 30 minutes. You can adjust the end time of the recording in the list of **Recordings**.

Schedule a Recording

You can schedule a recording of an upcoming programme for today or a few days from today (maximum of 8 days away). The TV will use the data from the TV Guide to start and end the recording.

To record a programme...

- 1 - Press **TV GUIDE**.
- 2 - On the TV Guide, select the channel and programme you wish to record. Press **Right** (right) or **Left** (left) to scroll through the programmes of a channel. Use the colour key **Day** to select the day you need.
- 3 - With the programme highlighted, press the colour key **Record**. The programme is scheduled for recording. A warning will show automatically when overlapping recordings are scheduled. If you plan to record a programme in your absence, remember to leave the TV switched to Standby and the USB Hard Drive switched on.
- 4 - The TV adds some time margin at the end of the programme. You can adjust this margin with **Auto End Margin**.
- 5 - Press **BACK** to close the menu.

List of Recordings

You can view and manage your recordings in the list of recordings. Next to the list of recordings, there is a separate list for scheduled recordings and reminders.

To open the list or recordings...

- 1 - Press **TV GUIDE**.
- 2 - Press the colour key **Recordings**.
- 3 - In the list of recordings, select the tabs **New**, **Watched** or **Expired** and press **OK** to filter your view.
- 4 - With a recording selected in the list, you can remove the recording with the colour key **Remove** or stop an ongoing recording with the colour key **Stop Recording**. You can rename a recording with the colour key **Rename**.
- 5 - Press **BACK** to close the menu.

Broadcasters can limit the number of days a recording can be viewed. When this period expires, the recording will be marked as expired. A recording in the list can show the number of days before it expires.

When a scheduled recording was prevented by the broadcaster or when the broadcast was interrupted, a recording is marked as **Failed**.

Recording Conflicts

When two scheduled recordings are overlapping in time, there is a recording conflict. To solve a recording conflict, you can adjust the start and end time of one

or both scheduled recordings.

To adjust the start or end time of a scheduled recording...

- 1 - Press **TV GUIDE**.
- 2 - Press the colour key **Recordings**.
- 3 - At the top of the screen, select **Scheduled** and press **OK**.
- 4 - In the list of scheduled recordings and reminders, select the tab **Recordings** and press **OK** to view the scheduled recordings only.
- 5 - Select the scheduled recording that conflicts with another scheduled recording and press the colour key **Adjust Time**.
- 6 - Select the start or end time and change the time with the **^** (up) or **v** (down) keys. Select **Apply** and press **OK**.
- 7 - Press **← BACK** to close the menu.

Auto End Margin

You can set the time margin that the TV will add automatically at the end of each scheduled recording.

To set the automatic end time margin...

- 1 - Press **TV GUIDE**.
- 2 - Press the colour key **Recordings**.
- 3 - Press **+ OPTIONS** and select **Auto End Margin** and press **OK**.
- 4 - Press **^** (up) or **v** (down) and press **OK** to set the time margin added to a recording automatically. You can add up to 45 minutes to a recording.
- 5 - Press **← BACK** to close the menu.

Manual Recording

You can schedule a recording that is not linked to a TV programme. You set the tuner type, channel and the start and end time yourself.

To schedule a recording manually...

- 1 - Press **TV GUIDE**.
- 2 - Press the colour key **Recordings**.
- 3 - At the top of the screen, select **Scheduled** and press **OK**.
- 4 - Press **+ OPTIONS**, select **Schedule** and press **OK**.
- 5 - Select the tuner from where you want to record and press **OK**.
- 6 - Select the channel to record from and press **OK**.
- 7 - Select the day of the recording and press **OK**.
- 8 - Set the start and end time of the recording. Select a button and use the **^** (up) or **v** (down) keys to set the hours and minutes.
- 9 - Select **Record** and press **OK** to schedule the manual recording.

The recording will appear in the list of scheduled

recordings and reminders.

Watch a Recording

To watch a recording...

- 1 - Press **TV GUIDE**.
- 2 - Press the colour key **Recordings**.
- 3 - In the list of recordings, select the recording you need and press **OK** to start watching.
- 4 - You can use the keys **||** (pause), **▶** (play), **◀◀** (rewind), **▶▶** (fast forward) or **■** (stop).
- 5 - To switch back to watch TV, press **TV EXIT**.

17.2

Pause TV

What You Need

You can pause a digital TV broadcast and resume watching it a bit later.

To pause a TV programme you need...

- a connected USB Hard Drive formatted on this TV
- digital TV channels installed on this TV
- to receive channel information for the on screen TV Guide

With the USB Hard Drive connected and formatted, the TV continuously stores the TV broadcast you are watching. When you switch to another channel, the broadcast of the former channel is cleared. Also when you switch the TV to standby the broadcast is cleared.

You cannot use Pause TV when you are recording.

For more information, in **Help**, press the colour key **Keywords** and look up **USB Hard Drive, installation**.

Pause a Programme

To pause and resume a broadcast...

- To pause a broadcast, press **||** (Pause). A progress bar at the bottom of the screen appears briefly.
- To call up the progress bar, press **||** (Pause) again.
- To resume watching, press **▶** (Play).

With the progress bar on screen, press **◀◀** (Rewind) or press **▶▶** (Forward) to select from where you want to start viewing the paused broadcast. Press these keys repeatedly to change speed.

You can pause a broadcast for a maximum time span of 90 minutes.

To switch back to the live TV broadcast,

press ■ (Stop).

Replay

Since the TV stores the broadcast you are watching, you can mostly replay the broadcast for a few seconds.

To replay a current broadcast...

1 - Press || (Pause)

2 - Press ◀◀ (Rewind). You can press ◀◀ repeatedly to select from where you want to start viewing the paused broadcast. Press these keys repeatedly to change speed. At one point you will reach the start of the broadcast storage or the maximum time span.

3 - Press ▶ (Play) to watch the broadcast again.

4 - Press ■ (Stop) to watch the broadcast live.

Smartphones and Tablets

18.1

Philips TV Remote App

The new Philips TV Remote App on your smartphone or tablet is your new TV buddy.

With the TV Remote App, you master your media around you. Send photos, music or videos to your big TV screen. Look up what you want to watch on the TV Guide and watch it on your TV. With the TV Remote App you can use your phone as a remote control, TV can be switched on or off via your phone.

Download the Philips TV Remote App from your favourite app store today.

The Philips TV Remote App is available for iOS and Android and is free of charge.

18.2

Google Cast

What You Need

If an app on your mobile device has Google Cast, you can cast your app on this TV. On the mobile app, look for the Google Cast icon. You can use your mobile device to control what's on TV. Google Cast works on Android and iOS.

Your mobile device must be connected to the same Wi-Fi home network as your TV.

Apps with Google Cast

New Google Cast apps come available every day. You can already try it with YouTube, Chrome, Netflix, Photowall ... or Big Web Quiz for Chromecast. See also google.com/cast

Some Google Play products and features aren't available in all countries.

Find more information on support.google.com/androidtv

Cast to Your TV

To cast an app to the TV screen...

- 1 - On your smartphone or tablet, open an app that supports Google Cast.
- 2 - Tab the Google Cast icon.
- 3 - Select the TV you would like to cast to.
- 4 - Press play on your smartphone or tablet. What you selected should start playing on TV.

18.3

AirPlay

To add the AirPlay functionality to your Android TV, you can download and install one of the several Android apps that do just that. You can find several of these apps in the Google Play Store.

18.4

MHL

This TV is MHL™ compliant.

If your mobile device is also MHL compliant, you can connect your mobile device with a MHL cable to the TV. With the MHL cable connected you can share what's on your mobile device on the TV screen. Your mobile device charges its battery at the same time. The MHL connection is ideal for watching movies or playing games from your mobile device on TV for a longer time.

Charging

With the MHL cable connected, your device will charge while the TV is switched on (not in standby).

MHL Cable

You need a passive MHL cable (HDMI to Micro USB) to connect your mobile device to the TV. You might need an extra adapter to connect to your mobile device. To connect the MHL cable to the TV use the **HDMI 1 MHL** connection.



MHL, Mobile High-Definition Link and the MHL Logo are trademarks or registered trademarks of the MHL, LLC.

Games

19.1

What You Need

On this TV, you can play games...

- from the Philips TV Collection in the Home menu
- from the Google Play Store in the Home menu
- from a connected Game Console

Games from the Philips TV Collection or the Google Play Store must be downloaded and installed on TV before you can play them. Some games need a gamepad to play.

To install game apps from the Philips TV Collection or the Google Play Store, the TV must be connected to the Internet. You must agree to the Terms of Use to use apps from the Philips TV Collection. You must sign in with a Google Account to use the Google Play apps and Google Play Store.

19.2

Gamepads

To play games from the Internet on this TV, you can connect a selected range of wireless Gamepads. The TV can support 2 connected Gamepads at a time. When you connect the Gamepad, you can use it immediately.

For more information on connecting a gamepad, in **Help**, press the colour key **— Keywords** and look up **Gamepad, connect**.

19.3

Play a Game

From a Game Console

To start a game from a Game Console...

- 1 - Switch on the Game Console.
- 2 - Press **SOURCES** and select a game console or the name of the connection.
- 3 - Start the game.
- 4 - Press **← BACK** repeatedly or press **TV EXIT** or stop the app with its dedicated exit/stop button.

For more information on connecting a Game Console, in **Help**, press the colour key **— Keywords** and look up **Game Console, connect**.

Ambilight

20.1

Ambilight Style

Follow Video

You can set Ambilight to follow the video or the audio dynamics of a TV programme. Alternatively, you can set Ambilight to show a preset colour style or you can switch Ambilight off.

If you select **Follow Video**, you can select one of the styles that follow the dynamics of the picture on your TV screen.

To set the Ambilight Style...

- 1 - Press  **AMBILIGHT**.
- 2 - Select **Follow Video** and press **OK**.
- 3 - Select the style you want and press **OK**.
- 4 - Press **◀** (left) to go back one step or press **←** **BACK** to close the menu.

The available **Follow Video** styles are...

- **Standard** - Ideal for day to day TV watching
- **Natural** - Follows the picture or sound as truthful as possible
- **Football** - Ideal for football games
- **Vivid** - Ideal for daylight conditions

- **Game** - Ideal for gaming
- **Comfort** - Ideal for a quiet evening
- **Relax** - Ideal for a lounge feeling

Follow Audio

You can set Ambilight to follow the video or the audio dynamics of a TV programme. Alternatively, you can set Ambilight to show a preset colour style or you can switch Ambilight off.

If you select **Follow Audio**, you can select one of the styles that follow the dynamics of the sound.

To set the Ambilight Style...

- 1 - Press  **AMBILIGHT**.
- 2 - Select **Follow Audio** and press **OK**.
- 3 - Select the style you want and press **OK**.
- 4 - Press **◀** (left) to go back one step or press **←** **BACK** to close the menu.

The available **Follow Audio** styles are...

- **Lumina** - Mixes audio dynamics with video colours
- **Colora** - Based on audio dynamics
- **Retro** - Based on audio dynamics
- **Spectrum** - Based on audio dynamics
- **Scanner** - Based on audio dynamics

- **Rhythm** - Based on audio dynamics
- **Party** - A mix of all Follow Audio styles, one after the other

Follow Colour

You can set Ambilight to follow the video or the audio dynamics of a TV programme. Alternatively, you can set Ambilight to show a preset colour style or you can switch Ambilight off.

If you select **Follow Colour**, you can select one of the preset colour styles.

To set the Ambilight Style...

- 1 - Press  **AMBILIGHT**.
- 2 - Select **Follow Colour** and press **OK**.
- 3 - Select the style you want and press **OK**.
- 4 - Press **◀** (left) to go back one step or press **←** **BACK** to close the menu.

The available **Follow Colour** styles are...

- **Hot Lava** - Red colour variations
- **Deep Water** - Blue colour variations
- **Fresh Nature** - Green colour variations
-  **Warm white** - Static colour
- **Cool White** - Static colour

Follow Flag

You can set Ambilight to follow the country flag you select.

Follow App

You can set Ambilight to follow the video or the audio dynamics of a TV programme. Alternatively, you can set Ambilight to show a preset colour style or you can switch Ambilight off.

Follow App setting is available when you control Ambilight with an app.

20.2

Ambilight Off

To switch off Ambilight...

- 1 - Press  **AMBILIGHT**.
- 2 - Select **Off** and press **OK**.
- 3 - Press **◀** (left) to go back one step or press **←** **BACK** to close the menu.





Ambilight Settings

For more information, in **Help**, press the colour key **■** **Keywords** and look up **Ambilight, Settings** for more information.

Lounge Light Mode

The lounge light mode of your TV allows you to switch on the Ambilight when the TV is in standby. So you can light up your room with Ambilight.

After you have switched your TV to standby and wish to switch on the Ambilight lounge light, follow these steps:

- 1 - Press  **AMBILIGHT**.
- 2 - After you have pressed the  **AMBILIGHT**, the Ambilight lounge light will be switched on.
- 3 - Press  **AMBILIGHT** again if you wish to change to a different light effect.
- 4 - To switch off the Ambilight lounge light, press  **AMBILIGHT** until you see the lights are turned off. You may need to press  **AMBILIGHT** a few times.

Top Picks

21.1

About Top Picks

With  Top Picks your TV recommends...

- current TV programmes in **Now on TV**
- online TV services (Catch Up TV) in **TV on Demand**
- the latest rental videos in **Video on Demand**
- online TV services (Catch Up TV) from Freeview in **Freeview Play**

To enjoy Top Picks, connect your TV to the Internet. Make sure you agree to the Terms of Use. The Top Picks information and services are only available in selected countries.

Terms of Use

To allow the TV to make these recommendations, you must agree to the Terms of Use. To get personalised recommendations based on your viewing habits, make sure you checked the box for **Personalized Recommendations Service Opt-In**.

To open the Terms of Use...

- 1 - Press  TOP PICKS.
- 2 - Press **+** OPTIONS, select **Terms of Use** and press **OK**.
- 3 - Select **Privacy Settings** and press **OK**.
- 4 - Select **Personalized Recommendations Service Opt-In** and press **OK** to check the box. Press **OK** again to uncheck.
- 5 - Press **←** BACK to close the menu.

21.2

Now on TV

About Now on TV

With  **Now on TV**, the TV recommends the 10 most popular programmes to watch at this moment.

The TV recommends programmes on TV now or starting within 15 minutes. The recommended programmes are selected from the channels you installed. The selection is made from channels of your country. Also, you can let **Now on TV** do some personalised recommendations for you, based on programmes you watch regularly.

To make the Now on TV information available...

- the Now on TV information must be available in your country.
- the TV must have channels installed.
- the TV must be connected to the Internet.
- the TV Clock must be set to Automatic or Country

Dependent.



- you must accept the Terms of Use (You might have accepted already when you connected to the Internet.).

The icon  will only appear at the top of the screen when Now on TV is available.

The TV does not store former recommendations.

Using Now on TV

To open Now on TV...

- 1 - Press  TOP PICKS to open the Top Picks menu.
- 2 - Select  **Now on TV** at the top of the screen and press **OK**.
- 3 - Press **←** BACK to close.

When you open **Now on TV**, the TV may need a few seconds to refresh the page information.

In Now on TV you can...

- select and press **OK** on a programme icon to tune to the ongoing programme.
- select and press **OK** on a scheduled programme icon to tune to the channel already.

You can use the colour keys on the remote control to start, stop or clear a scheduled recording. You can also set or remove a reminder that warns you when a programme starts.

To leave Now on TV without tuning to another channel, press **←** BACK.

21.3

TV on Demand

About TV on Demand





With  **TV on Demand**, you can watch TV programmes you missed or watch your favourite programmes whenever it suits you best. This service is also called Catch Up TV, Replay TV or Online TV. Programmes available on TV on Demand are free to watch.

You can let TV on Demand do some personalised recommendations of programmes, based on the TV installation and the programmes you watch regularly.



The icon  will only appear at the top of the screen when TV on Demand is available.

Using TV on Demand

To open TV on Demand...

- 1 - Press  TOP PICKS to open the Top Picks menu.
- 2 - Select  TV on Demand at the top of the screen and press OK.
- 3 - Press  (down) to open the page full screen.
- 4 - You can select a specific broadcaster if more than one is available.
- 5 - Select a programme icon and press OK to start watching.
- 6 - Press  BACK to close.

When you open TV on Demand, the TV may need a few seconds to refresh the page information.

Once a programme started, you can use the  (Play) and  (Pause) keys.

21.4

Video on Demand

About Video on Demand

With  Video on Demand , you can rent movies from an online rental video store.

You can let Video on Demand do some personalised recommendations of movies, based on your country, the TV installation and the programmes you watch regularly.

The icon  will only appear at the top of the screen when Video on Demand is available.

Payment



When you rent or buy a movie, you can pay the video store securely with your credit card. Most video stores ask you to create a login account the first time you rent a movie.

Internet Traffic

Streaming a lot of videos may cause you to exceed your monthly Internet traffic limit.

Using Video on Demand



To open Video on Demand...

- 1 - Press  TOP PICKS to open the Top Picks menu.
- 2 - Select  Video on Demand at the top of the screen and press OK.
- 3 - Use the navigation keys to select a movie poster.
- 4 - Press  BACK to close.

When you open Video on Demand, the TV may need a few seconds to refresh the page information.

You can select a specific video store if more than one is available.

To rent a movie...

- 1 - Navigate the highlight on a movie poster. Limited info will show after some seconds.
- 2 - Press OK to open the movie page of the video store for a synopsis of the movie.
- 3 - Confirm your order.
- 4 - Make the payment on TV.
- 5 - Start watching. You can use the  (Play) and  (Pause) keys.

Netflix

If you have a Netflix membership subscription, you can enjoy Netflix on this TV. Your TV must be connected to the Internet. In your region, Netflix might only come available with future software updates.

To open Netflix, press **NETFLIX** to open the Netflix App. You can open Netflix immediately from a TV in standby.

www.netflix.com

Alexa

About Alexa

Your TV supports Amazon Alexa voice control operations.

About Alexa

Alexa is a cloud-based voice service available on Alexa Echo devices from Amazon and device manufacturers. With Alexa working on your TV, you can switch on/off TV, change channels, change volume and more.

To control your TV with Alexa, you will need...

- Philips Android Smart TV that supports Alexa
- Amazon Echo device
- Google account
- Mobile device such as your phone or tablet
- Wi-Fi network

About Alexa Skill

Alexa uses the Alexa Skills to extend the voice control operations. Skills add new capabilities that create a more personalised experience with your Alexa enabled TV. "Philips Smart TV Control" skill can be found on Alexa Skills store, it offers various voice control commands to work with your Philips Android Smart TV.

Using Alexa

To use Alexa, you need to first setup the Alexa client service on your Philips Android Smart TV. Start the setup by launching the "Amazon Alexa" app from the Home screen of your TV. Follow the instructions and complete the following steps:

- Select a name for your Android Smart TV for Alexa to recognize.
- Select a Google account and sign-in.
- Return to this skill in the Alexa App on your phone to enable it, link accounts, and discover your devices.
- Return to your TV to complete setup.

Setup on TV for Alexa

- 1 - Press  HOME and open "Amazon Alexa" app.
- 2 - You need Amazon Echo device and Alexa companion app (on mobile device or web version) be ready to start the setup.
- 3 - Follow the instructions on screen to accept Privacy Policy terms, name your TV and sign in your Google account. The Google account is needed to pair with Alexa device.

- 4 - On your mobile device, sign in with the same Google account in the Amazon Alexa companion app.
- 5 - Complete following steps in the Amazon Alexa companion app. The first is to enable "Philips Smart TV Control" skill. The second is to link your Google account and then the final is to discover devices.
- 6 - Select **Enable** or **Disable** for the TV switch on setting. You can use Alexa to turn your TV On/Off by voice command.
- 7 - At the end of setup screen, you can select **Done** to start to use Alexa. Select **Manage TVs** to do the management of Alexa-paired TVs or un-pair the TVs with Alexa.

Go to alexa.amazon.com, click on Skills, and search for "Philips Smart TV Control". The skill will be listed in the results.

Software

24.1

Update Software

Update from Internet

If the TV is connected to the Internet, you may receive a message to update the TV software. You need a high-speed (broadband) Internet connection. If you receive this message, we recommend you to carry out the update.

With the message on screen, select **Update** and follow the instructions on-screen.

You can also look for a software update yourself.

During the software update, there is no picture and the TV will switch off and on again. This might happen several times. The update can take a few minutes. Wait until the TV picture comes back up. Do not press the power switch **⏻** on the TV or on the remote control during the software update.

To look for a software update yourself...

- 1 - Press **⚙️**, select **All Settings** and press **OK**.
- 2 - Select **Update Software > Search for Updates** and press **OK**.
- 3 - Select **Internet** and press **OK**.
- 4 - The TV will look for an update on the Internet.
- 5 - If an update is available, you can update the software right away.
- 6 - A software update can take several minutes. Do not press the **⏻** key on the TV or remote control.
- 7 - When the update is done, the TV will return to the channel you were watching.

Update from USB

It might be necessary to update the TV software.

You need a computer with an high-speed Internet connection and a USB flash drive to upload the software on the TV. Use a USB flash drive with at least 2Gb free space. Make sure that write protection is switched off.

To update the TV software...

- 1 - Press **⚙️**, select **All Settings** and press **OK**.
- 2 - Select **Update Software > Search for Updates** and press **OK**.
- 3 - Select **USB** and press **OK**.

Identify the TV

- 1 - Insert the USB flash drive into one of the USB connections of the TV.
- 2 - Select **Write to USB** and press **OK**. An

identification file is written on the USB flash drive.

Download the software

- 1 - Insert the USB flash drive into your computer.
- 2 - On the USB flash drive, locate the file **update.htm** and double click it.
- 3 - Click **Send ID**.
- 4 - If new software is available, download the .zip file.
- 5 - After the download, unzip the file and copy the file **autorun.upg** onto the USB flash drive. Do not place this file in a folder.

Update the TV software

- 1 - Insert the USB flash drive into the TV again. The update starts automatically.
- 2 - A software update can take several minutes. Do not press the **⏻** key on the TV or remote control. Do not remove the USB flash drive.
- 3 - When the update is done, the TV will return to the channel you were watching.

If a power cut occurs during the update, never remove the USB flash drive from the TV. When the power returns, the update will continue.

To prevent an accidental update of the TV software, delete the **autorun.upg** file from the USB flash drive.

Look for OAD Updates

Scan to search for an OAD (Over-the-air Download) software update.

To look for OAD updates...

- 1 - Press **⚙️**, select **All Settings** and press **OK**.
- 2 - Select **Update Software > Look for OAD updates**.
- 3 - Follow the instructions on screen.

* Note: The OAD software update is only available in selected countries.

24.2

Software Version

To view the current TV software version...

- 1 - Press **⚙️**, select **All Settings** and press **OK**.
- 2 - Select **Update Software > Current Software Info** and press **OK**.
- 3 - The version, release notes and creation date are shown. Also, the Netflix ESN Number is shown if available.
- 4 - Press **⬅️** (left) repeatedly if necessary, to close the menu.

Automatic Software Update

To switch on Automatic software update to update your TV software automatically. Leave the TV in standby.

- 1 - Press , select **All Settings** and press **OK**.
- 2 - Select **Update Software > Automatic Software Update** and press **OK**.
- 3 - Follow the on-screen instruction.
- 4 - Press **◀** (left) repeatedly if necessary, to close the menu.

When the setting is enabled, the upgrade gets downloaded when the TV is powered ON and installed 15min after the TV has gone to standby (as long as there are no recordings or other alarms scheduled).

When the setting is disabled, the "Upgrade Now" / "Later" OSD will be shown.

Open Source Software

This television contains open source software. TP Vision Europe B.V. hereby offers to deliver, upon request, a copy of the complete corresponding source code for the copyrighted open source software packages used in this product for which such offer is requested by the respective licences.

This offer is valid up to three years after product purchase to anyone in receipt of this information. To obtain the source code, please write in English to .

open.source@tpvision.com

Open Source License

About Open Source License

README for the source code of the parts of TP Vision Netherlands B.V. TV software that fall under open source licenses.

This is a document describing the distribution of the source code used on the TP Vision Netherlands B.V. TV, which fall either under the GNU General Public License (the GPL), or the GNU Lesser General Public License (the LGPL), or any other open source license. Instructions to obtain copies of this software can be found in the Directions For Use.

TP Vision Netherlands B.V. MAKES NO WARRANTIES WHATSOEVER, EITHER EXPRESS OR IMPLIED, INCLUDING ANY WARRANTIES OF

MERCHANTABILITY OR FITNESS FOR A PARTICULAR PURPOSE, REGARDING THIS SOFTWARE. TP Vision Netherlands B.V. offers no support for this software. The preceding does not affect your warranties and statutory rights regarding any TP Vision Netherlands B.V. product(s) you purchased. It only applies to this source code made available to you.

Announcements

You can receive an announcement on new TV software available for download or other software related issues.

To read these announcements...

- 1 - Press , select **All Settings** and press **OK**.
- 2 - Select **Update Software > Announcements**, and press **OK**.
- 3 - If there is an announcement, you can read it or select one of the announcements available.
- 4 - Press **◀** (left) repeatedly if necessary, to close the menu.

Specifications

25.1

Environmental

European Energy Label

The European Energy Label informs you on the energy efficiency class of this product. The greener the energy efficiency class of this product is, the lower the energy it consumes.

On the label, you can find the energy efficiency class, the average power consumption of this product in use and the average energy consumption for 1 year. You can also find the power consumption values for this product on the Philips website for your country at www.philips.com/TV

Product Fiche

65OLED973

- Energy Efficiency Class : B
- Visible Screen Size : 164 cm / 65 inch
- On Mode Power Consumption (W) : 192 W
- Annual Energy Consumption (kWh) * : 281 kWh
- Standby Power Consumption (W) ** : 0.3 W
- Display Resolution (Pixels) : 3840 x 2160p

* Energy consumption kWh per year, based on the power consumption of the television operating 4 hours per day for 365 days. The actual energy consumption depends on how the television is used.

** When the TV is turned off with the remote control and no function is active. Power consumption in full standby mode < 0.3W. TV will take several minutes going to full standby.

End of Use

Disposal of your old product and batteries

Your product is designed and manufactured with high quality materials and components, which can be recycled and reused.



When this crossed-out wheeled bin symbol is attached to a product it means that the product is covered by the European Directive 2012/19/EU.



Please inform yourself about the local separate collection system for electrical and electronic products.

Please act according to your local rules and do not dispose of your old products with your normal household waste. Correct disposal of your old product helps to prevent potential negative consequences for the environment and human health.

Your product contains batteries covered by the European Directive 2006/66/EC, which cannot be disposed with normal household waste.



Please find out for yourself about the local rules on separate collection of batteries because correct disposal will help to prevent negative consequences for the environment and human health.

25.2

Power

Product specifications are subject to change without notice. For more specification details of this product, see www.philips.com/TVsupport

Power

- Mains power : AC 220–240V +/-10%
- Ambient temperature : 5°C to 35°C
- Power saving features : Eco mode, Picture mute (for radio), Auto switch-off timer, Eco settings menu.

For power consumption information, see chapter **Product Fiche**.

25.3

Operating System

Android OS :

Android Oreo 8

Reception

- Aerial input : 75 ohm coaxial (IEC75)
- Tuner bands : Hyperband, S-Channel, UHF, VHF
- DVB : DVB-T2, DVB-C (cable) QAM
- Analogue video playback : SECAM, PAL
- Digital video playback : MPEG2 SD/HD (ISO/IEC 13818-2), MPEG4 SD/HD (ISO/IEC 14496-10), HEVC*
- Digital audio playback (ISO/IEC 13818-3)
- Satellite aerial input : 75 ohm F-type
- Input frequency range : 950 to 2150MHz
- Input level range : 25 to 65 dBm
- DVB-S/S2 QPSK, symbol rate 2 to 45M symbols, SCPC and MCPC
- LNB : DiSEqC 1.0, 1 to 4 LNBs supported, Polarity selection 14/18V, Band selection 22kHz, Tone burst mode, LNB current 300mA max

* Only for DVB-T2, DVB-S2

Display Type

Diagonal screen size

- 164 cm / 65 inch

Display resolution

- 3840 x 2160

Display Input Resolution

Video formats

Resolution — Refresh rate

- 480i - 60 Hz
- 480p - 60 Hz
- 576i - 50 Hz
- 576p - 50 Hz
- 720p - 50 Hz, 60 Hz
- 1080i - 50 Hz, 60 Hz
- 1080p - 24 Hz, 25 Hz, 30 Hz
- 2160p - 24 Hz, 25 Hz, 30 Hz, 50 Hz, 60 Hz

Computer formats

Resolutions (amongst others)

- 640 x 480p - 60 Hz
- 800 x 600p - 60 Hz
- 1024 x 768p - 60 Hz
- 1280 x 768p - 60 Hz
- 1360 x 765p - 60 Hz
- 1360 x 768p - 60 Hz
- 1280 x 1024p - 60 Hz
- 1920 x 1080p - 60 Hz
- 3840 x 2160p - 24 Hz, 25 Hz, 30 Hz, 50 Hz, 60 Hz

Connectivity

TV Bottom

- Common Interface slot: CI+/CAM
- USB 1 - USB 2.0
- USB 2 - USB 3.0
- Headphones - Stereo mini-jack 3.5mm
- HDMI 1 in - ARC - MHL - Ultra HD - HDR
- HDMI 2 in - ARC - Ultra HD - HDR
- Audio out - Optical Toslink
- Network LAN - RJ45
- YPbPr, L/R
- HDMI 4 in - ARC
- HDMI 3 in - ARC
- Antenna (75 ohm)
- Satellite tuner

Dimensions and Weights

65OLED973

- without TV stand:

Width 1462.3 mm - Height 849 mm - Depth 47.6 mm - Weight ± 31.5 kg

- with TV stand:

Width 1462.3 mm - Height 907 mm - Depth 268.8 mm - Weight ± 31.5 kg

Sound

- Output power (RMS) : 60W
- Dolby Audio
- DTS-HD Premium Sound™

Multimedia

Connections

- USB 2.0 / USB 3.0
- Ethernet LAN RJ-45
- Wi-Fi 802.11a/b/g/n/ac (built-in)
- BT 4.2 (* Your TV doesn't support Bluetooth subwoofer/speakers/headphones)

Supported USB file systems

- FAT 16, FAT 32, NTFS

Playback formats

- Containers: PS, TS, M2TS, TTS, AVCHD, MP4, M4V, MKV, ASF, AVI, 3GP, Quicktime
- Video Codecs : AVI, MKV, HEVC, H264/MPEG-4 AVC, MPEG-1, MPEG-2, MPEG-4, VP9
- Audio Codecs : AAC, MP3, WAV, WMA (v2 up to v9.2), WMA-PRO (v9 and v10)

- Subtitles :
 - Formats : SRT, SUB, TXT, SMI
 - Character encodings : UTF-8, Central Europe and Eastern Europe (Windows-1250), Cyrillic (Windows-1251), Greek (Windows-1253), Turkish (Windows-1254), Western Europe (Windows-1252)
- Image Codecs : JPEG, GIF, PNG, BMP
- Limitations :
 - Maximum supported total bit rate for a media file is 30Mbps.
 - Maximum supported video bit rate for a media file is 20Mbps.
 - MPEG-4 AVC (H.264) is supported up to High Profile @ L5.1.
 - H.265 (HEVC) is supported upto Main / Main 10 Profile up to Level 5.1

Supported media server software (DMS)

- You can use any DLNA V1.5 certified media server software (DMS class).
- You can use the Philips TV Remote app (iOS and Android) on mobile devices.

Performance may vary, depending on the capabilities of the mobile device and the software used.

Help and Support

26.1

Register your TV

Register your TV and enjoy a range of benefits including full support (including downloads), privileged access to information about new products, exclusive offers and discounts, the chance to win prizes and even participate in special surveys about new releases.



Go to www.philips.com/TVsupport

26.2

Using Help

This TV offers help on screen .

Open Help

Press the  key (blue) to open Help immediately. Help will open on the chapter that is most relevant to what you are doing or what is selected on TV. To look up topics alphabetically, press the colour key  **Keywords**.

To read the Help as a book, select **Book**.

You can also open  **Help** in the TV menu.

Before you execute the Help instructions, close Help. To close Help, press the colour key  **Close**.

For some activities, like Text (Teletext), the colour keys have specific functions and cannot open Help.

TV Help on your tablet, smartphone or computer

To carry out extended sequences of instructions more easily, you can download the TV Help in PDF format to read on your smartphone, tablet or computer. Alternatively, you can print the relevant Help page from your computer.

To download the Help (user manual) go to www.philips.com/TVsupport

 (TV menu) >  Frequent Settings >  Help

You can use more Help functions to diagnose and get more information about your TV.

- **How to** – You can see instructions on how to install channels, sort channels, update TV software, connect external devices and use Smart functions on your TV.
- **Check the TV** – You can check if the picture, sound, Ambilight are working fine.
- **Check the network** – Check the network

connection.

- **Update software** – Check available software updates.
- **User manual** – Read the user manual for TV information.
- **Troubleshooting** – Find a solution for frequent ask questions.
- **Factory settings** – Reset all settings to factory settings.
- **Reinstall TV** – Reinstall and redo the complete TV installation.
- **Contact info** – Show the telephone number or web address for your country or region.

26.3

Troubleshooting

Switch On and Remote Control

The TV does not switch on

- Disconnect the power cable from the power outlet. Wait for one minute then reconnect it.
- Make sure that the power cable is securely connected.

Creaking sound at startup or switch off

When you are switching the TV on, off or to standby, you hear a creaking sound from the TV chassis. The creaking sound is due to the normal expansion and contraction of the TV as it cools and warms up. This does not affect performance.

TV does not respond to the remote control

The TV requires some time to start up. During this time, the TV does not respond to the remote control or TV controls. This is normal behaviour. If the TV continues to be unresponsive to the remote control, you can check if the remote control is working by means of a mobile phone camera. Put the phone in camera mode and point the remote control to the camera lens. If you press any key on the remote control and you notice the infra red LED flicker through the camera, the remote control is working. The TV needs to be checked. If you do not notice the flickering, the remote control might be broken or its batteries are low. This method of checking the remote control is not possible with remote controls which are wirelessly paired with the TV.

The TV goes back to standby after showing the Philips startup screen

When the TV is in standby, a Philips startup screen is displayed, then the TV returns to standby mode. This is normal behaviour. When the TV is disconnected and reconnected to the power supply, the startup screen is displayed at the next startup. To switch on the TV from standby, press  on the remote control

or on the TV.

The standby light keeps on blinking

Disconnect the power cable from the power outlet. Wait 5 minutes before you reconnect the power cable. If the blinking reoccurs, contact Philips TV Consumer Care.

Channels

No digital channels found during the installation

See the technical specifications to make sure that your TV supports DVB-T or DVB-C in your country. Make sure that all cables are properly connected and that the correct network is selected.

Previously installed channels are not in the channel list

Make sure that the correct channel list is selected.

OLED Screen Care

TV Display refreshing

To protect the screen, OLED TV need refreshing process over time.

There are 2 types of refreshing process:

- Normal refreshing: This will take place automatically and it takes about 10 minutes with TV in standby mode.
- Deep refreshing: This will take about 80 minutes and need to be triggered by consumer. During the process, a white color horizontal line will appear on screen for a while.

To allow OLED TV to perform refreshing properly, please adhere to the following:

- For normal refreshing process to take place automatically, always use remote control to switch off TV and keep the TV power plugged.
- When normal refreshing message is shown on TV screen, follow the onscreen recommended instructions.
- For deep refreshing process, trigger this option via **All settings > Picture > Advanced > Clear residual image** and use remote control to switch off TV and keep the TV power plugged for at least 80 minutes.
- Do not touch or apply pressure on TV screen during the refreshing process.

Special Care for OLED TV

Organic LED (OLED) may experience on-screen image retention (due to the characteristics of the material), when an image is continuously displayed for a long period of time or the same image is repeatedly displayed. So it is strongly recommended

to follow the instructions to take care of OLED TV:

- Do not display any still image continuously or display the same image for more than 10 minutes.
- Recommend to use **Standard** or **HDR Standard** as picture style in normal home viewing condition.
- Recommend to use **OLED Contrast** setting 50 or below in picture settings when playing Game or watching TV programs with logos or clocks on any parts of the screen.
- Switch off On Screen Display (e.g. the home menus) of TV application program when not used.
- Switch off On Screen Display from connected external video devices (e.g. DVD player). For details, refer to the instruction manuals for the connected devices.
- Avoid displaying video with bright colors (including white), text, clocks or logos on any parts of the screen for a long time.
- Use **Wide screen** or **Fill screen** as picture format option (see TV picture settings).
- Always watch video in full screen instead of a small window on TV screen. (e.g. video in internet browser page)

Philips TV is equipped with the following to take care of OLED screen:

- **Pixel shift**
Constantly shift pixels position over time to reduce pixel stress.
- **Automatic refreshing process**
Perform screen refreshing process when necessary.
- **Automatic screen brightness control**
Gradually reduce the screen brightness when still image is displayed for a long time.
- **Screen Saver**
Display screen saver when still image is displayed on screen over a longer period of time.

Picture

No picture / distorted picture

- Make sure that the antenna is properly connected to the TV.
- Make sure that the correct device is selected as the display source.
- Make sure that the external device or source is properly connected.

Sound but no picture

- Make sure that the picture settings are set correctly.

Poor antenna reception

- Make sure that the antenna is properly connected to the TV.
- Loud speakers, unearthed audio devices, neon lights, high buildings and other large objects can influence reception quality. If possible, try to improve the reception quality by changing the antenna direction or moving devices away from the TV.
- If reception on only one channel is poor, fine-tune

this channel with Manual Installation.

Poor picture from a device

- Make sure that the device is connected properly.
- Make sure that the picture settings are set correctly.

Picture settings change after a while

Make sure that **Location** is set to **Home**. You can change and save settings in this mode.

A commercial banner appears

Make sure that **Location** is set to **Home**.

Picture does not fit the screen

Change to a different picture format.

Picture position is incorrect

Picture signals from some devices may not fit the screen correctly. Check the signal output of the connected device.

Computer picture is not stable

Make sure that your PC uses the supported resolution and refresh rate.

Sound

No sound or poor sound quality

If no audio signal is detected, the TV automatically switches the audio output off — this does not indicate malfunction.

- Make sure that the sound settings are correctly set.
- Make sure that all cables are properly connected.
- Make sure that the volume is not muted or set to zero.
- Make sure that the TV audio output is connected to the audio input on the Home Theatre System. Sound should be heard from the HTS speakers.
- Some devices may require you to manually enable HDMI audio output. If HDMI audio is already enabled, but you still do not hear audio, try changing the digital audio format of the device to PCM (Pulse Code Modulation). Refer to the documentation accompanying your device for instructions.

HDMI and USB

HDMI

- Note that HDCP (High-bandwidth Digital Content Protection) support can delay the time taken for a TV to display content from an HDMI device.
- If the TV does not recognise the HDMI device and no picture is displayed, switch the source from one device to another and back again.
- If the picture and sound of a device connected to **HDMI 3** or **HDMI 4** is distorted, connect the

device to **HDMI 1** or **HDMI 2** on this TV.

- If the picture and sound of a device connected with HDMI is distorted, check if a different **HDMI Ultra HD** setting can solve this problem. In Help, press the colour key **— Keywords** and look up **HDMI Ultra HD**.
- If there are intermittent sound disruptions, make sure that output settings from the HDMI device are correct.
- If you use an HDMI-to-DVI adapter or HDMI-to-DVI cable, make sure that an additional audio cable is connected to AUDIO IN (mini-jack only), if available.

HDMI EasyLink does not work

- Make sure that your HDMI devices are HDMI-CEC compatible. EasyLink features only work with devices that are HDMI-CEC compatible.

No volume icon shown

- When an HDMI-CEC audio device is connected and you use the TV Remote Control to adjust the volume level from the device, this behaviour is normal.

Photos, videos and music from a USB device do not show

- Make sure that the USB storage device is set to Mass Storage Class compliant, as described in the storage device's documentation.
- Make sure that the USB storage device is compatible with the TV.
- Make sure that the audio and picture file formats are supported by the TV.

Choppy playback of USB files

- The transfer performance of the USB storage device may limit the data transfer rate to the TV which causes poor playback.

Network

Wi-Fi network not found or distorted

- Microwave ovens, DECT phones or other Wi-Fi 802.11b/g/n devices in your proximity might disturb the wireless network.
- Make sure that the firewalls in your network allow access to the TV's wireless connection.
- If the wireless network does not work properly in your home, try the wired network installation.

Internet does not work

- If the connection to the router is OK, check the router connection to the Internet.

The PC and Internet connection are slow

- Look in your wireless router's user manual for information on indoor range, transfer rate and other factors of signal quality.
- Use a high-speed (broadband) Internet connection for your router.





DHCP

- If the connection fails, you can check the DHCP (Dynamic Host Configuration Protocol) setting of the router. DHCP should be switched on.

Wrong Menu Language

Wrong menu language

Change the language back to your language.

- 1 - Press  HOME to go to Home screen .
- 2 - Select the  icon (Settings) from System bar on the top of Home screen and press OK.
- 3 - Press 5 times  (down).
- 4 - Press 3 times  (right), select your language and press OK.
- 5 - Press  BACK to close the menu.

26.4

Online Help

To solve any Philips TV related problem, you can consult our online support. You can select your language and enter your product model number.

Go to www.philips.com/TVsupport

On the support site you can find your country's telephone number to contact us as well as answers to frequently asked questions (FAQs). In some countries, you can chat with one of our collaborators and ask your question directly or send a question by email. You can download new TV software or the manual to read on your computer.

26.5

Support and Repair

For support and repair, call the Consumer Care hotline in your country. Our service engineers will take care of a repair, if necessary.

Find the telephone number in the printed documentation that came with the TV.
Or consult our website www.philips.com/TVsupport and select your country if needed.

TV model number and serial number

You might be asked to provide the TV product model number and serial number. Find these numbers on the packaging label or on the type label on the back or bottom of the TV.

Warning

Do not attempt to repair the TV yourself. This may cause severe injury, irreparable damage to your TV or void your warranty.

Safety and Care

27.1

Safety

Important

Read and understand all safety instructions before you use the TV. If damage is caused by failure to follow instructions, the warranty does not apply.

Risk of Electric Shock or Fire

- Never expose the TV to rain or water. Never place liquid containers, such as vases, near the TV. If liquids are spilt on or into the TV, disconnect the TV from the power outlet immediately. Contact Philips TV Consumer Care to have the TV checked before use.
- Never expose the TV, remote control or batteries to excessive heat. Never place them near burning candles, naked flames or other heat sources, including direct sunlight.
- Never insert objects into the ventilation slots or other openings on the TV.
- Never place heavy objects on the power cord.
- Avoid force coming onto power plugs. Loose power plugs can cause arcing or fire. Ensure that no strain is exerted on the power cord when you swivel the TV screen.
- To disconnect the TV from the mains power, the power plug of the TV must be disconnected. When disconnecting the power, always pull the power plug, never the cord. Ensure that you have full access to the power plug, power cord and outlet socket at all times.

Risk of Injury or Damage to the TV

- Two people are required to lift and carry a TV that weighs more than 25 kg or 55 lbs.
- If you mount the TV on a stand, only use the supplied stand. Secure the stand to the TV tightly. Place the TV on a flat, level surface that can support the weight of the TV and the stand.
- When wall mounted, ensure that the wall mount can safely bear the weight of the TV set. TP Vision bears no responsibility for improper wall mounting that results in accident, injury or damage.
- Parts of this product are made of glass. Handle with care to avoid injury or damage.

Risk of damage to the TV !

Before you connect the TV to the power outlet,

ensure that the power voltage matches the value printed on the back of the TV. Never connect the TV to the power outlet if the voltage is different.

Risk of Injury to Children

Follow these precautions to prevent the TV from toppling over and causing injury to children:

- Never place the TV on a surface covered by a cloth or other material that can be pulled away.
- Ensure that no part of the TV hangs over the edge of the mounting surface.
- Never place the TV on tall furniture, such as a bookcase, without anchoring both the furniture and TV to the wall or a suitable support.
- Teach children about the dangers of climbing on furniture to reach the TV.

Risk of swallowing batteries !

The remote control may contain coin-type batteries which can easily be swallowed by small children. Keep these batteries out of reach of children at all times.

Risk of Overheating

Never install the TV in a confined space. Always leave a space of at least 10 cm or 4 inches around the TV for ventilation. Ensure curtains or other objects never cover the ventilation slots on the TV.

Lightning Storms

Disconnect the TV from the power outlet and antenna before lightning storms. During lightning storms, never touch any part of the TV, power cord or antenna cable.

Risk of Hearing Damage

Avoid using earphones or headphones at high volumes or for prolonged periods of time.

Low Temperatures

If the TV is transported in temperatures below 5°C or 41°F, unpack the TV and wait until the TV temperature reaches room temperature before connecting the TV to the power outlet.

Humidity

In rare occasions, depending on temperature and humidity, minor condensation can occur on the inside of the TV glass front (on some models). To prevent this, do not expose the TV to direct sunlight, heat or extreme humidity. If condensation occurs, it will disappear spontaneously while the TV is playing for a few hours.

The condensation moisture will not harm the TV or cause malfunction.

27.2

Screen Care

- Never touch, push, rub or strike the screen with any object.
- Unplug the TV before cleaning.
- Clean the TV and frame with a soft damp cloth and wipe gently. Avoid touching the Ambilight LEDs on the backside of the TV. Never use substances such as alcohol, chemicals or household cleaners on the TV.
- To avoid deformations and colour fading, wipe off water drops as quickly as possible.
- Avoid stationary images as much as possible.

Stationary images are images that remain onscreen for extended periods of time. Stationary images include onscreen menus, black bars, time displays, etc. If you must use stationary images, reduce screen contrast and brightness to avoid screen damage.

Terms of Use

28.1

Terms of Use – TV

2018 © TP Vision Europe B.V. All rights reserved.

This product was brought to the market by TP Vision Europe B.V. or one of its affiliates, hereinafter referred to as TP Vision, which is the manufacturer of the product. TP Vision is the warrantor in relation to the TV with which this booklet was packaged. Philips and the Philips Shield Emblem are registered trademarks of Koninklijke Philips N.V.

Specifications are subject to change without notice. Trademarks are the property of Koninklijke Philips N.V or their respective owners. TP Vision reserves the right to change products at any time without being obliged to adjust earlier supplies accordingly.

The written material packaged with the TV and the manual stored in the memory of the TV or downloaded from the Philips website www.philips.com/TVsupport are believed to be adequate for the intended use of the system.

The material in this manual is believed adequate for the intended use of the system. If the product, or its individual modules or procedures, are used for purposes other than those specified herein, confirmation of their validity and suitability must be obtained. TP Vision warrants that the material itself does not infringe any United States patents. No further warranty is expressed or implied. TP Vision cannot be held responsible neither for any errors in the content of this document nor for any problems as a result of the content in this document. Errors reported to Philips will be adapted and published on the Philips support website as soon as possible.

Terms of warranty – Risk of injury, damage to TV or void of warranty!

Never attempt to repair the TV yourself. Use the TV and accessories only as intended by the manufacturer. The caution sign printed on the back of the TV indicates risk of electric shock. Never remove the TV cover. Always contact Philips TV Customer Care for service or repairs. Find the telephone number in the printed documentation that came with the TV. Or consult our website www.philips.com/TVsupport and select your country if needed. Any operation expressly prohibited in this manual, or any adjustments and assembly procedures not recommended or authorised in this manual, shall void the warranty.

Pixel characteristics

This TV product has a high number of colour pixels. Although it has effective pixels of 99.999% or more,

black dots or bright points of light (red, green or blue) may appear constantly on the screen. This is a structural property of the display (within common industry standards) and is not a malfunction.

CE compliance

Hereby, TP Vision Europe B.V. declares that this television is in compliance with the essential requirements and other relevant provisions of Directives 2014/53/EU (RED), 2009/125/EC (Eco Design) and 2011/65/EC (RoHS).

Compliance with EMF

TP Vision manufactures and sells many products targeted at consumers which, like any electronic apparatus, in general have the ability to emit and receive electromagnetic signals. One of TP Vision's leading business principles is to take all necessary health and safety measures for our products, to comply with all applicable legal requirements and to stay well within the Electro Magnetic Field (EMF) standards applicable at the time of producing the products.

TP Vision is committed to developing, producing and marketing products that cause no adverse health effects. TP Vision confirms that, as long as its products are handled properly for their intended use, they are safe to use according to scientific evidence available today. TP Vision plays an active role in the development of international EMF and safety standards, enabling TP Vision to anticipate further developments in standardisation for early integration in its products.

28.2

Terms of Use – Smart TV

You can see the terms of use, privacy policy, and also set privacy settings of your Smart TV.

To open the terms of use of Smart TV page...

- 1 – Press  HOME to open the Home menu.
- 2 – Select **Apps** to open apps.

28.3

Terms of Use – Philips TV Collection

In Help, press the colour key  **Keywords** and look up **Terms of Use, Philips TV Collection** for more information.

Copyrights

29.1

MHL

MHL

MHL, Mobile High-Definition Link and the MHL Logo are trademarks or registered trademarks of the MHL, LLC.



29.2

HDMI

HDMI

The terms HDMI and HDMI High-Definition Multimedia Interface, and the HDMI Logo are trademarks or registered trademarks of HDMI Licensing LLC in the United States and other countries.



29.3

Dolby Audio

Manufactured under license from Dolby Laboratories. Dolby, Dolby Audio, and the double-D symbol are trademarks of Dolby Laboratories.



DTS-HD Premium Sound™

DTS-HD Premium Sound™

For DTS patents, see <http://patents.dts.com>. Manufactured under license from DTS Licensing Limited. DTS, the Symbol, & DTS and the Symbol together are registered trademarks, and DTS Premium Sound is a trademark of DTS, Inc. © DTS, Inc. All Rights Reserved.



29.5

Wi-Fi Alliance

Wi-Fi

Wi-Fi®, the Wi-Fi CERTIFIED logo, the Wi-Fi logo are registered trademarks of the Wi-Fi Alliance.



29.6

Kensington

Kensington

(If applicable)

Kensington and Micro Saver are registered US trademarks of ACCO World Corporation with issued registrations and pending applications in other countries throughout the world.



Other Trademarks

All other registered and unregistered trademarks are the property of their respective owners.

Disclaimer regarding services and/or software offered by third parties

Services and/or software offered by third parties may be changed, suspended, or terminated without prior notice. TP Vision does not bear any responsibility in these sorts of situations.

Index

A

Age Rating 13
Alexa 74
Ambilight+hue, configuration 52
Ambilight+hue, Immersion 52
Ambilight+hue, on or off 52
Ambilight, Ambilight Style 69
Ambilight, Settings 51
Android Settings 35
Announcements 76
Antenna, Manual Installation 24
APP lock 38
Apps 37
Audio Language 14
Audio Language, Primary 14
Audio Language, Secondary 14
Auto Volume Levelling 50
Automatic Channel Update 22

B

Blu-ray Disc player, connect 28
Bluetooth, Pairing 29
Bluetooth, Remove device 29
Bluetooth, Select device 29

C

CAM, Conditional Access Module 27
Channel 12
Channel List 12
Channel List Copy 24
Channel List Copy, copy 24
Channel List Copy, current version 25
Channel List Copy, upload 25
Channel List, about 12
Channel List, filter 12
Channel List, open 12
Channel List, search 12
Channel logos 55
Channel Update Message 22
Channel, age rating 13
Channel, Antenna Installation 22
Channel, Automatic Channel Update 22
Channel, Installation 22
Channel, Manual channel update 22
Channel, Options 13
Channel, Reinstall 22
Channel, Satellite Installation 19
Channel, switch to a channel 13
Channel, TV guide 62
Child Lock 57
Child Lock, App Lock 57
CI+ 27
Clear, Internet memory 34
Colour, colour control 47
Colour, Colour gamut 46
Common Interface Slot 27
Computer, connect 32
Connectivity Guide 26
Consumer Care 83
Contact Philips 83
Contrast, Dynamic Contrast 48

D

Digital Text 16
Disposal of TV or batteries 77
DVB (Digital Video Broadcast) 23

E

EasyLink HDMI CEC 54
Eco Settings 53
End of use 77
European Ecolabel 77

F

Frequency Scan 23
Frequency Step Size 23

G

Game Console, connect 30
Gamepad, connect 29
Gaming 68

H

Hard of hearing 56
HbbTV 18
HDMI MHL 26
HDMI Ultra HD 54
Home 35
Home Theatre System, problems 28
Hue Bridge 52
Hue Bulbs 52

I

Interactive TV 18
Interactive TV, about 17

I

iTV 17

K

Keys on TV 11

L

Lounge Light 70

M

Manual Installation 24
Media 58
Media files, from a computer or NAS 58
Media files, from a USB drive 58
MPEG Artefact Reduction 48

N

Network Frequency 23
Network Frequency Mode 23
Network Installation 33
Network name 34
Network, connect 33
Network, setting 34
Network, Wired 34
Network, Wireless 33
Now on TV 71

O

On or Standby 11
Online support 83

Open Source software 76
Options on a Channel 13

P

Parental Rating 13
Partially sighted 56
Pause TV 64
Photos, Videos and Music 58
Picture Style 46
Picture, picture format 49
Picture, quick settings 50
Power connection 5
Power consumption check 53
Problems, Channels 81
Problems, Connection, Internet 82
Problems, Connection, Wi-Fi 82
Problems, HDMI Connection 82
Problems, Picture 81
Problems, Remote control 80
Problems, Sound 82
Problems, USB Connection 82
Problems, Wrong menu language 83
Product Fiche 77
Programmes, Recommendations 71

R

Radio stations 12
Reception Quality 23
Recording 64
Recording, TV Guide data 62
Register your product 80
Reinstall TV 22
Remote control and batteries 9
Repair 83

S

Safety Instructions 84
Satellite CAMs 19
Satellite Installation 19
Satellite, Add Satellite 20
Satellite, Channel packages 20
Satellite, Manual Channel Update 20
Satellite, Manual Installation 21
Satellite, Remove Satellite 21
Satellite, Unicable 20
Screen care 85
Sharpness, MPEG Artefact Reduction 48
Smart Card, CAM 27
Software, Update 75
Sound Style 50
Subtitle 14
Subtitle Language 14
Subtitle Language, Primary 14
Subtitle Language, Secondary 14
Support, online 83
Switching On 11

T

Teletext 16
Terms of Use 86
Terms of Use, Philips TV Collection 36
Test Reception 23
Text 16
Text language, Primary 17
Text language, Secondary 17
Troubleshooting 80
TV Guide 62
TV Guide, data and information 62

TV Guide, Reminder 62
TV Installation 22
TV on Demand 71
TV placement 5

U

Unicable 20
Universal Access 56
USB Hard Drive, disk space 30
USB Keyboard 31
USB Keyboard, connect 31

V

Video on Demand 72
Viewing distance 5

W

Watch TV 13
Wi-Fi 33
Wired Network 34
Wireless Network 33



All registered and unregistered trademarks are property of their respective owners.
Specifications are subject to change without notice.
Philips and the Philips' shield emblem are trademarks of Koninklijke Philips N.V.
and are used under license from Koninklijke Philips N.V.
2018 © TP Vision Europe B.V. All rights reserved.

philips.com