

Register your product and get support at

www.philips.com/welcome

4000 Series
39PHT4002S/70

User manual

Panduan pengguna

Diproduksi oleh:
PT.TRIDHARMA KENCANA
JL. K.H ZAINUL ARIFIN NO.1
JAKARTA PUSAT

No Pendaftaran Petunjuk Penggunaan
dan Kartu Garansi:

PHILIPS



Environmental Protection Use Period

English

This logo labelled on the product itself indicates that the Environmental Protection Use Period thereof is 10 years.

The Environmental Protection Use Period of electrical information products refers to the time period during which the toxic and hazardous substances or elements contained within the product will not leak or suddenly spoil, and users of such products will not cause any serious environmental pollution or serious damage to human and property.

During the Environmental Protection Use Period, please use this product according to the instructions given in this user manual.

The Environmental Protection Use Period does not cover consumable parts: the battery.

Suggestive description of the Recycling Administrative Regulations for Waste Electrical and Electronics Products

In order to care and protect the Earth in a better way, please adhere to the national and applicable laws in relation to the recycling management of waste electrical and electronics products when the user no longer needs to use this product, or when it has reached the end of its product life.

Contents

1	Caution	2	7	Troubleshooting	12
				General issues	12
				Channel issues	12
				Picture issues	12
				Sound issues	13
				HDMI connection issues	13
				Computer connection issues	13
				Contact us	13
2	Important	3			
3	Your TV	5			
	Control Panel	5			
	Remote Control	5			
	Remote control usage	6			
4	Use your TV	7			
	Switch TV on or off	7			
	Switch channels	7			
	Watch connected devices	7			
	Adjust TV volume	8			
	PC Setting	8			
5	TV Operation	8			
	Channel Settings	8			
	LOCK	9			
	Time Setting	9			
	Settings	9			
	USB Media Function	10			
6	Product information	11			
	Display resolutions	11			
	Multimedia	11			
	Sound power	11			
	Inherent resolution	11			
	Tuner / Reception / Transmission	11			
	Remote Control	11			
	Power Supply	11			
	Supported TV mounts	11			

1 Caution

2017© TP Vision Europe B.V. All rights reserved. Specifications are subjected to change without notice. Trademarks are the property of Koninklijke Philips N.V or their respective owners. TP Vision Europe B.V. reserves the right to change products at any time without being obliged to adjust earlier supplies accordingly. The material in this manual is believed adequate for the intended use of the system. If the product, or its individual modules or procedures, are used for purposes other than those specified herein, confirmation of their validity and suitability must be obtained. TP Vision Europe B.V. warrants that the material itself does not infringe any United States patents. No further warranty is expressed or implied.

TP Vision Europe B.V. cannot be held responsible neither for any errors in the content of this document nor for any problems as a result of the content in this document. Errors reported to Philips will be adapted and published on the Philips support website as soon as possible.

Terms of warranty

- Risk of injury, damage to TV or void of warranty! Do not attempt to repair the TV yourself.
- Use the TV and accessories only as intended by the manufacturer.
- The caution sign printed on the back of the TV indicates risk of electric shock. Never remove the TV cover. Always contact Philips Customer Support for service or repairs.



Any operation expressly prohibited in this

manual, or any adjustments and assembly procedures not recommended or authorised in this manual shall void the warranty.

Pixel characteristics

This LCD/LED product has a high number of color pixels. Although it has effective pixels of 99.999% or more, black dots or bright points of light (red, green or blue) may appear constantly on the screen. This is a structural property of the display (within common industry standards) and is not a malfunction.

Mains fuse (/56)

This TV is fitted with an approved moulded plug. Should it become necessary to replace the mains fuse, this must be replaced with a fuse of the same value as indicated on the plug (example 10A).

- 1 Remove fuse cover and fuse.
- 2 The replacement fuse must comply with BS 1362 and have the ASTA approval mark. If the fuse is lost, contact your dealer in order to verify the correct type.
- 3 Refit the fuse cover.

2 Important

Read and understand all instructions before you use your TV. If damage is caused by failure to follow instructions, the warranty does not apply.

Safety

Risk of electric shock or fire!

- Never expose the TV to rain or water. Never place liquid containers, such as vases, near the TV. If liquids are spilt on or into the TV, disconnect the TV from the power outlet immediately. Contact Philips Consumer Care to have the TV checked before use.
- Never place the TV, remote control or batteries near naked flame or rather heat sources, including direct sunlight. To prevent the spread of fire, keep candles or other flames away from the TV, remote control and batteries at all times.



- Never insert objects into the ventilation slots or other openings on the TV.
- When the TV is swivelled ensure that no strain is exerted on the power cord. Strain on the power cord can loosen connections and cause arcing.
- To disconnect the TV from the mains power, the power plug of the TV must be disconnected. When disconnecting the power, always pull the power plug, never the cord. Ensure that you have full access to the power plug, power cord and outlet socket at all times.

Risk of short circuit or fire!

- Never expose the remote control or batteries to rain, water or excessive heat.
- Avoid force coming onto power plugs. Loose power plugs can cause arcing or fire.

Risk of injury or damage to the TV!

- Two people are required to lift and carry a TV that weighs more than 25 kg or 55 lbs.
- When stand mounting the TV, use only the supplied stand. Secure the stand to the TV tightly. Place the TV on a flat, level surface that can support the combined weight of the TV and the stand.
- When wall mounting the TV, use only a wall mount that can support the weight of the TV. Secure the wall mount to a wall that can support the combined weight of the TV and wall mount. TP Vision Europe B.V. bears no responsibility for improper wall mounting that results in accident, injury or damage.
- If you need to store the TV, disassemble the stand from the TV. Never lay the TV on its back with the stand installed.
- Before you connect the TV to the power outlet, ensure that the power voltage matches the value printed on the back of the TV. Never connect the TV to the power outlet if the voltage is different.
- Parts of this product may be made of glass. Handle with care to avoid injury and damage.

Risk of injury to children!

Follow these precautions to prevent the TV from toppling over and causing injury to children:

- Never place the TV on a surface covered by a cloth or other material that can be pulled away.
- Ensure that no part of the TV hangs over the edge of the surface.
- Never place the TV on tall furniture (such as a bookcase) without anchoring both the furniture and TV to the wall or a suitable support.
- Educate children about the dangers of climbing on furniture to reach the TV.

Risk of swallowing batteries!

- The product/remote control may contain a coin-type battery, which can be swallowed. Keep the battery out of reach of children at all times!

Risk of overheating!

- Never install the TV in a confined space. Always leave a space of at least 4 inches or 10 cm around the TV for ventilation. Ensure curtains or other objects never cover the ventilation slots on the TV.

Risk of injury, fire or power cord damage!

- Never place the TV or any objects on the power cord.
- Disconnect the TV from the power outlet and antenna before lightning storms. During lightning storms, never touch any part of the TV, power cord or antenna cable.

Risk of hearing damage!

- Avoid using earphones or headphones at high volumes or for prolonged periods of time.

Low temperatures

- If the TV is transported in temperatures below 5 °C or 41 °F, unpack the TV and wait until the TV temperature matches room temperature before connecting the TV to the power outlet.

Screen care

- Avoid stationary images as much as possible. Stationary images are images that remain on-screen for extended periods of time. Example: on-screen menus, black bars and time displays. If you must use stationary images, reduce screen contrast and brightness to avoid screen damage.
- Unplug the TV before cleaning.
- Clean the TV and frame with a soft, damp cloth. Never use substances such as alcohol, chemicals or household cleaners on the TV.

- Risk of damage to the TV screen! Never touch, push, rub or strike the screen with any object.
- To avoid deformations and color fading, wipe off water drops as soon as possible.

Recycling

Your product is designed and manufactured with high quality materials and components, which can be recycled and reused.



When this crossed-out wheeled bin symbol is attached to a product it means that the product is covered by the European Directive 2002/96/EC. Please inform yourself about the local separate collection system for electrical and electronic products.

Please act according to your local rules and do not dispose of your old products with your normal household waste.

Correct disposal of your old product helps to prevent potential negative consequences for the environment and human health.



Your product contains batteries covered by the European Directive 2006/66/EC, which cannot be disposed of with normal household waste. Please inform yourself about the local rules on separate collection of batteries because correct disposal helps to prevent negative consequences for the environment and human health.

3 Your TV

Congratulations on your purchasing, and welcome to Philips! To fully benefit from the support that Philips offers, register your TV at www.philips.com/welcome.

Control Panel

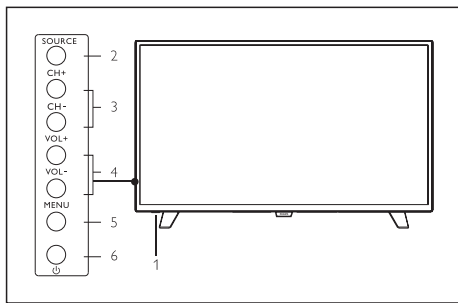

1. Indicator/Remote Control Sensor
2. Source : display the list of signal sources.
3. CH+/- : switch to the previous/next channel.
4. VoL +/- : increase/reduce the volume.
5. Menu : turn on/off the main menu.
6. : turn on/off the TV; to cut off power supply, please unplug the power cable.

Remote Control

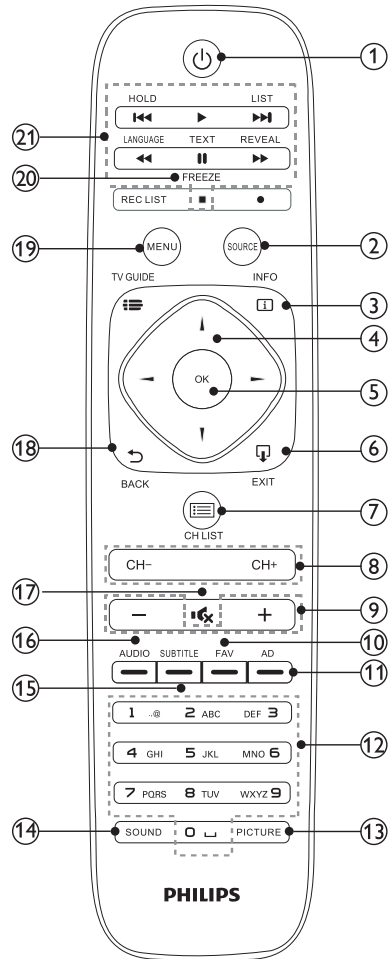

- ① Standby/Power on
 - Switches the TV to standby if it is on.
 - Powers on the TV if it is in standby.
- ② **Source**
Select a input source for the TV.
- ③ **INFO**
Display the program information when available.
- ④ **Navigation keys**
 - In menu mode: navigate the menu.

- ⑤ **OK**
- In menu mode: confirm the input or selection
- ⑥ **EXIT**
- Press this button to exit menu.
- ⑦ **CH LIST**
- Look through channel list
- ⑧ **CH +/-**
- Switch to the previous/next channel in TV mode.
- ⑨ **+/-**
- Increase/reduce the volume.
- ⑩ **FAV**
- Favorite channels.
- ⑪ **AD**
- Audio Description shortcut.
- ⑫ **Numeric keys (0~9)**
- Select a channel or value.
- ⑬ **PICTURE**
- Switch to the present image mode.
- ⑭ **SOUND**
- Switch to the present audio mode.
- ⑮ **SUBTITLE**
- Teletext green key or display subtitle message, when current channel has subtitle option.
- ⑯ **AUDIO**
- Audio Languages shortcut.
- ⑰ **MUTE**
- Mute or unmute the sound.
- ⑱ **BACK**
- Return to the previous operation.
- ⑲ **Menu**
- Turn on /off the menu.
- ⑳ **FREEZE**
- To freeze a scene in the TV program. Press again to return to the current scene.

- ㉑ **Shortcut keys in USB mode:**
 previous, Rewind, start, pause, Stop, Fast Forward, next.

Remote control usage

When you use the remote control, hold it close to the TV and point it at the remote control sensor. Make sure that the line-of-sight between the remote control and TV is not blocked by furniture, walls or other objects.

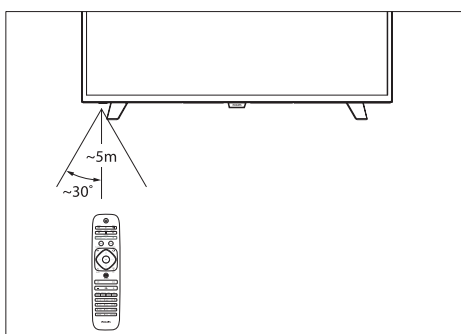

4 Use your TV

This section helps you perform basic TV operations.

Switch TV on or off

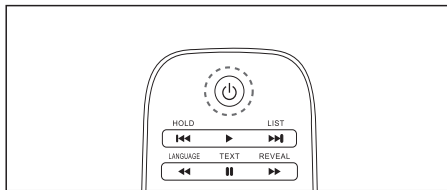
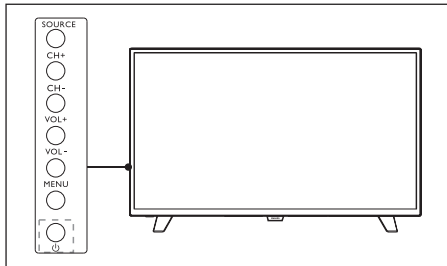

To switch on

- Plug in the power plug.
 - » If the standby indicator is lights up, press  (Standby-On) on the remote control.

To switch to standby

- Press  (Standby-On) on the remote control.
 - » The standby indicator switches to lights up.

Tip

- Though your TV consumes very little power when in standby mode, energy continues to be consumed. When not in use for an extended period of time, disconnect the TV power cable from the power outlet.

Switch channels

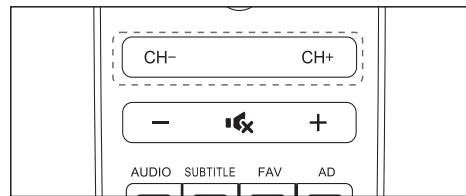
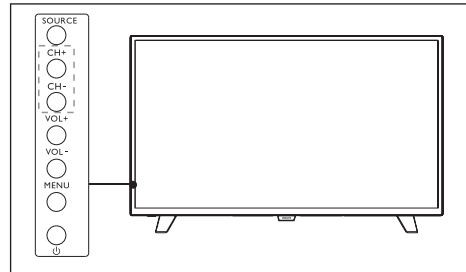

- Press **CH+/-** on the remote control or on the TV.
- Enter a channel number using the numeric buttons on the remote control.
- Press  on the remote control to switch and return to the previous channel.

Watch connected devices

Note

- Switch on the device before selecting it as an external signal source.

Use the Source button



- 1 Press **SOURCE**.
 - » The source list appears.
- 2 Press **▲▼** to select a device.
- 3 Press **OK** to select.
 - » The TV switches to the selected device.

Adjust TV volume

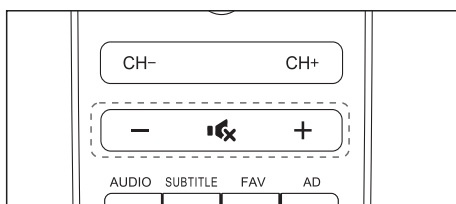
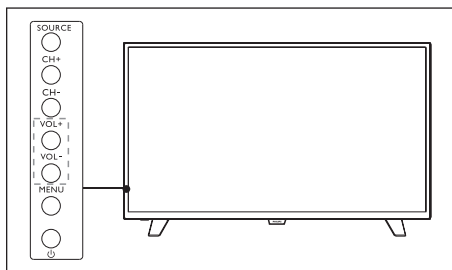

To increase or decrease volume

- Press **VOL+/-** on the TV or the **Volume Control +/-** on the remote control.

To mute or unmute sound

- Press **Mute**.
- Press **Mute** again to restore the sound.

PC Setting

When use your TV as the monitor, please make sure that VGA cable has been connected properly. (The PC refresh rate can't exceed of the TV).

- **Horizontal Position:** Move the screen toward left or right.
- **Vertical Position:** Move the screen toward up or down.
- **Size:** Set the size of the screen.
- **Phase:** Set a value of phase. Phase adjustment is to ensure that the ADC can make sample at the right time and get the best visual performance.
- **Auto Adjust:** Automatically adjust to obtain the best setting.

5 TV Operation

Channel Settings

Auto Tuning:

Press menu key, the channel icon will show on the screen.

Press **▲/▼** key to select channel, and press OK key to enter the channel menu. Press **▲/▼** key to select Auto Tuning. Press OK key the TV will be start auto tuning.

Tips: During auto tuning, press MENU key to exit it.

ATV Manual Tuning

Select ATV signal in source menu.

Press **▲/▼** key to select ATV Manual Tuning in channel menu. Press OK key to enter submenu. Press **▲/▼** key to select Storage to, TV system, Current Channel, Fine-Tune. Press **▲/▼** key to adjust these items, you can storage a channel by press the Red key on the remote control to save in current channel position. Select search and press OK key to search for the TV.

Channel Edit

Press **▲/▼** key to select Channel Edit, press OK key enter to channel list.

Delete: Press Red key on the remote control to delete the selected channel.

Move: Press Green key on the remote control to focus on a channel, press **▲/▼** key to select the channel position, press Green key to confirm.

Favourite: After choosing a channel, press Yellow key on the remote control to your favourite

channel, press Yellow key again to cancel it.

Skip: After selecting channel, press Blue key on the remote control to skip the channel, press Blue key again to cancel it.

Tips: Press MENU key to return channel menu.

Software Update (OAD)



Press **▲/▼** key to select Software Update (OAD) in channel menu. Press **▲/▼** key to select turn on or off.

OAD Tuning

Turn on Software Update (OAD),press OK key to Tuning,and press  key to exit tuning. Software Update (USB)

Press  key to select Software Update (USB) in channel menu.Update software of TV by U disk.

LOCK

Press MENU key ,the LOCK icon will show on the screen.Press  key to select Lock,then press OK key to enter lock menu.Input a password in the lock system,then press OK key to enter,press  key to select on or off. Set password: set a new password for your TV. Block Program: press the Green key on the remote control to lock your program in the program list.



Parental Guidance: adjust the program blocking level,this function help parents to block unsuitable channel for their child age.







Note: *Please input "3448" in lock sytem , if you have forgotten your password by waching TV.*

Time Setting



Press MENU key ,the Time icon will show on the screen,press  key to select Time and press OK key menu submenu.













(The time is means that the current code stream time of system.)

Off time: press  key to select off time, press OK key to enter and press  key to select : off time mode, hour minute.



- ① Off time mode: press  key to select off time mode,press  key to select off time of TV,such as: Off, Once , Everyday, Mon~Fri...etc.
- ② Hour: press  key to select hour, press  key adjust hours for off time of TV.
- ③ Minute: press  key to select minute, Press  key to adjust minutes for off time of TV.

★: Set the off time that the TV will switch off automatically at the time by you selected.(It is available in TV Mode.)



On time: press  key to select on time, press OK key to enter and press  key to select:On time mode,Input Source,Channel, Volume.



- ① On time mode: press  key to select On time mode,press  key to select the on time of TV ,such as :Off,Once, Everyday,Mon~Fri...etc.
 - ② Hour: press  key to select hour , press  key to adjust hours for the on time of TV.
 - ③ Minute: press  key to select minute, press  key to adjust minutes for on the of TV.
 - ④ Input Source: press  key to select input source,press  key to set input source signal for the on time of TV.
 - ⑤ Channel:press  key to select channel, press  key to set your channel for the on time of TV.
 - ⑥ Volume: press  key to select volume , press  key to set volume for the on time of TV.
- ★:Set the on time that the TV will be switched on automatically and tune to the mode of your TV at the time by you selected. (It is available in TV Mode.)



Sleep Timer:press  key to select sleep timer,press OK key to enter and press  key to set the sleep time of TV.



Time Zone:press  key to select time zone, press OK key to enter and  key to set the time zone of TV.



Settings

Press MENU key,the settings icon will show on the screen,press  key to select settings and press OK key to enter submenu. OSD Language: press  key to select OSD Language, and press  key to select the language for TV.

Subtitle: press  key to select Subtitle,and press  key to turn on or off.

Subtitle Language:turn on the subtitle,and select press  key to select subtitle language. Press OK key to enter,then press  key to select subtitle language.

Hearing Impaired:press  key to select hearing impaired,and press  key to turn on or off.

Restore user Default: press  key to select Restore user Default,press OK key to resume the factory setting. press  key to select YES or NO, press OK key to confirm this operation.

Soft Blue: press ▲/▼ key to select soft blue. press ◀/▶ key to adjust image display status.
 Shop Mode: Ipress ▲/▼ key to select shop mode,press ◀/▶ key to turn on or off
 Tips: press MENU key to Return main menu.

USB Media Function

Please insert a USB device into the USB interface of the TV,press SOURCE key to display the source menu.Press ◀/▶ key to select USB,and press OK key to enter USB menu.

Note: USB device file format are NTFS,FAT or FAT32.When connecting the USB port on an external device current is exceeded 500mA,it will be caused damage of the TV.If the USB device is working,do not pull out immediately,it will be caused damage of the TV system or the USB device system.

Media player UI icon introduction

Picture player menu options

- ⏮ : play the previous picture.
- ⏪ : play the next picture.
- ⏸ : pause/play lantern slide.
- ⏹ : quit the picture window
- ⏮ : set repeat mode:repeat none, repeat singel,repeat all.
- 📁 : show the picture playlist.
- Ⓜ : view the picture information.
- ⊞ : set random on or off.
- 🎵 : play the background music.
- ↻ : rotate 90° right .
- ↶ : rotate 90° left.
- 🔍 : zoom in the picture.
- 🔍 : zoom out the picture.
- 📏 : move the picture.

Music player menu options

- ⏮ : play the previous music.
- ⏪ : play the next music.
- ⏸ : pause/play the music.
- ⏹ : quit the music window.
- ⏮ : fast backward of the music,and press ▶ play key to play normally.
- ⏭ : fast forward of the music,press ▶ play key to play normally.

- ⏮ : set repeat mode:repeat none,repeat singel,repeat all.
- 📁 : show the music playlist.
- Ⓜ : view the music information.
- ⊞ : set A-B repeat playing,set point A and point B,the music will repeat between A and B.
- ⊞ : set random on or off.
- 🔊 : turn on or off the sound of music.
- ⏮ : select the playing time point of the music.

Video player menu options

- ⏮ : play the previous video.
- ⏪ : play the next video.
- ⏸ : pause/play the video.
- ⏹ : quit the video window.
- ⏮ : fast backward of the video,and press ▶ play key to play normally.
- ⏭ : fast forward of the video,and press ▶ play key to play normally.
- ⏮ : set repeat mode:repeat none, repeat singel,repeat all.
- 📁 : show the video playlist.
- Ⓜ : view the video information.
- ⊞ : set random on or off.
- ⊞ : set A-B repeat playing,set point A and point B,the video will repeat between A and B.
- ⏮ : slow motion of the video,slow down play speed,and you can press ▶ play key to play normally.
- ⏭ : step forward of the video,play on step by step,and you can press ▶ play key to play normally.
- ⏮ : select the playing time point of the video.
- 🔍 : zoom in the image.
- 🔍 : zoom out the image.
- ⊞ : slect aspect ratio of the video ,such as: Auto,4:3,Full.
- 📏 : move the picture.

Tips :The text operation is same as the picture,please refer to picture options.Also you can press ▶,◀,▶▶,⏮,⏭ on the remote control to the media player,press INFO key to show the tool bar on the screen.

6 Product information

Product information is subjected to change without notice. For detailed product information, please visit www.philips.com/support.

Display resolutions

Computer Formats

- Resolution - refresh rate:
 - 720×400 70Hz
 - 640×480 60Hz
 - 800×600 60Hz
 - 1024×768 60Hz
 - 1360×768 60Hz

HDMI Video Formats

- Resolution - refresh rate:
 - 480i - 60Hz
 - 480p - 60Hz
 - 576i - 50Hz
 - 576p - 50Hz
 - 720p - 50Hz, 60Hz
 - 1080i - 50Hz, 60Hz
 - 1080p - 50Hz, 60Hz.

Multimedia

- Supported storage device: USB (NTFS, FAT or FAT 32 USB storage devices are supported.)
- Compatible multimedia file formats:
 - Image: JPEG
 - Audio: MP3
 - Video: MPEG 2/MPEG 4 , H.264

Sound power

- 39" : 6W x 2

Inherent resolution

- 39" : 1366 x 768

Tuner / Reception / Transmission

- Aerial input: 75ohm coaxial (IEC75)
- Supported Systems:
ATV: PAL ,SECAM,I,D/K, B/G,L

Remote Control

- Batteries: 2 x AAA

Power Supply

- Main Power Supply:
100-240V~, 50/60Hz
- Standby Energy Consumption :
≤0.5W
- Environment Temperature: 5- 40°C
- Power consumption:
 - 39" : 55W

Supported TV mounts

To mount the TV, please purchase a Philips TV mount or any TV mount compliant with the VESA standard. To prevent damage to cables and connectors, be sure to leave a clearance gap of at least 2.2 inches or 5.5cm between the back of the TV to the wall.

Warning

- Please follow all instructions provided with the TV mount. TP Vision Europe B.V. bears no responsibility for improper actions. TV mounting that results in accident, injury or damage.

Model No.	Required Pixel Pitch (mm)	Required Mounting Screws
39"	200 x 300	4 x M6

7 Troubleshooting

This section covers common problems and their accompanying solutions.

General issues

The TV cannot be switched on:

- Disconnect the power cable from the power outlet. Wait for one minute before reconnecting it.
- Check that the power cable is securely connected.

The remote control is not working properly:

- Check that the remote control batteries are correctly inserted according to the +/- orientation.
- Replace the remote control batteries if they are flat or weak.
- Clean the remote control and TV sensor lens.

The TV menu is in the wrong language.

- Change the TV menu to your preferred language.

When turning the TV On/Off or to Standby, you hear a creaking sound from the TV chassis:

- No action is required. The creaking sound comes from the normal expansion and contraction of the TV as it cools down and warms up. This does not impact its performance.

Channel issues

Previously installed channels do not appear in the channel list:

- Check that the correct channel list is selected.

Picture issues

The TV is on, but there is no picture:

- Check that the antenna is properly connected to the TV.
- Check that the correct device is selected as the TV source.

There is sound but no picture:

- Check that the picture settings are correctly set.

Poor TV reception from the antenna connection:

- Check that the antenna is properly connected to the TV.
- Loudspeakers, unearthed audio devices, neon lights, high buildings and other large objects can influence reception quality. If possible, try to improve the reception quality by changing the antenna direction or moving devices away from the TV.
- If the reception on one particular channel is poor, please fine tune this channel.

There is poor picture quality from connected devices:

- Check that the devices are connected properly.
- Check that the picture settings are correctly set.

The picture does not fit the screen; it is too big or too small:

- Try using a different picture format.

The picture position is incorrect:

- Picture signals from some devices may not fit the screen correctly. Please check the signal output of the device.

Sound issues

The pictures are showing but sound quality is poor:

- Check that all cables are properly connected.
- Check that the volume is not set to 0.
- Check that the sound is not muted.
- Check that the sound settings are correctly set.

The pictures are showing but sound comes from one speaker only:

- Verify that sound balance is set to the centre.

HDMI connection issues

There are problems with HDMI devices:

- Please note that HDCP (High-bandwidth Digital Content Protection) support can delay the time taken for a TV to display content from a HDMI device.
- If the TV does not recognize the HDMI device and no picture is displayed, please try switching the signal source to another device before switching it back again.
- If there are intermittent sound disruptions, please check that output settings from the HDMI device are correct.

Computer connection issues

The computer display on the TV is not stable:

- Check that your PC uses the supported resolution and refresh rate.
- Set the TV picture format to unscald.

Contact us

If you cannot resolve your problem, please refer to the FAQs for this model at www.philips.com/support.

If the problem remains unresolved, please contact your local Philips Customer Service Centre.



Warning

- Do not attempt to repair the TV yourself. This may cause severe injury, irreparable damage to your TV or void your warranty.



Note

- Please make a note of your TV model and serial number before you contact Philips Customer Service Centre. These numbers are printed on the back/bottom of the TV and on the packaging.



All registered and unregistered trademarks are property of their respective owners. Specifications are subject to change without notice. Philips and the Philips' shield emblem are trademarks of Koninklijke Philips N.V. and are used under license from Koninklijke Philips N.V.

2017 © TP Vision Europe B.V. All rights reserved.
philips.com

