

xxHFL2819

User manual

Manuale utente

Manual do utilizador

Bedienungsanleitung

Mode d'emploi

Gebruikershandleiding

Руководство пользователя

Instrukcja obsługi

PHILIPS

Contents

Important	1
Use your TV	2
Remote control	2
Teletext	2
Digital teletext (for UK only)	2
Notifications, features and accessories	3
Energy efficiency	3
TV scroll button	3
Connecting power	3
Switching on/off	3
To switch the TV on	3
To switch the TV off	3
First time installation	3
Aerial installation	3
Cable installation	3
Media browser menu	4
Play media files from a USB drive	4
Change TV settings	4
Display options	4
Sound options	4
Configuring parental settings	4
Electronic program guide (EPG)	4
Program options	5
Update your TV	5
Automatic update from digital broadcast	5
Troubleshooting	5
TV will not turn on	5
Poor picture	5
No picture	5
No sound	5
Remote control - does not operate	5
Input sources - can not be selected	5
Specifications	6
PC input typical display modes	6
AV and HDMI signal compatibility	6

Important

'Read and understand all information in the accompanying Safety booklet before you install and use your TV. If damage is caused by failure to follow these instructions, the warranty does not apply.'

Disposal of old Equipment and Batteries

Please do not disposed this TV or battery as general household waste. If you want to dispose this product or battery, please consider the collection systems or facilities for appropriate recycling.

Notice: The sign Pb below the symbol for batteries indicates that this battery contains lead.

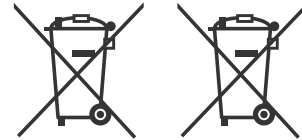

Products **Battery**

Use your TV

Remote control

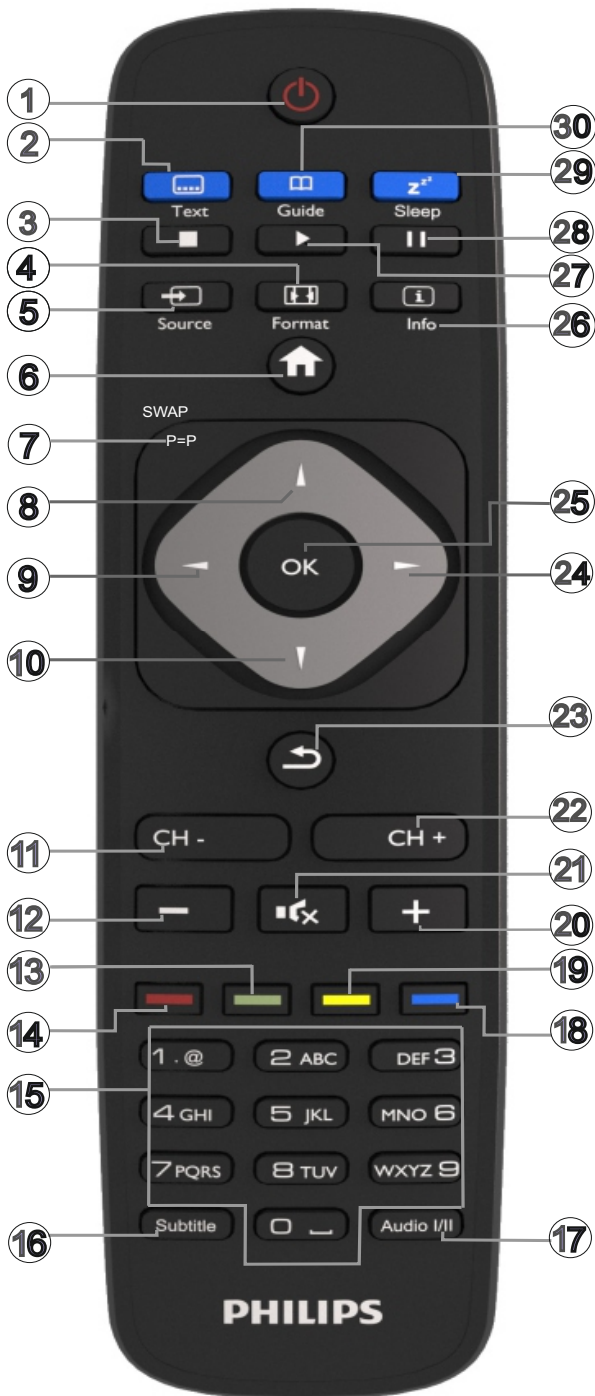

1. Standby
2. Teletext / Mix (in TXT mode)
3. Stop (in Media Browser mode)
4. Image Size
5. AV/ Source selection
6. Menu on-off/ Exit (in Media Browser mode)
7. Channel swap
8. Cursor up
9. Cursor left
10. Cursor down
11. Program Down / Page up (in TXT mode)
12. Volume Down
13. Green Button
14. Red Button
15. Numeric Buttons
16. Subtitle on-off / Subtitle (in Media Browser mode)
17. Mono-Stereo Dual I-II/ Audio Subtitle Language
18. Blue Button
19. Yellow Button
20. Volume Up
21. Mute
22. Program Up / Page down (in TXT mode)
23. Back / Return / Index page (in TXT mode)
24. Cursor Right
25. Okay (Confirm) / Hold (in TXT mode) / Channel List
26. Info / Reveal (in TXT mode)
27. Play / (in Media Browser Mode)
28. Pause (in Media Browser mode)
29. Set Sleep Timer
30. Electronic program guide (in DVB Channels)

NOTE: The Remote Control range is approximately 7m / 23ft.

Teletext

Press the **TEXT** button to enter. Press again to activate mix mode. Press once more to exit. Follow the instructions displayed on the teletext screen.

Digital teletext (for UK only)

Press the **TEXT** button to view digital teletext information. Operate it with the colored buttons, cursor buttons and the **OK** button. The operation method may differ depending on the contents of the digital teletext. Follow the instructions displayed on the digital teletext screen.

Notifications, features and accessories

Energy efficiency

This TV is designed with energy efficiency features:

- **Power save mode (ECO):** You can apply a combination of energy saving picture settings. While you watch TV, press the Menu button and, the Power Save Mode settings can be found in the 'Picture' section of the Main Menu.
- **Picture off mode:** If you only want to listen to audio from the TV, you can switch off the display. Other functions continue to operate normally. While you watch TV, press Menu and select Picture, and from there select 'Picture off' under the Power Save Mode option.

Note: Disconnect your TV from the mains plug in case your TV is going to be inactive for a long time.

TV scroll button

The TV Scroll button on the side of the TV allows you to control the volume, change channels and put the TV into standby.

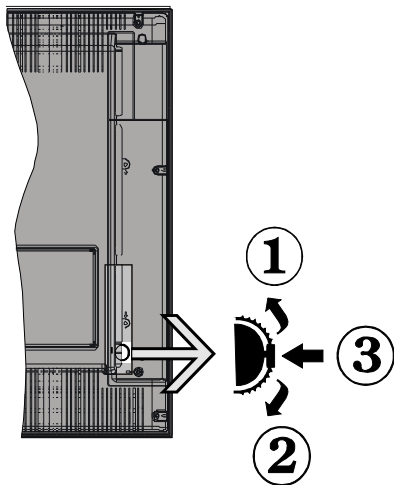

To change volume: Increase the volume by scrolling up. Decrease the volume by scrolling down.

To change channel:

1. Press the middle of the scroll button, the channel information banner will appear on the screen.
2. Scroll through the stored channels by pushing the button up or down.

To change source:

1. Press the middle of the button twice, the source list will appear on the screen.
2. Scroll through the available sources by pushing the button up or down.

To switch the TV to standby: Press the middle of the button down and hold it down for a few seconds, the TV will turn into standby mode.

Connecting power

The TV set is designed to operate on **220-240V AC, 50 Hz** socket. After unpacking, allow the TV set to reach the ambient room temperature before you connect the set to the mains. Plug the power cable to the mains socket outlet.

Switching on/off

To switch the TV on

To switch on the TV from standby mode either:

- Press the “” button, **CH-** or **CH+** or a numeric button on the remote control.
- Press the side function switch until the TV comes on from standby.

Note: If the TV has been left on and not been operated for a while, the TV will go into standby. When you next switch-on, the following message will be displayed: “**Standby Cause No Operation**”. Press **OK** to continue.

To switch the TV off

- Press the “” button on the remote control or press the side function switch until the TV switches into standby mode.

Note: To power down the TV completely, unplug the power cord from the mains socket.

First time installation

You will see the language selection screen when you first turn on your TV. Select your preferred language and press OK followed by the selection Home Mode/ Shop Mode.

You can set up your TV by following the First Time Installation (FTI) screen with the following selections.

Aerial installation

Select the **AERIAL** option from the **Search Type** screen to search for terrestrial digital TV broadcasts.

Optional a channel list, which is generated by LCN (*), will be displayed on screen when the search is over. Select “Yes” and press OK to store this list.

Press “” button to quit channel list and watch TV.

(*) LCN is the Logical Channel Number system that organizes available broadcasts in accordance with a recognizable channel sequence (if available).





Cable installation

Select **CABLE** option and press **OK** on the remote control. For automatic installation in case your Cable network supplier supports a Network-ID based installation (e.g. Unitymedia), select **YES** in following screen and press OK.

In case your Cable network supplier does not support a Network-ID based installation please select “**NO**”, press **OK** and follow the instruction on the screen. You can also select frequency ranges from this screen.

Media browser menu



Loop/Shuffle Mode Operation

Start playback with ► and activate 	TV plays next file and loop the list.
Start playback with OK and activate 	File will be played in a loop (repeat).
Start playback with OK/► and activate 	File will be played in a shuffle.
Start playback with OK/► and activate 	File playback will continue randomly and random playback will continue.

Enter the frequency range manually by using the numeric button.

Note: Searching duration will change depending on the selected search step.

Play media files from a USB drive

You can play photo, music, and movie files stored on a USB disk by connecting it to your TV. Connect a USB disk to one of the USB inputs located on the side of the TV. Pressing the “” button while in the Media Browser mode will access the Picture, Sound and Settings menu options. Pressing the “” button again will exit from this screen. You can set your Media Browser preferences by using the Settings Menu.

IMPORTANT! Back up your files before making any connections to the TV. The manufacturer will not be responsible for any file damage or data loss. Certain types of USB devices, for example, MP3 players or USB hard disk drives/memory sticks may not be compatible with this TV.

Change TV settings

To access the options listed below;

- 1- Press the Menu button
- 2- Highlight your selection
- 3- Press OK to confirm

Display options

Mode: Changes the picture mode to one of the following: Cinema, Game, Sports, Dynamic and Natural.

Contrast: Sets the light and dark values of the image.

Brightness: Sets the brightness value of the image.

Sharpness: Sets the sharpness value. A high sharpness value may result in a clearer, crisper image depending on the content.

Color: Sets the color value.

Backlight: Controls the brightness of the backlight.

Noise reduction: Reduces the noise level in the image.

Sound options

Volume: Adjusts volume level.

Equalizer: Changes the equalizer mode.

Balance: Adjusts whether the sound is coming mainly from the right or left speakers.

Headphone: Sets headphone volume.

Sound mode: Sets the preferred sound mode.

AVL: Sets a limit to maximum volume output.

Digital Out: Sets digital out audio type.

Configuring parental settings

This feature is for restricting access to selected content. It is controlled by a pin number defined by you. Factory default is “0000”.

Menu lock (optional): Menu lock setting enables or disables the menu access.

Maturity lock (optional): When set, this option gets the maturity information from the broadcast and if this maturity level is disabled, disables access to the broadcast.

Child lock (optional): When Child Lock is set, the TV can only be controlled by the remote control. In this case the control panel buttons will not work.

Set PIN: Defines a new PIN number.

Note: If the Country option is set to France, you can use 4725 as the default code.

Electronic program guide (EPG)

Some, but not all channels send information about the current and next programs. Press the “GUIDE” button to view the EPG menu.

Up/Down/Left/Right: Navigate EPG.

OK: Displays program options.

INFO: Displays, in detailed, information on the program selected.

GREEN: Switches to List Schedule EPG.

YELLOW: Switches to Timeline Schedule EPG.

BLUE: Displays filtering options.

Program options

In **EPG** menu, press the **OK** button to enter the **Event Options** menu.

Select Channel

In **EPG** menu, using this option, you can switch to the selected channel.

Set Timer / Delete timer

After you have selected a program in the **EPG** menu, press **OK**. Select the **Set Timer on Event** option and press **OK**. You can set a timer for future programs.

Update your TV

Navigate on your main menu, choose settings, the version of the current software is displayed.

Caution: Do not install a lower version of software than the current version installed on your product. TP Vision cannot be held liable or be made responsible for problems caused by a software downgrade.

Update with USB

Before you update the software, make sure that you have:

- A USB storage device that has at least 256 megabytes of storage space, is FAT or DOS formatted and has its write protection disabled.
- Access to a computer with a USB connector and Internet access

Navigate to www.philips.com/support, and follow the software update instructions.

Automatic update from digital broadcast

While the TV is connected to an aerial signal. If Automatic scanning in the Upgrade Options menu is enabled, the TV wakes up at 03:00 and searches broadcast channels for new software upgrades. If new software is found and downloaded successfully, the next time the TV powers up, it will have the new software version.

Note: If the TV fails to come on after the upgrade unplug the TV for 2 minutes and plug in again.

Troubleshooting

TV will not turn on

Make sure the power cord is plugged in securely to wall outlet. The batteries in the remote control may be exhausted. Press the Power button on the TV.

Poor picture

- Have you selected the correct TV system?
- Low signal level can cause picture distortion. Please check antenna access.

- Check if you have entered the correct channel frequency if you have done manual tuning.
- The picture quality may degrade when two devices are connected to the TV at the same time. In such a case, disconnect one of the devices.

No picture

- No Picture means that your TV is not receiving a transmission. Have you selected the correct button on the remote control? Try once more. Also make sure the correct input source has been selected.
- Is the antenna connected properly?
- Is the antenna cable damaged?
- Are suitable plugs used to connect the antenna?
- If you are in doubt, consult your dealer.

No sound

- Has the TV been set to mute? To cancel mute, press the  button, or increase the volume level.
- Sound is coming from only one speaker. Is the balance set to one extreme? See Sound Menu section.

Remote control - does not operate

- The batteries may be exhausted. Replace the batteries.

Input sources - can not be selected

- If you cannot select an input source, it is possible that no device is connected. if not
- Check the AV cables and connections if you have tried to connect a device.

Specifications

PC input typical display modes

The following table is an illustration of some of the typical video display modes.

Index	Resolution	Frequency
1	800x600	56 Hz
2	800x600	60 Hz
3	1024x768	60 Hz
4	1024x768	66 Hz
5	1280x768	60 Hz
6	1360x768	60 Hz
7	1280x960	60 Hz
8	1280x1024	60 Hz
9	1400x1050	60 Hz
10	1600x1200	60 Hz
11	1920x1080	60 Hz

AV and HDMI signal compatibility

Source	Supported Signals	Available	
EXT (SCART)	PAL 50/60	○	
	NTSC 60	○	
	RGB 50	○	
	RGB 60	○	
Side AV	PAL 50/60	○	
	NTSC 60	○	
PC/ YPbPr	480I, 480P	60Hz	○
	576I, 576P	50Hz	○
	720P	50Hz,60Hz	○
	1080I	50Hz,60Hz	○
	1080P	50Hz,60Hz	○
HDMI1	480I	60Hz	○
	480P	60Hz	○
	576I, 576P	50Hz	○
	720P	50Hz,60Hz	○
	1080I	50Hz,60Hz	○
	1080P	24Hz, 25Hz 30Hz, 50Hz, 60Hz	○

Supported file formats in USB mode

Media	File Extension	Format		Remarks (Maximum resolution/Bit rate etc.)
		Video	Audio	
Movie	mpg, mpeg	MPEG1, MPEG2		MPEG1: 768x576 @30P MPEG2:1920x1080 @ 30P
	vob	MPEG2		1920x1080 @ 30P
	mp4	MPEG4, Xvid , H.264		
	mkv	H.264, MPEG4,VC-1		
	avi	MPEG2, MPEG4, Xvid , H.264		
	flv	H.264/VP6/Sorenson		H.264/VP6:1920x1080 @ 30P Sorenson: 352x288 @30P
	3gp	MPEG4 , H.264		1920x1080 @ 30P
Music	.mp3	-	MPEG 1 Layer 2	32Kbps ~ 448Kbps(Bit rate) 32K, 44.1k, 48k Hz,16K, 22.05K, 24K Hz (Sampling rate)
			MPEG 1 Layer 3	32Kbps ~ 320Kbps(Bit rate) 32K, 44.1k, 48k Hz,16K, 22.05K, 24K Hz,8K, 11.025K, 12K Hz (Sampling rate)
Photo	.jpg .jpeg	Baseline JPEG	-	max WxH = 17000x10000 4147200bytes
	.	Progressive JPEG	-	max WxH = 4000x4000 3840000bytes
	.bmp	-	-	max WxH = 5760x4096 3840000bytes
Subtitle	.sub .srt	-	-	-

HOTEL MODE

The hotel mode is a special mode which restricts some operations of TV. This allows the customer to use the TV in special places such as hotels, prisons or hospitals. These restrictions are basically given below.

- The user cannot increase the volume above a specified limit. And can set fixed volume value.
- The user can enable headphone direct volume control.
- The user cannot reach some menus.
- The user cannot use the buttons on the TV.
- The user can limit the star-up source position.
- Last status can/cannot be used.
- Teletext can be disabled or enabled.
- NVRAM data (like service list and user preferences, etc.) can be copied to or from a USB device.
- Pin8 can/cannot be used.

To enter hotel menu, press the  (**MENU/M**) button on the remote. Main TV menu will appear. Press the 3-1-9-7-5-3-mute buttons consecutively.

HOTEL MENU ITEMS

Hotel Mode

Set as 'On' to activate hotel mode. In hotel mode, channel list and install menu are blocked.

Last Status

Set as 'On' to enable the TV to reopen with the closing status.

Panel Lock

Set as 'On' to prohibit the use of the buttons on the TV.

RCU Inhibit

Set as 'On' to inhibit the use of the remote. To turn this option off, repeat the steps to open hotel menu. Remote control will function in Stand-By mode independently from the setting of this option.

Startup Position

You can specify the opening settings of the TV. Choose the channel and/or source to be opened when the TV is switched on next time. The available options are as the following:

Auto: The TV will open with the last channel(if TV was the last source) or last source.

TV: The TV will open with the channel that is specified in "**Startup Channel**" menu item.

Other external sources (EXT1, HDMI2, PC, FAV, SVHS etc.): The TV will open with the specified source.

Startup Channel

You can specify a channel to be displayed when the TV is turned on next time, if '**Startup Position**' is set as '**TV**'.

Volume Limit

Set the maximum value of the volume.

Fixed Volume Enable

Set as 'On' to enable the use of fixed volume value which is set in "**Fixed Volume Value**" menu item.

Fixed Volume Value

Set the value of the volume to be fixed.

Headphone Direct Volume

Set as '**Enabled**' to control the headphone volume through remote control. When this feature is enabled, volume control buttons will not change the TV's main sound. You can change the sound of the TV from the '**Sound**' menu.

OSD Disable

The default value is set as '**Disable Setup Menus**' for hotel mode. You can block all menus by setting this item as '**Disable All Menus**'.

Invisible Setup Menus are:

Main menu: Installation, Channel list

Settings menu: Language, Parental, Sources, Other settings

Teletext

You can enable or prohibit the teletext services(or MHEG if available) by setting this item as '**On**' or '**Off**'.

WakeUp Time Channel

Set the channel, whose time information is to be used for wakeup timer. If this option is set as "0", time information of the channel which is being watched will be used.

Note: If hotel mode is active, '**Add wake up timer**' function will be available in '**Settings/Timers**' menu. After the new timer is saved, the TV will wake up automatically on desired time.

Wakeup Time Volume

Set the wakeup volume value of the TV. This value can't be set as greater than the value in '**Volume Limit**' menu item.

Copy To USB (USB cloning)

You can copy the NVRAM data (service list, preferences, etc.) to a USB device using this option. Press **OK** to copy those files from TV to USB.

Copy From USB (USB cloning)

You can copy the NVRAM data (service list, preferences, etc.) from a USB device using this option. Press **OK** to copy those files from USB to TV.

Note: USB device, which will be used for USB cloning functions, must be FAT32 formatted.

USB Option

Set as '**Off**' to disable the USB ports on the TV.

Fixed Pic. Mode

Set as '**On**' to disable picture setting menus.

Digital Tuner

Set as '**Off**' to disable digital channels. When a digital channel is opened from the channel list, "no signal" message will be displayed and digital channels will not be listed when manual or auto searches are performed.

Multiple RC Support

You can choose one of the predefined remotes or set as '**Off**'. You can set the RCU type from 'RCU program menu'. The shortcut of this menu is RETURN-1-2-3-4.

Welcome Screen

You can set a welcome screen image using this option. If this option is enabled a welcome screen message will be displayed after turning the TV on. The image will stay on the screen until you press any key on the remote.

NIT Update

If this option is enabled LCN informations will be updated automatically. This option is available only for Nordic countries.

High Security

If you set this option as **ON**, the Hotel TV menu will be accessible only via the Philips hospitality remote.

Reset to Default Values

Highlight this option and press the **OK** button on the remote to return the TV to default settings.

EPG Enabled/Disable

If you enable this option the EPG menu will be accessible while the TV is in Hotel mode.



Specifications are subject to change without notice.

Philips and the Philips' shield emblem are registered trademarks of Koninklijke Philips N.V. and are used under license from Koninklijke Philips N.V.

2015 © TP Vision Europe B.V. All rights reserved.

www.philips.com

