

User Manual

24HFL3011T
32HFL3011T
40HFL3011T

PHILIPS

Contents

1	Setting up	3
1.1	Read safety	3
1.2	TV stand and wall mounting	3
1.3	Tips on placement	3
1.4	Power cable	3
1.5	Antenna cable	3
2	Connect devices	5
2.1	About connections	5
2.2	Common interface - CAM	7
2.3	Set-top box - STB	8
2.4	Home Theatre System - HTS	8
2.5	Blu-ray Disc player	10
2.6	DVD player	10
2.7	Game console	10
2.8	USB flash drive	11
2.9	Camcorder	11
2.10	Computer	11
2.11	Headphones	12
3	Switch on	13
3.1	On, Standby or Off	13
3.2	Keys on TV	13
3.3	Sleep timer	13
3.4	Switch Off Timer	13
4	Remote control	15
4.1	Key overview	15
4.2	IR sensor	16
4.3	Batteries	16
4.4	Cleaning	16
5	TV channels	17
5.1	Channel Lists	17
5.2	Watching TV channels	17
6	Channel installation - Antenna, Cable	21
6.1	Update channels	21
6.2	Reinstall channels	21
6.3	DVB-T or DVB-C	21
7	TV guide	23
7.1	What you need	23
7.2	Using the TV guide	23
8	Sources	24
8.1	Switch to a device	24
8.2	From standby	24
8.3	EasyLink	24
9	Timers and clock	25
9.1	Sleep timer	25
9.2	Clock	25
9.3	Switch off timer	25
10	Videos, Photos and Music	26
10.1	From a USB connection	26
10.2	Play your videos	26
10.3	View your photos	26
10.4	Play your music	27
11	Settings	28
11.1	Picture	28
11.2	Sound	31
11.3	General settings	34
12	Specifications	37
12.1	Environmental	37
12.2	Reception	38
12.3	Display	38
12.4	Power	38
12.5	Dimensions and weights	39
12.6	Connectivity	39
12.7	Sound	39
12.8	Multimedia	39
13	Software	40
13.1	Software version	40
13.2	Open source software	40
13.3	Open source license	40
14	Troubleshooting and support	42
14.1	Troubleshooting	42
14.2	Register	43
14.3	Online help	43
14.4	Consumer Care / Repair	43
15	Safety and care	45
15.1	Safety	45
15.2	Screen care	46
16	Terms of Use	47
16.1	Terms of Use - TV	47
16.2	Copyrights	47
	Index	49

Setting up

1.1

Read safety

Read the safety instructions first before you use the TV.

1.2

TV stand and wall mounting

TV stand

You can find the instructions for mounting the TV stand in the Quick Start Guide. The Quick Start Guide can be downloaded from www.philips.com.

Use the product type number of the TV to look for the Quick Start Guide to download.

Wall mounting

Your TV is also prepared for a VESA-compliant wall mount bracket (sold separately).

Use the following VESA code when purchasing the wall mount . . .

To fix the bracket securely, use screws with a length indicated in the drawing.

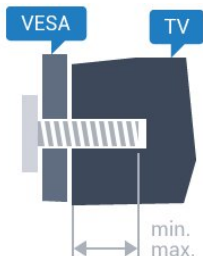

- 24HFL3011 - VESA MIS-F 75x75, M4 (Minimum 10 mm, Maximum 12 mm)
- 32HFL3011 - VESA MIS-F 100x100, M4 (Minimum 10 mm, Maximum 15 mm)
- 40HFL3011 - VESA MIS-F 200x200, M4 (Minimum 10 mm, Maximum 15 mm)

Caution

Wall mounting the TV requires special skills and should only be performed by qualified personnel. The TV wall mounting should meet safety standards according to the TV's weight. Also read the safety precautions before positioning the TV.

TP Vision Europe B.V. bears no responsibility for improper mounting or any mounting that results in accident or injury.

Tips on placement

- Position the TV where light does not shine directly on the screen.
- Position the TV up to 15 cm away from the wall.
- The ideal distance to watch TV is 3 times its diagonal screen size. When seated, your eyes should be level with the centre of the screen.

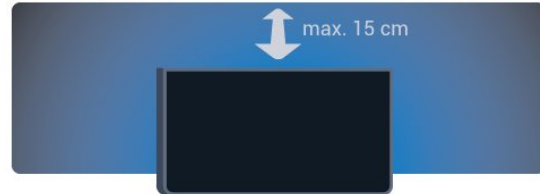

1.4

Power cable

- Insert the power cable into the **POWER** connector on the back of the TV.
- Make sure the power cable is securely inserted in the connector.
- Make sure that the power plug, in the wall socket, is accessible at all times.
- When you unplug the power cable, always pull the plug, never pull the cable.

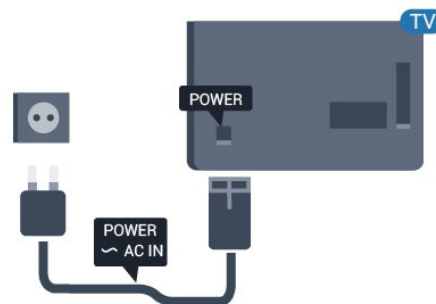

Although this TV has a very low standby power consumption, unplug the power cable to save energy if you do not use the TV for a long period of time.

Antenna cable

Insert the antenna plug firmly into the **ANTENNA** socket at the back of the TV.

You can connect your own antenna or an antenna signal from an antenna distribution system. Use an IEC Coax 75 Ohm RF antenna connector.

Use this antenna connection for DVB-T and DVB-C input signals.

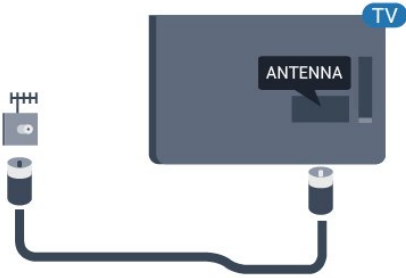

Connect devices

About connections

Connectivity guide

Always connect a device to the TV with the highest quality connection available. Also, use good quality cables to ensure a good transfer of picture and sound.

If you need help to connect several devices to the TV, you can visit the Philips TV connectivity guide. The guide offers information on how to connect and which cables to use.

Go to www.connectivityguide.philips.com

Antenna port

If you have a Set-top box (a digital receiver) or Recorder, connect the antenna cables to run the antenna signal through the Set-top box and/or Recorder first before it enters the TV. In this way, the antenna and the Set-top box can send possible additional channels to the Recorder to record.

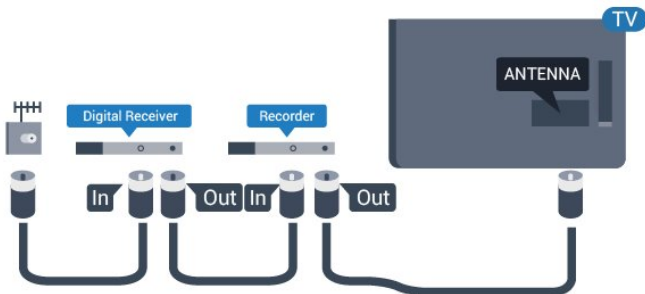

HDMI ports

HDMI quality

An HDMI connection has the best picture and sound quality. Use an HDMI cable for TV signal.

For best signal quality transfer, use a High speed HDMI cable and do not use an HDMI cable longer than 5 m.

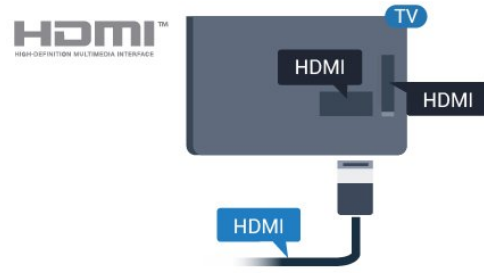

Copy protection

HDMI cables support HDCP (High-bandwidth Digital Content Protection). HDCP is a copy protection signal that prevents copying content from a DVD disc or Blu-ray Disc. Also referred to as DRM (Digital Rights Management).

HDMI ARC

HDMI 1 connection on the TV have HDMI ARC (Audio Return Channel). If the device, typically a Home Theatre System (HTS), also has the HDMI ARC connection, connect it to HDMI 1 on this TV. With the HDMI ARC connection, you do not need to connect the extra audio cable that sends the sound of the TV picture to the HTS. The HDMI ARC connection combines both signals.

In case you prefer to switch off ARC on the HDMI connections,

Consumer Mode: On – Press **HOME**.

Guest Mode: On – Guest Menu: Not available in Guest Menu.

(For professional mode information, please refer to Installation manual)

Select **Setup > TV settings > Sound > Advanced > HDMI 1 - ARC > Off** .

HDMI Ultra HD

You can watch videos filmed or made in 'native' Ultra HD resolution – 3840x2160 pixels – on this TV.

Connect a Blu-ray Disc player, game console or computer that plays Ultra HD videos to one of HDMI connections. Use a High speed HDMI cable to connect. The HDMI UHD connections have ARC (Audio Return Channel).

HDMI CEC - EasyLink

EasyLink

With EasyLink you can operate a connected device with the TV remote control. EasyLink uses HDMI CEC (Consumer Electronics Control) to communicate with the connected devices. Devices must support HDMI CEC and must be connected with an HDMI connection.

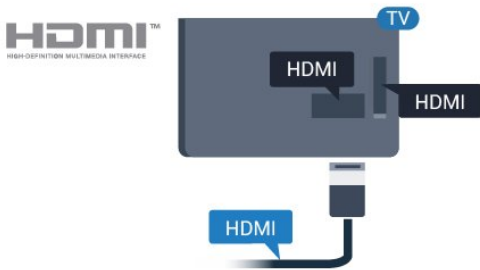

EasyLink setup

The TV comes with EasyLink switched on. Make sure that all HDMI CEC settings are properly set up on the connected EasyLink devices. EasyLink might not work with devices from other brands.

HDMI CEC on other brands

The HDMI CEC functionality has different names on different brands. Some examples are: Anynet, Aquos Link, Bravia Theatre Sync, Kuro Link, Simplink and Viera Link. Not all brands are fully compatible with EasyLink.

Example HDMI CEC branding names are property of their respective owners.

Operate devices

To operate a device connected to HDMI and set up with EasyLink, select the device - or its activity - in the list of TV connections.

Press **HOME**, select **SOURCES**, select a device connected to an HDMI connection and press **OK**.

Once the device is selected, the TV remote control can control the device.

However **HOME** and **OPTIONS** keys and some other TV keys are not forwarded to the device. If the key you need is not on the TV remote control, you can select the key in the Options menu.

Press **OPTIONS** and select **Controls** in the menu bar. On the screen, select the device key you need and press **OK**.

Some very specific device keys might not be available in the Controls menu.

Note: Only devices that support **EasyLink Remote**

Control function will respond to the TV remote control.

EasyLink On or Off

The TV comes with all EasyLink settings switched on. You can switch off any EasyLink setting independently.

To switch off EasyLink completely . . .

Consumer Mode: On – Not available in Consumer mode.

Guest Mode: On – Guest Menu: Not available in Guest Menu.

(For professional mode information, please refer to Installation manual)

EasyLink Remote Control

If you want devices to communicate but you don't want to operate them with the TV remote control, you can switch off EasyLink remote control separately. You can control multiple HDMI-CEC compliant devices with your TV remote control.

In the EasyLink settings menu, select **EasyLink Remote Control** and select **No**.

DVI to HDMI

If you still own a device that only has a DVI connection, you can connect the device to any of the **HDMI** connection with a DVI to HDMI adapter.

Use a DVI to HDMI adapter if your device only has a DVI connection. Use one of the HDMI connections and add an Audio L/R cable (mini-jack 3.5mm) to Audio In for sound, on the back of the TV.

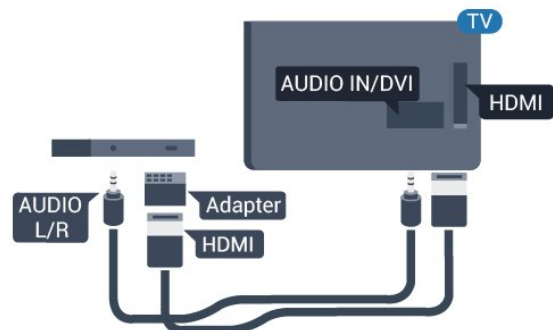

Copy protection

DVI and HDMI cables support HDCP (High-bandwidth Digital Content Protection). HDCP is a copy protection signal that prevents copying content from a DVD disc or Blu-ray Disc. Also referred to as DRM (Digital Rights Management).

Y Pb Pr – Audio L R

Y Pb Pr – Component Video is a high quality connection.

The YPbPr connection can be used for High Definition (HD) TV signals. Next to the Y, Pb and Pr signals add the Audio Left and Right signals for sound.

Match the YPbPr (green, blue, red) connector colours with the cable plugs when you connect. Use an Audio L/R cinch cable if your device also has sound.

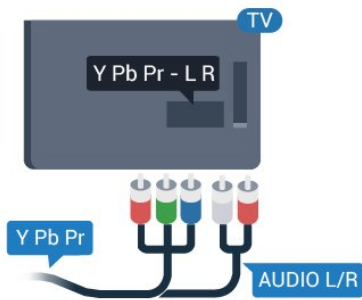

CVBS – Audio L R

CVBS – Composite Video is a high quality connection. Next to the CVBS signal adds the Audio Left and Right signals for sound.

Audio Out – Optical

Audio Out – Optical is a high quality sound connection. This optical connection can carry 5.1 audio channels. If your device, typically a Home Theatre System (HTS), has no HDMI ARC connection, you can use this connection with the Audio In – Optical connection on the HTS. The Audio Out – Optical connection sends the sound from the TV to the HTS.

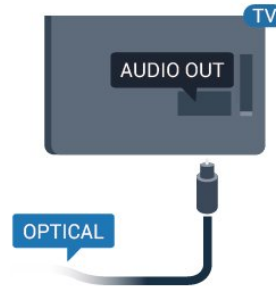

You can set the type of the audio out signal to fit the audio capabilities of your Home Theatre System.

If the sound does not match the video on screen, you can adjust the audio to video synchronization.

2.2

Common interface – CAM

CI+

This TV is ready for the CI+ Conditional Access.

With CI+ you can watch premium HD programmes, like movies and sports, offered by digital TV broadcasters in your region. These programmes are scrambled by the TV broadcaster and descrambled with a prepaid CI+ module.

Digital TV broadcasters provide this CI+ module (Conditional Access Module – CAM) when you subscribe to their premium programmes. These programmes have a high level of copy protection.

Contact a digital TV broadcaster for more information on terms and conditions.



CAM

Insert a CAM module

Switch off the TV before inserting a CAM. Look on the CAM for the correct method of insertion. Incorrect insertion can damage the CAM and TV.

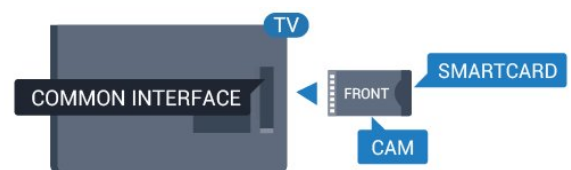

Use the Common Interface slot on the TV to insert the CAM card.

With the front of the card facing to you, gently insert the CAM as far as it will go.
Leave the card in the slot permanently.

It may take a few minutes before the CAM is activated. Removing the CAM will deactivate the broadcast service on TV.

If a CAM is inserted and subscription fees are paid, (connection methods can differ), you can watch the TV broadcast. The inserted CAM is exclusively for your TV.

2.3

Set-top box - STB

Use 2 antenna cables to connect the antenna to the Set-top box (a digital receiver) and the TV.

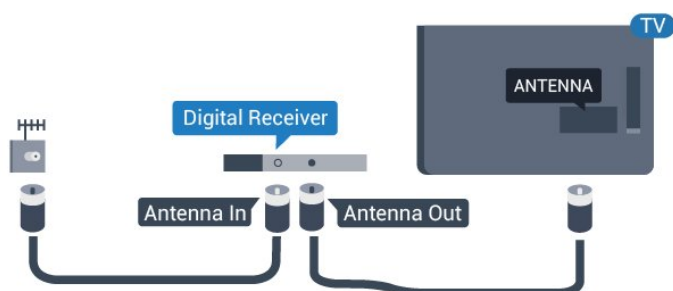

Next to the antenna connections, add an HDMI cable to connect the Set-top box to the TV.

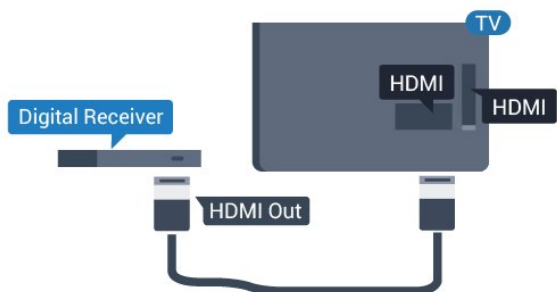

Auto switch off

Switch off this automatic timer, if you only use the remote control of the Set-top box. Do this to prevent the TV from switching off automatically after a 4 hour period without a key press on the remote control of the TV.

Consumer Mode: On – Press **HOME**.

Guest Mode: On – Guest Menu: Not available in Guest Menu.

(For professional mode information, please refer to Installation manual)

Select **Setup > TV settings > General settings > Switch off timer** and set the slider bar to **Off**.

2.4

Home Theatre System - HTS

Connect with HDMI ARC

Use an HDMI cable to connect a Home Theatre System (HTS) to the TV. You can connect a Philips Soundbar or an HTS with a built-in disc player.

HDMI ARC

HDMI 1 connection on the TV have HDMI ARC (Audio Return Channel). If the device, typically a Home Theatre System (HTS), also has the HDMI ARC connection, connect it to HDMI 1 on this TV. With the HDMI ARC connection, you do not need to connect the extra audio cable that sends the sound of the TV picture to the HTS. The HDMI ARC connection combines both signals.

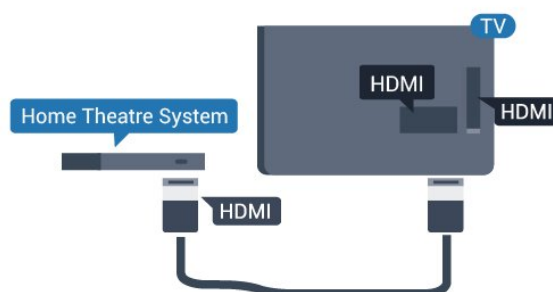

Audio to video synchronisation (sync)

If the sound does not match the video on screen, you can set a delay on most Home Theatre Systems with a disc player to match the sound with the video.

Connect with HDMI

Use an HDMI cable to connect a Home Theatre System (HTS) to the TV. You can connect a Philips Soundbar or an HTS with a built-in disc player.

If the Home Theatre System has no HDMI ARC connection, add an optical audio cable (Toslink) to send the sound of the TV picture to the Home Theatre System.

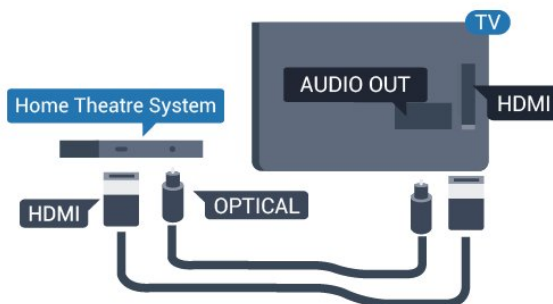

Audio to video synchronisation (sync)

If the sound does not match the video on screen, you can set a delay on most Home Theatre Systems with a disc player to match the sound with the video.

Audio Out settings

Audio Out delay

With a Home Theatre System (HTS) connected to the TV, the picture on TV and the sound from the HTS should be synchronised.

Automatic audio to video sync

With recent Philips Home Theatre Systems, the audio to video sync is automatically synchronised and always correct.

Audio sync delay

For some Home Theatre Systems you might need to adjust the audio sync delay to synchronise the audio to video. On the HTS, increase the delay value until there is a match between picture and sound. A delay value of 180ms may be required. Read the user manual of the HTS. With a delay value set up on the HTS, you need to switch off Audio Out delay on the TV.

To switch off the Audio Out delay . . .

1. Consumer Mode: On – Press **HOME**.
Guest Mode: On – Guest Menu: Not available in Guest Menu.
(For professional mode information, please refer to Installation manual)
2. Select **Setup > TV settings > Sound > Advanced > Audio out delay**.
3. Select **Off** and press **OK**.
4. Press **↩**, repeatedly if necessary, to close the menu.

Audio Out offset

If you cannot set a delay on the Home Theatre System, you can set the TV to sync the sound. You can set an offset that compensates the time necessary for the Home Theatre System to process the sound of the TV picture. You can set the value in steps of 1ms. Maximum setting is 12ms. The Audio out delay setting should be switched on.

To synchronise the sound on the TV . . .

1. Consumer Mode: On – Press **HOME**.
Guest Mode: On – Guest Menu: Not available in Guest Menu.
(For professional mode information, please refer to Installation manual)
2. Select **Setup > TV settings > Sound > Advanced > Audio out offset**.
3. Use the slider bar to set the sound offset and

press **OK**.

4. Press **↩**, repeatedly if necessary, to close the menu.

Audio Out format

If you have a Home Theatre System (HTS) with multichannel sound processing capabilities like Dolby Digital, DTS® or similar, set the Audio out format to Multichannel. With Multichannel, the TV can send the compressed multichannel sound signal from a TV channel or connected player to the Home Theatre System. If you have a Home Theatre System without multichannel sound processing, select Stereo.

To set the Audio Out format . . .

1. Consumer Mode: On – Press **HOME**.
Guest Mode: On – Guest Menu: Not available in Guest Menu.
(For professional mode information, please refer to Installation manual)
2. Select **Setup > TV settings > Sound > Advanced > Audio out format**.
3. Select **Multichannel** or **Stereo**.
4. Press **↩**, repeatedly if necessary, to close the menu.

Audio Out levelling

Use the Audio Out leveling setting to level the volume (loudness) of the TV and the Home Theatre System when you switch over from one to another. Volume differences can be caused by differences in sound processing.

To level the difference in volume . . .

1. Consumer Mode: On – Press **HOME**.
Guest Mode: On – Guest Menu: Not available in Guest Menu.
(For professional mode information, please refer to Installation manual)
2. Select **Setup > TV settings > Sound > Advanced > Audio out leveling**.
3. If the volume difference is large, select **More**. If the volume difference is small, select **Less**.
Press **↩**, repeatedly if necessary, to close the menu.

Audio Out leveling affects both the Audio Out - Optical and HDMI ARC sound signals.

Problems with HTS sound

Sound with loud noise

If you watch a video from a plugged in USB flash drive or connected computer, the sound from your Home Theatre System might be distorted.

1. Consumer Mode: On – Press **HOME**.
Guest Mode: On – Guest Menu: Not available in Guest Menu.
(For professional mode information, please refer to Installation manual)
2. Select **Setup > TV settings > Sound > Advanced > Audio out format**.

No sound

If you cannot hear the sound from the TV on your Home Theatre System, check the following . . .

– Check if you connected the HDMI cable to a **HDMI 1** connection on the Home Theatre System.

– Check if the **HDMI ARC** setting on the TV is switched **On**.

Go to...

- Consumer Mode: On – Press **HOME**.
Guest Mode: On – Guest Menu: Not available in Guest Menu.
(For professional mode information, please refer to Installation manual)

Select **Setup > TV settings > Sound > Advanced > HDMI 1 -ARC**.

2.5

Blu-ray Disc player

Use a High speed HDMI cable to connect the Blu-ray Disc player to the TV.

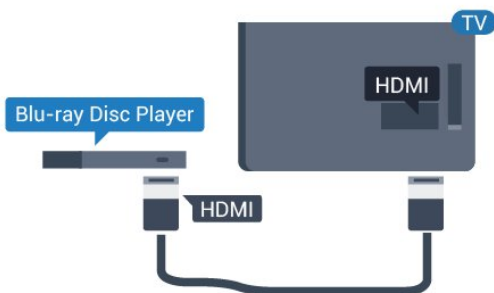

If the Blu-ray Disc player has EasyLink HDMI CEC, you can operate the player with the TV remote control.

2.6

DVD player

Use an HDMI cable to connect the DVD player to the TV.

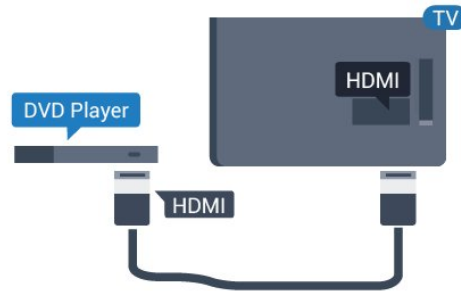

If the DVD player is connected with HDMI and has EasyLink CEC, you can operate the player with the TV remote control.

2.7

Game console

HDMI

For best quality, connect the game console with an High speed HDMI cable to the TV.

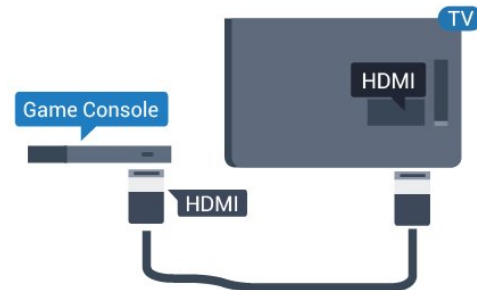

Y Pb Pr - Audio L R

Connect the game console with a component video cable (Y Pb Pr) and an audio L/R cable to the TV.

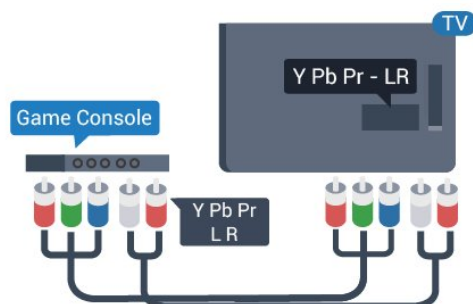

CVBS - Audio L R

Connect the game console to the TV with a composite cable (CVBS) and an audio L/R cable to the TV.

Best Setting

Before you start playing a game from a connected game console, we advice you to set the TV in the ideal setting **Game**.

To set the TV to the ideal setting...

1. Consumer Mode: On – Press **HOME**.
Guest Mode: On – Guest Menu: Not available in Guest Menu.
(For professional mode information, please refer to Installation manual)
 2. Select **Setup > TV settings > Picture > Advanced > Activity style**.
 3. Select **Game, Computer or TV**. The setting **TV** returns to the picture settings for watching TV.
 4. Press **BACK**, repeatedly if necessary, to close the menu.
-

2.8

USB flash drive

You can view photos or play your music and videos from a connected USB flash drive.

Insert a USB flash drive in one of the **USB** connections on the TV while the TV is switched on.



The TV detects the flash drive and opens a list showing its content.

If the contents list does not appear automatically, press **HOME**, select **SOURCES**, select **USB** and press **OK**.

To stop watching the USB flash drive content, press **TV EXIT** or select another activity.

To disconnect the USB flash drive, you can pull out the flash drive anytime.

2.9

Camcorder

HDMI

For best quality, use an HDMI cable to connect the camcorder to the TV.

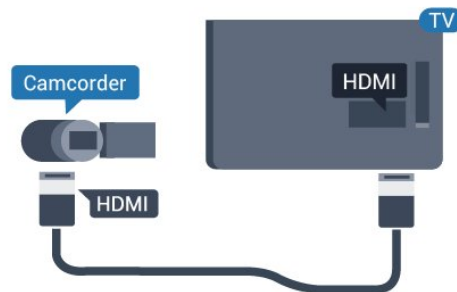

CVBS - Audio L R

Use a Video Audio L/R cable to connect the camcorder to the TV.

2.10

Computer

Connect

You can connect your computer to the TV and use the TV as a PC monitor.

With HDMI

Use an HDMI cable to connect the computer to the TV.

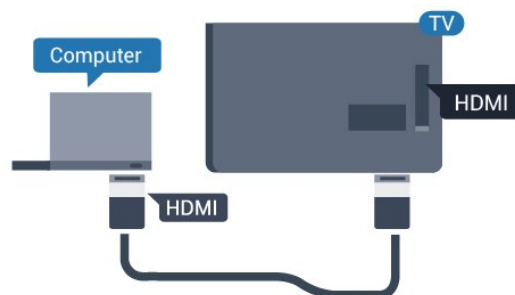

With DVI to HDMI

Alternatively, you can use a DVI to HDMI adapter to connect the PC to HDMI and an audio L/R cable (minijack 3.5mm) to AUDIO IN L/R on the back of the TV.

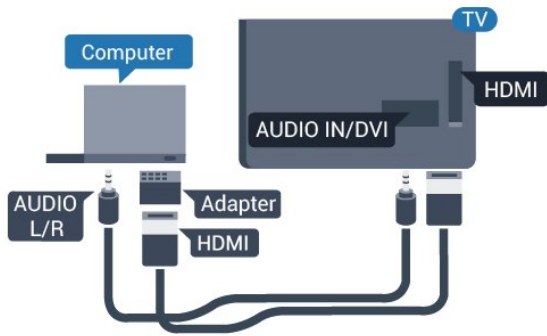

▶ (right) key on the remote control to select Headphone. To adjust headphone volume, please press 🔊 + or 🔊 - on the remote control.

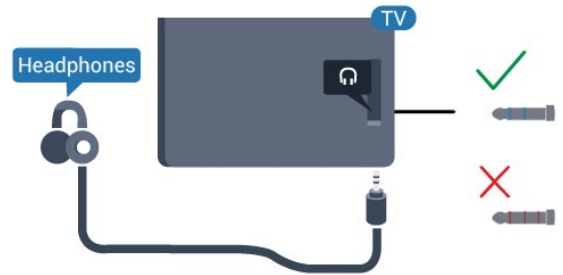

Best Setting

Ideal monitor setting

If your computer is added as a Computer type of device in the Source menu (the list of connections), the TV is set to the ideal Computer setting automatically.

If you use your computer to watch movies or use it to play games, you might want to set the TV back to the ideal TV watching or gaming setting.

To set the TV to the ideal setting manually . . .

1. Consumer Mode: On – Press **HOME**.
Guest Mode: On – Guest Menu: Not available in Guest Menu.
(For professional mode information, please refer to Installation manual)
2. Select **Setup > TV settings > Picture > Advanced > Activity style**.
3. Select **Game, Computer or TV**. The setting **TV** returns to the picture settings for watching TV.
4. Press **BACK**, repeatedly if necessary, to close the menu.

Remember to set the Game or computer setting back to **Computer** when you stop playing the game.

2.11

Headphones

You can connect a set of headphones to  connection on the TV. The connection is a mini-jack 3.5mm. You can adjust the volume of the headphones separately.

To adjust the volume . . .

Press **SETTINGS** on the remote control to access quick settings, select **Headphones volume**, use the **▲** (up) or **▼** (down) keys on remote control to adjust the volume.

Or

Press volume key  on your remote control, the audio independent bar will appear. Press **◀** (left) or

Switch on

3.1

On, Standby or Off

Before you switch on the TV, make sure you plugged in the mains power in the **POWER** connector on the back of the TV.

To put the TV in Standby when the indicator light is off, press the small joystick key on the back of the TV. The indicator will light up.



With the TV in standby, press  on the remote control to switch the TV on.

Switch to standby

To switch the TV to Standby, press  on the remote control.

Switch Off

The TV is still connected to the mains power but consumes very little energy.

To switch off the TV completely, disconnect the power plug.



When disconnecting the power plug, always pull the power plug, never the cord. Ensure that you have full access to the power plug, power cord and outlet socket at all times.

3.2

Keys on TV

If you lost the remote control or its batteries are empty, you can still do some basic TV operations.

To open the basic menu...

1. With the TV switched on, press the joystick key on the back of the TV to bring up the basic menu.
2. Press left or right to select  Volume,  Channel or  Source.
3. Press up or down to adjust the volume or tune to the next or previous channel. Press up or down to go through the list of sources, including the tuner selection.

4. The menu will disappear automatically.

To switch the TV off, select  and press the joystick key.

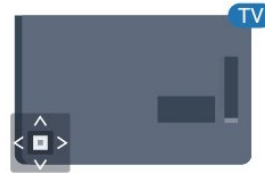



3.3

Sleep timer

With the sleep timer, you can set the TV to switch to standby automatically after a preset time.

To set the sleep timer . . .

1. Consumer Mode: On – Press  HOME.
Guest Mode: On – Guest Menu: Press  HOME.
(For professional mode information, please refer to Installation manual)
2. Select **Setup > TV settings / General settings > General settings > Sleep timer**.
With the slider bar you can set the time to up to 180 minutes in increments of 5 minutes. If set to 0 minutes, the sleep timer is switched off. You can always switch off your TV earlier or reset the time during the countdown.
3. Press , repeatedly if necessary, to close the menu.





3.4

Switch Off Timer

If the TV receives a TV signal but you don't press a key on the remote control during a 4 hour period, the TV switches off automatically to save energy. Also, if the TV does not receive a TV signal nor a remote control command for 10 minutes, the TV switches off automatically.

If you use the TV as a monitor or use a digital receiver to watch TV (a Set-Top Box - STB) and you do not use the remote control of the TV, you should deactivate this automatic switch off.

To deactivate the Switch Off Timer ...

1. Consumer Mode: On – Press  HOME.
Guest Mode: On – Guest Menu: Not available in Guest Menu.
(For professional mode information, please refer to Installation manual)
2. Select **Seutp > TV settings > General settings > Switch off timer.**
3. Press  (up) or  (down) to adjust the value. The value 0 deactivates the automatic switch off.
4. Press , repeatedly if necessary, to close the menu.

Remote control

Key overview

Top

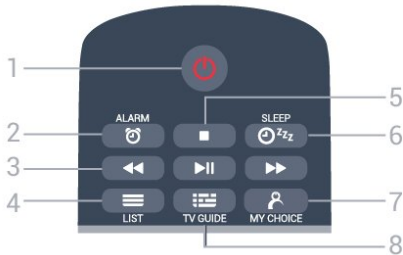

1 - Standby / On

To switch the TV on or back to Standby.

2 - ALARM

To set the alarm.

3 - Playback keys

- Rewind , to rewind.
- Play , to playback.
- Pause , to pause playback.
- Fast forward , to go fast forward.

4 - LIST

To open the channel list.

5 - Playback key

- Stop , to stop playback.

6 - SLEEP

To open the Sleep Timer list.

7 - MY CHOICE

To switch on mychoice.

8 - TV GUIDE

To open or close the TV Guide.

Middle



1 - SMART INFO

To open the smart information page.

2 - Colour keys

Direct selection of options. Blue key , opens Help.

3 - INFO

To open or close programme info.

4 - BACK

To switch back to the previous channel you selected.

To close a menu without changing a setting.

To go back to the previous App/Internet page.

5 - HOME

To open the Home menu.

6 - SETTINGS

To open the Quick settings menu.

7 - OPTIONS

To open or close the Options menu.

8 - OK key

To confirm a selection or setting.

9 - Arrow / navigation keys

To navigate up, down, left or right.

10 - EXIT

To switch back to watching TV. To leave an interactive TV application.

Bottom

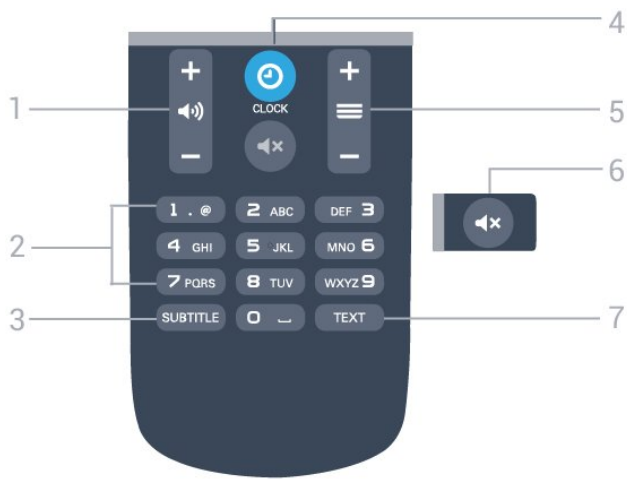

1 - Volume

To adjust the volume level.

2 - Number keys

To select a channel directly.

3 - SUBTITLE

To switch Subtitles on, off or on during mute.

4 - CLOCK

To display the clock.

5 - Channel

To switch to the next or previous channel in the channel list. To open the next or previous page in Text/Teletext. To start the next or previous chapter on a disc.

6 - Mute

To mute the sound or to restore it.

7 - TEXT

To open or close Text/Teletext.

4.2

IR sensor

The TV can receive commands from a remote control that uses IR (infrared) to send commands. If you use such a remote control, always make sure you point the remote control at the infrared sensor on the front of the TV.

4.3

Batteries

1. Slide the battery door in the direction shown by the arrow.

2. Replace the old batteries with 2 type AAA-LR03-1.5V batteries. Make sure the + and the - ends of the batteries line up correctly.

3. Reposition the battery door.

4. Slide it back until it clicks.

Remove the batteries if you are not using the remote control for a long time.

Safely dispose of your old batteries according to the end of use directions.

4.4

Cleaning

Your remote control is treated with a scratch-resistant coating.

To clean the remote control, use a soft damp cloth. Never use substances such as alcohol, chemicals or household cleaners on the remote control.

TV channels

5.1

Channel Lists

About channel lists

After a channel installation, all channels appear on the channel list. Channels are shown with their name if this information is available.

With a channel list selected, press the arrows ▲ (up), ▼ (down), ◀ (left) and ▶ (right) to select a channel, then press **OK** to watch the selected channel. You only tune to the channels in that list when using **≡ +** or **≡ -** keys.

Channel icons

After an Automatic Channel Update of the channel list, newly found channels are marked with a ★ (star).
If you lock a channel, it will be marked with a 🔒 (lock).

Radio stations

If digital broadcasting is available, digital radio stations are installed during installation. Switch to a radio channel just like you switch to a TV channel. A Cable (DVB-C) channel installation usually places radio stations from channel number 1001 onwards.

Open a channel list

To open the current channel list...

1. Press **TV**, to switch to TV.
2. Press **≡ LIST** to open the current channel list.
3. Press **≡ LIST** again to close the channel list.

5.2

Watching TV channels

Watching channels

Tune to a channel

To watch TV channels, press **TV**. The TV tunes to the TV channel you last watched.

Switch channels

- To switch channels, press **≡ +** or **≡ -**.
- If you know the channel number, type in the number with the number keys. Press **OK** after you entered the number to switch immediately.

Previous channel

- To switch back to the previously tuned channel, press **↶**.

Channel list

While watching a TV channel, press **≡ LIST** to open the channel lists.

The channel list can have several pages with channels. To view the next or previous page, press **≡ +** or **≡ -**.

To close the channel lists without switching channel, press **≡ LIST** again.

Radio channels

If digital broadcasting is available, digital radio station are installed during installation. Switch to a radio channel just like you switch to a TV channel.

Channel options

Open options

While watching a channel, you can set some options.

Depending on the type of channel you are watching (analogue or digital) or depending on the TV settings you made, some options are available.

To open the options menu...

1. While watching a channel, press **≡ OPTIONS**.
2. Press **≡ OPTIONS** again to close.

Subtitles and subtitle language

Switch On

To switch on Subtitles, press **SUBTITLE**.

You can set subtitles to **Subtitles off**, **Subtitles on**, or **Automatic**.

Automatic

If language information is part of the digital broadcast and the broadcasted programme is not in your language (the language set on TV), the TV can show subtitles automatically in one of your preferred subtitle languages. One of these subtitle languages must also be part of the broadcast.

You can select your preferred subtitle languages in **Subtitle Language**.

Preferred subtitle languages

Subtitles for digital channels

There is no need to set subtitles in Text for digital channels.

Digital channels can offer several subtitle languages for a programme. You can set a preferred primary and secondary subtitle language. If subtitles in one of these languages are available, the TV will show them. If none of the preferred subtitle languages are available, you can select another subtitle language which is available.

To set the primary and secondary subtitle language...

1. Consumer Mode: On – Press **HOME**.
Guest Mode: On – Guest Menu: Not available in Guest Menu.
(For professional mode information, please refer to Installation manual)
2. Select **Setup > Channel settings** and select **Languages**.
3. Select **Primary subtitles** or **Secondary subtitles** and press **OK**.
4. Select a language and press **OK**.
5. Press **↔**, repeatedly if necessary, to close the menu.

Select a subtitle language

If none of the preferred subtitle languages are available, you can select another subtitle language if available. If no subtitle languages are available, you cannot select this option.

To select a subtitle language when none of your preferred languages are available...

1. Press **≡** **OPTIONS**.
2. Select **Subtitle language** and select one of the languages as subtitles temporarily.

Subtitles for analogue channels

For analogue channels, you need to make the subtitles available for each channel manually.

1. Switch to a channel and press **TEXT** to open Text.
2. Enter the page number for subtitles, usually **888**.
3. Press **TEXT** again, to close Text.

If you select On in the Subtitle menu when watching this analogue channel, subtitles will be shown if available.

To know if a channel is analogue or digital, switch to the channel and open **Status** in the **Options** menu.

Audio language

Preferred audio language

Digital TV channels can broadcast audio with several spoken languages for a programme. You can set a preferred primary and secondary audio language. If audio in one of these languages is available, the TV will switch to this audio.

If none of the preferred audio languages is available, you can select another audio language which is available.

To set the primary and secondary audio language...

1. Consumer Mode: On – Press **HOME**.
Guest Mode: On – Guest Menu: Not available in Guest Menu.
(For professional mode information, please refer to Installation manual)
2. Select **Setup > Channel settings** and select **Languages**.
3. Select **Primary audio** or **Secondary audio** and press **OK**.
4. Select a language and press **OK**.
5. Press **↔**, repeatedly if necessary, to close the menu.

Select an audio language

To select an audio language when none of your preferred audio language is available...

1. Press **≡** **OPTIONS**.
2. Select **Audio language** and select an audio language you want temporarily and press **OK**.

Audio languages for the hearing and visually impaired

Some digital TV channels broadcast special audio and subtitles adapted for people who are hearing or visually impaired.

Video selection

Digital TV channels can offer multi video signals (multifeed broadcast), different camera viewpoints or angles of the same event or different programmes on one TV channel. The TV shows a message if any such TV channels are available.

Dual I-II

If an audio signal contains two audio languages but one language – or both – has no language indication, this option is available.

Common Interface

If prepaid premium content is available from a CAM, you can set the provider settings with this option.

Status

Select **Status** to view technical information on the channel (if it is analogue or digital) or a connected device you are watching.

Favourite channels

About favourite channels

You can create a favourite channel list that only holds the channels you want to watch. With the Favourite channel list selected, you will only see your favourite channels when you switch through channels.

Create a favourites list

1. While watching a TV channel, press **≡ LIST** to open the channel list.
2. Select **All** to view all channels.
3. Select the channel, and press **■** (yellow) to mark as favourite.
4. The selected channel is marked with a **♥**.
5. To finish, press **↩**. The channels are added to the Favourites list.

To remove a channel from the favourites list, select the channel with **♥**, then press **■** (yellow) again to unmark as favourite.

Rename channels

You can rename channels in the channel list.

1. Select the channel you want to rename in one of the channel lists.
2. Press **■** (red).
3. You can enter text with the the on-screen keyboard.

Text / Teletext

Text pages

To open Text (Teletext) while you are watching TV channels, press **TEXT**.
To close Text, press **TEXT** again.

Select a Text page

To select a page...

1. Enter the page number with the number keys.
2. Use the arrow keys to navigate.
3. Press a colour key to select a colour-coded subject at the bottom of the screen.

Text sub-pages

A Text page number can hold several subpages. The subpage numbers are shown on a bar next to the main page number.

To select a subpage, press **◀** or **▶**.

T.O.P. Text pages

Some broadcasters offer T.O.P. Text.

To open T.O.P. Text pages within Text, press **≡** **OPTIONS** and select T.O.P. overview.

Favourite pages

The TV makes a list of the last 10 Text pages you opened. You can easily reopen them again in the Favourite Text pages column.

1. In Text, select the star in the top left corner of the screen to show the column of favourite pages.
 2. Press **▼** (down) or **▲** (up) to select a page number and press **OK** to open the page.
- You can clear the list with the option **Clear favourite pages**.

Search Text

You can select a word and scan Text for all occurrences of this word.

1. Open a Text page and press **OK**.
2. Select a word or number with the arrow keys.
3. Press **OK** again to jump immediately to the next occurrence of this word or number.
4. Press **OK** again to jump to the subsequent occurrence.
5. To stop searching, press **▲** (up) until nothing is selected.

Text from a connected device

Some devices that receive TV channels can also offer Text.

To open Text from a connected device...

1. Press **▲**, select the device and press **OK**.
2. While watching a channel on the device, press **≡** **OPTIONS**, select **Show device keys** and select the **■** key and press **OK**.
3. Press **↩** to hide the device keys.
4. To close Text, press **↩** again.

Digital Text (UK only)

Some digital broadcasters offer dedicated Digital Text or interactive TV on their digital TV channels. This includes normal Text using the number, colour and arrow keys to select and navigate.

To close Digital Text, press **↩**.

Text options

In Text, press **≡** **OPTIONS** to select the following . . .

- Freeze page / Unfreeze page

To stop the automatic rotation of subpages.

- Dual screen / Full screen

To show the TV channel and Text alongside each other.

- **T.O.P. overview**

To open T.O.P. Text.

- **Enlarge / Normal view**

To enlarge the Text page for comfortable reading.

- **Reveal**

To unhide hidden information on a page.

- **Cycle subpages**

To cycle subpages when these are available.

- **Language**

To switch the group of characters that Text uses to display correctly.

- **Text 2.5**

To activate the Text 2.5 for more colours and better graphics.

Text setup

Text language

Some digital TV broadcasters have several Text languages available.

To set your primary and secondary Text language . . .

1. Consumer Mode: On – Press **HOME**.

Guest Mode: On – Guest Menu: Not available in Guest Menu.

(For professional mode information, please refer to Installation manual)

2. Select **Setup > Channel settings > Languages**.

3. Select **Primary Teletext** or **Secondary Teletext**.

4. Select your preferred Text languages.

5. Press **↩**, repeatedly if necessary, to close the menu.

Text 2.5

If available, Text 2.5 offers more colours and better graphics. Text 2.5 is activated as a standard factory setting.

To switch off Text 2.5 . . .

1. Press **TEXT**.

2. While watching the teletext, press **≡** **OPTIONS**.

3. Select **Text 2.5 > Off**.

4. Press **↩**, repeatedly if necessary, to close the menu.

Channel installation

- Antenna, Cable

Update channels

Automatic update

If you receive digital channels, you can set the TV to automatically update the list with new channels. Alternatively, you can start a channel update yourself.

Automatic channel update

Once a day, at 6 AM, the TV updates the channels and stores new channels. New channels are stored in the All channels list. Empty channels are removed. If new channels are found or if channels are updated or removed, a message is shown at TV start up. The TV must be in standby to automatically update channels.

To switch off the message at start up . . .

1. Consumer Mode: On – Press **HOME**.
Guest Mode: On – Guest Menu: Not available in Guest Menu.
(For professional mode information, please refer to Installation manual)
2. Select **Setup > Channel settings > Channel settings** and press **OK**.
3. Select **Channel update message > Off**.

To switch off the Automatic channel update . . .

1. Consumer Mode: On – Press **HOME**.
Guest Mode: On – Guest Menu: Not available in Guest Menu.
(For professional mode information, please refer to Installation manual)
2. Select **Setup > Channel settings > Channel settings** and press **OK**.
3. Select **Automatic channel update > Off**.

Start an update

To start an update yourself . . .

1. Consumer Mode: On – Press **HOME**.
Guest Mode: On – Guest Menu: Not available in Guest Menu.
(For professional mode information, please refer to Installation manual)
2. Select **Search for channels** and press **OK**.
3. Select **Update channels** and follow the instructions on screen. The update may take a few minutes.

In certain countries, the Automatic channel update is done while watching TV or any moment when the TV is in standby.

Reinstall channels

Reinstall All Channels

You can reinstall all channels and leave all other TV settings untouched.

If a PIN code is set, you will need to enter this code before you can reinstall channels.

To reinstall channels..

1. Consumer Mode: On – Press **HOME**.
Guest Mode: On – Guest Menu: Not available in Guest Menu.
(For professional mode information, please refer to Installation manual)
2. Select **Search for channels > Re-install Channels** follow the instructions on screen. The update may take a few minutes.

Reinstall TV

You can redo a full TV installation. The TV is completely reinstalled.

To redo a full TV installation..

1. Consumer Mode: On – Press **HOME**.
Guest Mode: On – Guest Menu: Not available in Guest Menu.
(For professional mode information, please refer to Installation manual)
2. Select **Setup > TV settings > General settings > Reinstall TV** and press **OK**. The installation may take a few minutes. Follow the instructions on screen.

DVB-T or DVB-C

DVB-T or DVB-C reception

DVB Settings

Access DVB settings

1. Consumer Mode: On – Press **▲ HOME**.
- Guest Mode: On – Guest Menu: Not available in Guest Menu.
(For professional mode information, please refer to Installation manual)
2. Select **Search for channels** and press **OK**.
3. Select **Re-install Channels**.
4. Select the country where you install this TV.
5. Select **Cable (DVB-C)**.
6. Select **Start to search channels**, or select **Settings for DVB-C settings**.
7. Press **↵**, repeatedly if necessary, to close the menu.

Symbol rate mode

If your cable provider did not give you a specific **symbol rate** value to install the TV channels, leave the **Symbol rate mode** setting on **Automatic**.

If you received a specific symbol rate value, select **Manual**. However, the value you received could be in the predefined list of symbol rates already. Select **Predefined symbol rates** to check if your value is available automatically.

Symbol rate

With the **Symbol rate mode** set to **Manual**, you can enter the symbol rate value you received from your cable provider. To enter the value, use the number keys.

Network frequency

With **Frequency scan** set to **Quick** or **Advanced**, you can enter here the network frequency value received from your cable provider. To enter the value, use the number keys.

Frequency scan

Select the method of searching for channels. You can select the faster **Quick** scan method and use the predefined settings used by most cable providers in your country.

If this results in having no channels installed or if some channels are missing, you can select the extended **Full scan** method. This method will take more time to search for and install channels.

Network ID

With **Frequency scan** set to **Quick**, you can enter here the network ID value received from your cable provider. To enter the value, use the number keys.

Digital channels

If you know your cable provider is not offering digital channels, you can skip searching for digital channels. Select **Off**.

Analogue channels

If you know your cable provider is not offering analogue channels, you can skip searching for analogue channels. Select **Off**.

Free / Scrambled

If you have a subscription and a CAM - Conditional Access Module for pay TV services, select **Free + scrambled**. If you did not subscribe to pay TV channels or services, you can select **Free channels only**.

TV guide

7.1

What you need

With the TV guide you can view a list of the current and scheduled TV programmes of your channels. Depending on where the TV guide information (data) is coming from, analogue and digital channels or only digital channels are shown. Not all channels offer TV guide information.

The TV can collect TV guide information for the channels that are installed on the TV (e.g the channels you watch with Watch TV). The TV cannot collect the TV guide information for channels viewed from a digital receiver.

7.2

Using the TV guide

Open the TV guide

To open the TV guide, press  TV GUIDE.

Press  TV GUIDE again to close.

The first time you open the TV guide, the TV scans all TV channels for programme information. This may take several minutes. TV guide data is stored in the TV.

Tune to a programme

Switch to a programme

From the TV guide, you can switch to a current programme.

To select a programme, use the arrow keys to highlight the programme name.

Navigate to the right to view programmes scheduled later that day.



To switch to the programme (channel), select the programme and press OK.

View programme details

To call up the details of the selected programme, press  INFO .

Change day

The TV guide can show scheduled programmes for the upcoming days (maximum up to 8 days).

If the TV guide information comes from the broadcaster, you can press  + to view the schedule of one of the next days. Press  - to go back to the previous day.

Alternatively, you can press  OPTIONS and select **Change day**.



Select **Previous day**, **Today** or **Next day** and press OK, to select the day of the schedule.

Set a reminder



You can set a reminder for a programme. A message will alert you at the start of the programme. You can tune to this channel immediately.

In the TV Guide a programme with a reminder is marked with a  (clock).

To set a reminder...

1. Press  TV GUIDE and select an upcoming programme.
2. Press  OPTIONS.
3. Select **Set reminder** and press OK.

To clear a reminder...

1. Press  TV GUIDE and select a programme with the reminder.
2. Press  OPTIONS.
3. Select **Clear reminder** and press OK.

Search by genre

If the information is available, you can look up scheduled programmes by genre like movies, sports, etc.

To search for programmes by genre, press  OPTIONS and select **Search by genre**.

Select a genre and press OK. A list with the found programmes appears.

Sources

8.1

Switch to a device

In the list of connections - the Source menu - you can find the devices connected to the TV. From this Source menu, you can switch to a device.

Sources menu

To open the Sources menu, press **▲ HOME**, then select **▶ SOURCES**.

To switch to a connected device, select the device with the arrows **◀** (left) or **▶** (right) and press **OK**.

To close the Source menu without switching to a device, select **▶ SOURCES** again.

8.2

From standby

With the TV in standby, you can switch on a connected device with your TV remote control.

Play

To switch on both disc player and TV from standby and start playing the disc or programme immediately, press **▶** (play) on the TV remote control.

The device should be connected with an HDMI cable and both TV and device must have HDMI CEC switched on.

Home Theatre System

You can switch on your Home Theatre System to listen to an audio disc or a radio channel and leave the TV in standby.

To only switch on the HTS, with the TV in standby, press **▲ HOME** on the TV remote control, then select **▶ SOURCES**.

8.3

EasyLink

With EasyLink you can operate a connected device with the TV remote control. EasyLink uses HDMI CEC to communicate with the connected devices. Devices must support HDMI CEC and must be connected with an HDMI connection.

Timers and clock

9.1

Sleep timer

With the sleep timer, you can set the TV to switch to standby automatically after a preset time.

To set the sleep timer . . .

1. Consumer Mode: On – Press **HOME**.

Guest Mode: On – Guest Menu: Not available in Guest Menu.

(For professional mode information, please refer to Installation manual)

2. Select **Setup > TV settings > General settings > Sleep timer**.

With the slider bar you can set the time to up to 180 minutes in increments of 5 minutes. If set to 0 minutes, the sleep timer is switched off. You can always switch off your TV earlier or reset the time during the countdown.

3. Press **BACK**, repeatedly if necessary, to close the menu.

9.2

Clock

To know what time it is, press **CLOCK** on the remote control to find the time on TV screen.

In some countries, digital broadcasts do not send UTC – Coordinated Universal Time information. The daylight saving change might be ignored and the TV might show an incorrect time.

To correct the TV clock...

1. Consumer Mode: On – Press **HOME**.

Guest Mode: On – Guest Menu: Not available in Guest Menu.

(For professional mode information, please refer to Installation manual)

2. Select **Setup > TV settings > General settings > Clock > Auto clock mode** and select Country dependent.

Switch off timer

If you do not press a key on the remote control during a 4 hour period, or if the TV receives no input signal nor remote control commands for 10 minutes, the TV switches off automatically to save energy.

If you use the TV as a monitor or use a digital receiver to watch TV (a Set-top box – STB) and you do not use the remote control of the TV, you should deactivate the automatic switch off.

To deactivate the **Switch off timer**...

1. Consumer Mode: On – Press **HOME**.

Guest Mode: On – Guest Menu: Not available in Guest Menu.

(For professional mode information, please refer to Installation manual)

2. Select **Setup > TV settings > General settings > Switch off timer** and set the slider bar to 0 (Off).

3. Press **BACK**, repeatedly if necessary, to close the menu.

Videos, Photos and Music

From a USB connection

You can view your photos or play your music and videos from a connected USB flash drive or USB Hard Drive.

With the TV switched on, plug in a USB flash drive or a USB Hard Drive to one of the USB connections. The TV detects the device and will list your media files.

If the list of files does not appear automatically...

1. Press **HOME**, then select **SOURCES**, select **USB** and press **OK**.
2. Select **USB Devices** and press **▶** (right) to select the USB device you need.

You can browse your files in the folder structure you have organised on the drive.

To stop playing videos, photos and music, press **TV EXIT**.

Warning

If you try to pause or record a programme with a USB Hard Drive connected, the TV will ask you to format the USB Hard Drive. This formatting will delete all current files on the USB Hard Drive.

Play your videos

Play videos

How you open the list of your media files on TV depends on the type of device where the files are stored. See the chapters above.

To play a video on TV...

Select **Videos**, and select the file name and press **OK**.

- To pause the video, press **OK**. Press **OK** again to continue.
- To rewind or go fast forward, press **▶▶** or **◀◀**. Press the keys several times to speed up - 2x, 4x, 8x, 16x, 32x.
- To jump to the next video in a folder, press **OK** to pause and select **▶** on screen and press **OK**.
- To stop the video playback, press **■** (Stop).
- To go back to the folder, press **◀**.

Progress Bar

To show the progress bar when a video is playing (playhead position, duration, title, date, etc.), press

INFO.

Press again to hide the info.

Video options

During the video playback, press **≡** **OPTIONS** to...

- Subtitles

Display the subtitles if available.

- Audio language

Play the audio language if available.

- Repeat, Play once

Play videos repeatedly or once.

- Shuffle on, Shuffle off

Play videos in sequence or at random.

- Show info

Display the file name.

- Subtitle settings

Set subtitle colour and position if available.

View your photos

View photos

How you open the list of your media files on TV depends on the type of device where the files are stored. See the chapters above.

To view all photos on TV...

Select **Photos**, and select **All** and press **OK**.

To view a photo on TV...

Select **Photos**, and select the file name and press **OK**.

To start a slide show on TV...

If there are several photos in a folder, you can start a slide show.

To start a slide show...

1. Select the folder with photos.
2. Press the colour key **Slide Show**.
 - To jump to the next or previous photo, press **▶** (right - next) or **◀** (left - previous).
 - To pause the slide show, press **OK**. To start again, press **OK** again.
 - To stop the slide show, press **OK** and press **◀**.

Info

To view info on a photo (size, creation date, file path, etc.), select a photo and press **INFO**. Press again to hide the info.

Slideshow with music

You can watch a slideshow of your photos and listen to your music at the same time. You must start the music before you start the photo slideshow.

To play music with the slide show...

1. Select a song or a folder with songs and press **OK**.
2. Press **INFO** to hide file info and progress bar.
3. Press **↩**.
4. Now use the navigation arrows to select the folder with photos.
5. Select the folder with photos and press **Slide Show**.
6. To stop the slideshow, press **↩**.

Photo options

With a photo on screen, press **≡ OPTIONS** to...

- **Start slideshow, Stop slideshow**
Start or stop slideshow.
- **Slideshow transitions**
Set the transition from one picture to the next.
- **Slideshow frequency**
Select the display time for each photo.
- **Repeat, Play once**
View the pictures repeatedly or once only.
- **Shuffle off, Shuffle on**
View the pictures in sequential order, or at random.
- **Rotate image**
Rotate photo.
- **Show info**
Display the picture name, date, size and next picture in the slide show.
- **Stop music**
Stop the music playing in the background.

10.4

Play your music

Play music

How you open the list of your media files on TV depends on the type of device where the files are stored. See the chapters above.

To play a song on TV...

Select **🎵 Music**, and select the file name and press **OK**.

If there are several songs in a folder, you can listen to them one after the other.

- To pause a song, press **OK**. Press **OK** again to

continue.

- To rewind or go fast forward, press **▶▶** or **◀◀**. Press the keys several times to speed up - 2x, 4x, 8x, 16x, 32x.

- To jump to the next song in a folder, press **OK** to pause and select **▶** on screen and press **OK**.

- To go back to the folder, press **↩**, the music will keep on playing.

- To stop the music playback, press **■** (Stop).

Progress Bar

To show the progress bar when a song is playing (playhead position, duration, title, date, etc.), press **INFO**. Press again to hide the info.

Music options

Options for playing music...

- **Stop playback**
Stop music play.
- **Repeat, Play once**
Play songs repeatedly or once.
- **Shuffle on, Shuffle off**
Play songs in sequence or at random.
- **Show info**
Display the file name.

Settings

Picture

Picture style

Select a style

For easy picture adjustment, you can select a preset Picture Style.

1. Consumer Mode: On – Press **▲** HOME.
Guest Mode: On – Guest Menu: Press **▲** HOME.
(For professional mode information, please refer to Installation manual)
2. Select **Setup > TV settings / General settings > Picture > Picture style**, and select one of the styles in the list.
3. Select a style and press **OK**.

The available Picture styles are...

- **Personal** – The picture preferences you set during the first start up.
- **Vivid** – Ideal for daylight viewing
- **Natural** – Natural picture settings
- **Standard** – Most energy conscious setting – Factory setting
- **Movie** – Ideal for watching movies
- **Photo** – Ideal for viewing photos
- **Energy saving** – ideal for energy saving

Customise a style

Any picture setting you adjust, like **Colour** or **Contrast**, is stored in the currently selected Picture style. It allows you to customise each style.

Restore a style

The selected style will store the changes you made. We recommend to adjust the picture settings for the style **Personal** only. The Picture style – **Personal** can save its settings for each individual connected device in **Sources** menu.

To restore the style to its original setting...

1. Consumer Mode: On – Press **▲** HOME.
Guest Mode: On – Guest Menu: Press **▲** HOME.
(For professional mode information, please refer to Installation manual)
2. Select **Setup > TV settings / General settings > Picture > Restore style**, and select the Picture Style you want to restore.
3. Press **OK**. The style is restored.

Home or Shop

If the **Picture** style is switched back to **Vivid** every time you switch on the TV, the TV location is set to **Shop**. A setting meant for in-store promotion.

To set the TV for Home use...

1. Consumer Mode: On – Press **▲** HOME.
Guest Mode: On – Guest Menu: Not available in Guest Menu.
(For professional mode information, please refer to Installation manual)
2. Select **Setup > TV settings > General settings > Location** and press **OK**.
3. Select **Home** and press **OK**.
4. Press **↔**, repeatedly if necessary, to close the menu.

Picture settings

Colour

With **Colour**, you can adjust the colour saturation of the picture.

To adjust the colour...

1. Consumer Mode: On – Press **▲** HOME.
Guest Mode: On – Guest Menu: Press **▲** HOME.
(For professional mode information, please refer to Installation manual)
2. Select **Setup > TV settings / General settings > Picture > Colour**.
3. Press **▶** (right) and adjust the value with **▲** (up) or **▼** (down).
4. Press **↔**, repeatedly if necessary, to close the menu.

Contrast

With **Contrast**, you can adjust the brightness of the display backlight.

To adjust the level...

1. Consumer Mode: On – Press **▲** HOME.
Guest Mode: On – Guest Menu: Press **▲** HOME.
(For professional mode information, please refer to Installation manual)
2. Select **Setup > TV settings / General settings > Picture > Contrast**.
3. Press **▶** (right) and adjust the value with **▲** (up) or **▼** (down).
4. Press **↔**, repeatedly if necessary, to close the menu.

Sharpness

With **Sharpness**, you can adjust the level of sharpness in fine detail of the picture.

To adjust the sharpness...

1. Consumer Mode: On – Press **↑ HOME**.
Guest Mode: On – Guest Menu: Press **↑ HOME**.
(For professional mode information, please refer to Installation manual)
2. Select **Setup > TV settings / General settings > Picture > Sharpness**.
3. Press **▶** (right) and adjust the value with **▲** (up) or **▼** (down).
4. Press **↵**, repeatedly if necessary, to close the menu.

Advanced picture settings

Game or computer

When you connect a device, the TV recognizes its type and gives each device a correct type name. You can change the type name if you wish. If a correct type name for a device is set, the TV automatically switches to the ideal TV settings when you switch to this device in the Sources menu.

If you have a game console with a built-in Blu-ray Disc player, you might have set the type name to Bluray Disc. With **Activity style** you can switch to the ideal settings for gaming manually. Don't forget to switch to **TV**, when you return to watch TV.

To switch the setting manually...

1. Consumer Mode: On – Press **↑ HOME**.
Guest Mode: On – Guest Menu: Not available in Guest Menu.
(For professional mode information, please refer to Installation manual)
2. Select **Setup > TV settings > Picture > Advanced > Activity style**.
3. Select **Game, Computer** or **TV**. The setting **TV** returns to the picture settings for watching TV.
4. Press **↵**, repeatedly if necessary, to close the menu.

Colour settings

Colour enhancement

With **Colour enhancement**, you can enhance the colour intensity and the details in bright colours.

To adjust the level...

1. Consumer Mode: On – Press **↑ HOME**.
Guest Mode: On – Guest Menu: Not available in Guest Menu.
(For professional mode information, please refer

to Installation manual)

2. Select **Setup > TV settings > Picture > Advanced > Colour**.
3. Select **Colour enhancement** and press **OK**.
4. Select **Maximum, Medium, Minimum** or **Off**.
5. Press **↵**, repeatedly if necessary, to close the menu.

Colour temperature

With **Colour temperature**, you can set the picture to a preset colour temperature or select **Custom** to set a temperature setting yourself with **Custom colour temperature**. **Colour temperature** and **Custom colour temperature** are settings intended for expert users.

To select a preset...

1. Consumer Mode: On – Press **↑ HOME**.
Guest Mode: On – Guest Menu: Not available in Guest Menu.
(For professional mode information, please refer to Installation manual)
2. Select **Setup > TV settings > Picture > Advanced > Colour**.
3. Select **Colour Temperature** and press **OK**.
4. Select **Normal, Warm** or **Cool**. Or select **Custom** if you want to customise a colour temperature yourself.
5. Press **↵**, repeatedly if necessary, to close the menu.

Custom colour temperature

With **Custom colour temperature**, you can set a colour temperature yourself. To set a custom colour temperature, first select **Custom** in the **Colour temperature** menu. **Custom colour temperature** is a setting intended for expert users.

To set a custom colour temperature...

1. Consumer Mode: On – Press **↑ HOME**.
Guest Mode: On – Guest Menu: Not available in Guest Menu.
(For professional mode information, please refer to Installation manual)
2. Select **Setup > TV settings > Picture > Advanced > Colour**.
3. Select **Custom Colour Temperature** and press **OK**.
4. Press the arrows **▲** (up) or **▼** (down) to adjust the value. **WP** is white point and **BL** is black level. You can also select one of the presets in this menu.
5. Press **↵**, repeatedly if necessary, to close the menu.

Contrast settings

Contrast modes

With **Contrast Mode**, you can set the level at which power consumption can be reduced by dimming the intensity of the screen. Choose for the best power consumption or for the picture with the best intensity.

To adjust the level...

1. Consumer Mode: On – Press **↑ HOME**.
Guest Mode: On – Guest Menu: Not available in Guest Menu.
(For professional mode information, please refer to Installation manual)
2. Select **Setup > TV settings > Picture > Advanced > Contrast > Contrast mode**.
3. Select **Standard, Best power, Best picture**, or **Off**.
4. Press **↔**, repeatedly if necessary, to close the menu.

Dynamic contrast

With **Dynamic Contrast**, you can set the level at which the TV automatically enhances the details in the dark, middle and light areas of the picture.

To adjust the level...

1. Consumer Mode: On – Press **↑ HOME**.
Guest Mode: On – Guest Menu: Not available in Guest Menu.
(For professional mode information, please refer to Installation manual)
2. Select **Setup > TV settings > Picture > Advanced > Contrast > Dynamic contrast**.
3. Select **Maximum, Medium, Minimum** or **Off**.
4. Press **↔**, repeatedly if necessary, to close the menu.

Brightness

With **Brightness**, you can set the level of brightness of the picture signal. **Brightness** is a setting intended for expert users. We recommend non-expert users to adjust the brightness of the picture with the **Contrast** setting.

To adjust the level...

1. Consumer Mode: On – Press **↑ HOME**.
Guest Mode: On – Guest Menu: Not available in Guest Menu.
(For professional mode information, please refer to Installation manual)
2. Select **Setup > TV settings > Picture > Advanced > Contrast > Brightness**.
3. Press **▶** (right) and adjust the value with **▲** (up) or **▼** (down).

4. Press **↔**, repeatedly if necessary, to close the menu.

Video contrast

With **Video Contrast**, you can decrease the range of the video contrast.

To adjust the level...

1. Consumer Mode: On – Press **↑ HOME**.
Guest Mode: On – Guest Menu: Not available in Guest Menu.
(For professional mode information, please refer to Installation manual)
2. Select **Setup > TV settings > Picture > Advanced > Contrast > Video contrast**.
3. Press **▶** (right) and adjust the value with **▲** (up) or **▼** (down).
4. Press **↔**, repeatedly if necessary, to close the menu.

Gamma

With **Gamma**, you can set a non-linear setting for picture luminance and contrast. **Gamma** is a setting intended for expert users.

To adjust the level...

1. Consumer Mode: On – Press **↑ HOME**.
Guest Mode: On – Guest Menu: Not available in Guest Menu.
(For professional mode information, please refer to Installation manual)
2. Select **Setup > TV settings > Picture > Advanced > Contrast > Gamma**.
3. Press **▶** (right) and adjust the value with **▲** (up) or **▼** (down).
4. Press **↔**, repeatedly if necessary, to close the menu.

Sharpness settings

Super resolution

With **Super resolution**, you switch on a superior sharpness in line edges and contours.

To switch on or off...

1. Consumer Mode: On – Press **↑ HOME**.
Guest Mode: On – Guest Menu: Not available in Guest Menu.
(For professional mode information, please refer to Installation manual)
2. Select **Setup > TV settings > Picture > Advanced > Sharpness > Super resolution**.
3. Select **On** or **Off**.
4. Press **↔**, repeatedly if necessary, to close

the menu.

Noise reduction

With **Noise reduction**, you can filter out and reduce the level of image noise.

To adjust the noise reduction...

1. Consumer Mode: On – Press **▲ HOME**.
Guest Mode: On – Guest Menu: Not available in Guest Menu.
(For professional mode information, please refer to Installation manual)
2. Select **Setup > TV settings > Picture > Advanced > Sharpness > Noise reduction**.
3. Select **Maximum, Medium, Minimum** or **Off**.
4. Press **↵**, repeatedly if necessary, to close the menu.

MPEG artefact reduction

With **MPEG artefact reduction**, you can smoothen the digital transitions in the picture. MPEG artefacts are mostly visible as small blocks or jagged edges in images.

To reduce the MPEG artefacts...

1. Consumer Mode: On – Press **▲ HOME**.
Guest Mode: On – Guest Menu: Not available in Guest Menu.
(For professional mode information, please refer to Installation manual)
2. Select **Setup > TV settings > Picture > Advanced > Sharpness > MPEG artefact reduction**.
3. Select **On** or **Off**.
4. Press **↵**, repeatedly if necessary, to close the menu.

Format and edges

Picture format

If black bars appear on top and bottom or on both sides of the picture, you can adjust the picture format to a format that fills the screen.

To change the picture format...

1. Consumer Mode: On – Press **▲ HOME**.
Guest Mode: On – Guest Menu: Press **▲ HOME**.
(For professional mode information, please refer to Installation manual)
2. Select **Setup > TV settings / General settings > Picture > Format and edges > Picture format**.
3. Select a format from the list and press **OK**.
4. Press **↵**, repeatedly if necessary, to close the menu.

Screen edges

With **Screen edges**, you can slightly enlarge the picture to hide distorted edges.

To adjust the edges...

1. Consumer Mode: On – Press **▲ HOME**.
Guest Mode: On – Guest Menu: Not available in Guest Menu.
(For professional mode information, please refer to Installation manual)
2. Select **Setup > TV settings > Picture > Format and edges > Screen edges**.
3. Adjust the value with **▲** (up) or **▼** (down).
4. Press **↵**, repeatedly if necessary, to close the menu.

Picture shift

With **Picture shift**, you can slightly move the position of the picture.

To move the picture...

1. Consumer Mode: On – Press **▲ HOME**.
Guest Mode: On – Guest Menu: Not available in Guest Menu.
(For professional mode information, please refer to Installation manual)
2. Select **Setup > TV settings > Picture > Format and edges > Picture shift**.
3. Adjust the position with **▲** (up), **▼** (down), **▶** (right), or **◀** (left).
4. Press **↵**, repeatedly if necessary, to close the menu.

11.2

Sound

Sound style

Select a style

For easy sound adjustment, you can select a preset setting with **Sound style**.

1. Consumer Mode: On – Press **▲ HOME**.
Guest Mode: On – Guest Menu: Press **▲ HOME**.
(For professional mode information, please refer to Installation manual)

2. Select **Setup > TV settings / General settings > Sound > Sound style**, and select one of the styles in the list.

3. Select a style and press **OK**.

The available Sound styles are...

- **Personal** - The sound preferences you set during the first start up.

- **Original** - Most neutral sound setting

- **Movie** - Ideal for watching movies

- **Music** - Ideal for listening to music

- **Game** - Ideal for gaming

- **News** - Ideal for speech

Restore a style

The selected style will store the changes you made. We recommend to adjust the sound settings for the style **Personal** only. The **Sound Style - Personal** can save its settings for each individual connected device in Sources menu.

To restore the style to its original setting...

1. Consumer Mode: On – Press **HOME**.

Guest Mode: On – Guest Menu: Press **HOME**.

(For professional mode information, please refer to Installation manual)

2. Select **Setup > TV settings / General settings > Sound > Restore style**.

Sound settings

Bass

With **Bass**, you can adjust the level of low tones in the sound.

To adjust the level...

1. Consumer Mode: On – Press **HOME**.

Guest Mode: On – Guest Menu: Not available in Guest Menu.

(For professional mode information, please refer to Installation manual)

2. Select **Setup > TV settings > Sound > Bass**.

3. Press **▶** (right) and adjust the value with **▲** (up) or **▼** (down).

4. Press **↵**, repeatedly if necessary, to close the menu.

Treble

With **Treble**, you can adjust the level of high tones in the sound.

To adjust the level...

1. Consumer Mode: On – Press **HOME**.

Guest Mode: On – Guest Menu: Not available in

Guest Menu.

(For professional mode information, please refer to Installation manual)

2. Select **Setup > TV settings > Sound > Treble**.

3. Press **▶** (right) and adjust the value with **▲** (up) or **▼** (down).

4. Press **↵**, repeatedly if necessary, to close the menu.

Surround mode

With **Surround mode**, you can set the sound effect of the TV speakers.

To set the surround mode...

1. Consumer Mode: On – Press **HOME**.

Guest Mode: On – Guest Menu: Not available in Guest Menu.

(For professional mode information, please refer to Installation manual)

2. Select **Setup > TV settings > Sound > Surround mode**.

3. Press **▶** (right) and select **Stereo** or **Incredible surround**.

4. Press **↵**, repeatedly if necessary, to close the menu.

Headphones volume

With **Headphones volume**, you can set the volume of a connected headphones separately.

To adjust the volume...

Press **SETTINGS** on the remote control to access quick settings, select **Headphones volume**, use the **▲** (up) or **▼** (down) keys on remote control to adjust the volume.

Or

Press volume key **◀▶** on your remote control, the audio independent bar will appear. Press **◀** (left) or **▶** (right) key on the remote control to select **Headphone**. To adjust headphone volume, please press **◀▶** + or **◀▶** - on the remote control.

Advanced sound settings

Auto volume levelling

With **Auto volume leveling**, you can set the TV to automatically level out sudden volume differences. Typically at the beginning of adverts or when you are switching channels.

To switch on or off...

1. Consumer Mode: On – Press **HOME**.

Guest Mode: On – Guest Menu: Not available in

Guest Menu.

(For professional mode information, please refer to Installation manual)

2. Select **Setup > TV settings > Sound > Advanced > Auto volume leveling**.
3. Press **▶** (right) and select **On** or **Off**.
4. Press **↵**, repeatedly if necessary, to close the menu.

TV speakers

You can send the TV sound to a connected audio device - a Home Theatre System or audio system. With **TV speakers**, you select where you want to hear the TV sound and how you want to control it.

- If you select **Off**, you permanently switch off the TV speakers.

- If you select **On**, the TV speakers are always on. With an audio device connected with HDMI CEC, you can use one of the EasyLink settings.

- If you select **EasyLink**, the TV sends the TV sound to the audio device. The TV will switch off the TV speakers when the device is playing the sound.

- If you select **EasyLink autostart**, the TV will switch on the audio device, send the TV sound to the device and switch off the TV speakers.

With **EasyLink** or **EasyLink autostart** selected, you can still switch to TV speakers or device speakers in the Picture and sound menu.

To set the TV speakers...

Consumer Mode: On – Not available in this mode.

Guest Mode: On – Guest Menu: Not available in Guest Menu.

(For professional mode information, please refer to Installation manual)

Clear sound

With **Clear Sound**, you improve the sound for speech. Ideal for news programmes.

You can switch the speech improvement on or off.

To switch on or off...

1. Consumer Mode: On – Press **▲ HOME**.
- Guest Mode: On – Guest Menu: Not available in Guest Menu.
- (For professional mode information, please refer to Installation manual)
2. Select **Setup > TV settings > Sound > Advanced > Clear Sound**.
3. Press **▶** (right) and select **On** or **Off**.
4. Press **↵**, repeatedly if necessary, to close the menu.

HDMI 1-ARC

If you do not need an Audio Return Channel (ARC) on any of the HDMI connections, you can switch the ARC signal off.

1. Consumer Mode: On – Press **▲ HOME**.
- Guest Mode: On – Guest Menu: Not available in Guest Menu.
- (For professional mode information, please refer to Installation manual)
2. Select **Setup > TV settings > Sound > Advanced > HDMI 1 - ARC**.
3. Press **▶** (right) and select **On** or **Off**.
4. Press **↵**, repeatedly if necessary, to close the menu.

Audio out format

With **Audio out format** you can set the audio out signal of the TV to fit the sound processing capabilities of your Home Theatre System.

To set **Audio out format**...

1. Consumer Mode: On – Press **▲ HOME**.
- Guest Mode: On – Guest Menu: Not available in Guest Menu.
- (For professional mode information, please refer to Installation manual)
2. Select **Setup > TV settings > Sound > Advanced > Audio out format**.
3. Press **▶** (right) and select **Multichannel** or **Stereo**.
4. Press **↵**, repeatedly if necessary, to close the menu.

Audio out levelling

With **Audio out levelling** you can level the sound volume of the Home Theatre System with the volume of the TV when you switch over from one to another.

To level the difference in volume...

1. Consumer Mode: On – Press **▲ HOME**.
- Guest Mode: On – Guest Menu: Not available in Guest Menu.
- (For professional mode information, please refer to Installation manual)
2. Select **Setup > TV settings > Sound > Advanced > Audio out levelling**.
3. Select **More**, **Medium**, or **Less**, then press **OK**.
4. If the volume difference is large, select **More**. If the volume difference is small, select **Less**.
5. Press **↵**, repeatedly if necessary, to close the menu.

Audio out delay

If you set an Audio sync delay on your Home Theatre System, to synchronise the sound with the picture, you must switch off **Audio out delay** on the TV.

To switch off **Audio out delay**...

1. Consumer Mode: On – Press **HOME**.
Guest Mode: On – Guest Menu: Not available in Guest Menu.
(For professional mode information, please refer to Installation manual)
2. Select **Setup > TV settings > Sound > Advanced > Audio out delay**.
3. Press **▶** (right) and select **Off** or **On**.
4. Press **↵**, repeatedly if necessary, to close the menu.

Audio out offset

If you cannot set a delay on the Home Theatre System, you can set a delay on the TV with **Audio out offset**.

To synchronise the sound on the TV...

1. Consumer Mode: On – Press **HOME**.
Guest Mode: On – Guest Menu: Not available in Guest Menu.
(For professional mode information, please refer to Installation manual)
2. Select **Setup > TV settings > Sound > Advanced > Audio out offset**.
3. Use the slider bar to set the sound offset and press **OK**.
4. Press **↵**, repeatedly if necessary, to close the menu.

11.3

General settings

Menu language

To change the language of the TV menus and messages...

1. Consumer Mode: On – Press **HOME**.
Guest Mode: On – Guest Menu: Not available in Guest Menu.
(For professional mode information, please refer to Installation manual)
2. Select **Setup > TV settings > Region and Language > Menu language**.
3. Select on the language you need.
4. Press **↵**, repeatedly if necessary, to close the menu.

Clock

Date and Time

Automatic

In some countries, digital broadcasts do not send UTC – Coordinated Universal Time information. The daylight saving change might be ignored and the TV might show an incorrect time.

When you record programmes – scheduled in the TV Guide, we recommend not to change the time and date manually. In some countries, for some network operators, the **Clock** setting is hidden to avoid an incorrect clock setting.

To correct the TV clock automatically...

1. Consumer Mode: On – Press **HOME**.
Guest Mode: On – Guest Menu: Not available in Guest Menu.
(For professional mode information, please refer to Installation manual)
2. Select **Setup > TV settings > General settings > Clock > Auto Clock Mode**, and select **Country dependent**.
3. Select **Daylight saving** and select the appropriate setting.
4. Press **↵**, repeatedly if necessary, to close the menu.

Manual

To set the TV clock manually...

1. Consumer Mode: On – Press **HOME**.
Guest Mode: On – Guest Menu: Not available in Guest Menu.
(For professional mode information, please refer to Installation manual)
2. Select **Setup > TV settings > General settings > Clock > Auto Clock Mode**, and select **Manual**.
3. Select **Date and Time** to adjust.
4. Press **↵**, repeatedly if necessary, to close the menu.

Time zone

To set the time zone...

1. Consumer Mode: On – Press **HOME**.
Guest Mode: On – Guest Menu: Not available in Guest Menu.
(For professional mode information, please refer to Installation manual)
2. Select **Setup > TV settings > General settings > Clock > Time zone**.
3. Select one of the time zones.
4. Press **↵**, repeatedly if necessary, to close the

menu.

Sleep timer

With the sleep timer, you can set the TV to switch to standby automatically after a preset time.

To set the sleep timer...

1. Consumer Mode: On – Press **▲ HOME**.
Guest Mode: On – Guest Menu: Not available in Guest Menu.
(For professional mode information, please refer to Installation manual)

2. Select **Setup > TV settings > General settings > Sleep timer**.

With the slider bar you can set the time to up to 180 minutes in increments of 5 minutes. If set to 0 minutes, the sleep timer is switched off. You can always switch off your TV earlier or reset the time during the countdown.

3. Press **↵**, repeatedly if necessary, to close the menu.

Switch off timer

If the TV receives a TV signal but you don't press a key on the remote control during a 4 hour period, the TV switches off automatically to save energy. Also, if the TV does not receive a TV signal nor a remote control command for 10 minutes, the TV switches off automatically.

If you use the TV as a monitor or use a digital receiver to watch TV (a Set-Top Box - STB) and you do not use the remote control of the TV, you should deactivate this automatic switch off.

To deactivate the Switch off timer...

1. Consumer Mode: On – Press **▲ HOME**.
Guest Mode: On – Guest Menu: Not available in Guest Menu.
(For professional mode information, please refer to Installation manual)

2. Select **Setup > TV settings > General settings > Switch off timer**.

3. Select inside the slider bar to adjust the value. The value 0 (Off) deactivates the automatic switch off.

4. Press **↵**, repeatedly if necessary, to close the menu.

Location

To set the TV for Home use...

1. Consumer Mode: On – Press **▲ HOME**.
Guest Mode: On – Guest Menu: Not available in Guest Menu.
(For professional mode information, please refer to Installation manual)

2. Select **Setup > TV settings > General settings > Location** and press **OK**.

3. Select **Home** and press **OK**.

4. Press **↵**, repeatedly if necessary, to close the menu.

TV placement

As part of the first installation, this setting is set to either **On a TV stand** or **On the Wall**. If you have changed the placement of the TV since then, adjust this setting accordingly for best sound reproduction.

1. Consumer Mode: On – Press **▲ HOME**.
Guest Mode: On – Guest Menu: Not available in Guest Menu.
(For professional mode information, please refer to Installation manual)

2. Select **Setup > TV settings > General settings > TV Placement** and press **OK**.

3. Select **On a TV stand** or **On the Wall**.

4. Press **↵**, repeatedly if necessary, to close the menu.

Factory settings

You can set the TV back to the original TV settings (the factory settings).

To switch back to the original settings...

1. Consumer Mode: On – Press **▲ HOME**.
Guest Mode: On – Guest Menu: Not available in Guest Menu.
(For professional mode information, please refer to Installation manual)

2. Select **Setup > TV settings > General settings > Factory Settings** and press **OK**.

3. Press **↵**, repeatedly if necessary, to close the menu.

Reinstall TV

You can redo a full TV installation. The TV is completely reinstalled.

To redo a full TV installation...

1. Consumer Mode: On – Press **▲ HOME**.
Guest Mode: On – Guest Menu: Not available in Guest Menu.
(For professional mode information, please refer to Installation manual)
2. Select **Setup > TV settings > General settings > Reinstall TV** and press **OK**.
3. Follow the instructions on screen. The installation may take a few minutes.

Specifications

12.1

Environmental

Saving energy

The **Eco settings** bundle the settings that help the environment.

While you are watching TV channels, press **■** to open **Eco settings**.

Press **■** again to close **Eco settings**.

Energy saving

This Picture style sets the picture, in the most ideal energy conscious setting.

Screen off

If you only listen to music, you can switch off the TV screen to save energy.

Select **Screen off** and press **OK**. To switch the screen back on, press any key on the remote control.

Auto switch off

If you do not press a key on the remote control during a 4 hour period, or if the TV receives no signal for 10 minutes, the TV switches off automatically to save energy.

If you use the TV as a monitor or use a digital receiver to watch TV (a Set-top box - STB) and you do not use the remote control of the TV, deactivate the automatic switch off.

In addition to the **Eco settings**, your TV also has environmentally friendly technology with regard to power consumption.

Inactive devices off

Switch off connected EasyLink HDMI-CEC (Consumer Electronic Control) compliant devices that are inactive.

European energy label

The **European Energy Label** informs you on the energy efficiency class of this product. The greener the energy efficiency class of this product is, the lower the energy it consumes.

On the label, you can find the energy efficiency class, the average power consumption of this product in use and the average energy consumption for 1 year. You can also find the power consumption values for this product on the Philips website for your country at www.philips.com/TV

Product Fiche

24HFL3011

- Energy Efficiency Class : A+
- Visible Screen Size : 60 cm / 24 inch
- On Mode Power Consumption (W) : 21 W
- Annual Energy Consumption (kWh) * : 31 kWh
- Standby Power Consumption (W) **: 0.30 W
- Display Resolution (Pixels) : 1366 x 768p

32HFL3011

- Energy Efficiency Class : A+
- Visible Screen Size : 80 cm / 32 inch
- On Mode Power Consumption (W) : 31 W
- Annual Energy Consumption (kWh) * : 45 kWh
- Standby Power Consumption (W) **: 0.30 W
- Display Resolution (Pixels) : 1366 x 768p

40HFL3011

- Energy Efficiency Class : A+
- Visible Screen Size : 102 cm / 40 inch
- On Mode Power Consumption (W) : 46 W
- Annual Energy Consumption (kWh) * : 68 kWh
- Standby Power Consumption (W) **: 0.30 W
- Display Resolution (Pixels) : 1920 x 1080p

* Energy consumption kWh per year, based on the power consumption of the television operating 4 hours per day for 365 days. The actual energy consumption depends on how the television is used.

** When the TV is turned off with the remote control and no function is active.

End of use

Disposal of your old product and batteries

Your product is designed and manufactured with high quality materials and components, which can be recycled and reused.



When this crossed-out wheeled bin symbol is attached to a product it means that the product is covered by the European Directive 2002/96/EC.



Disposal of Waste Equipment by Users in Private Household in the European Union.

This symbol on the product or on its packaging indicates that this product must not be disposed

of with your other household waste. Instead, it is your responsibility to dispose of your waste equipment by handing it over to a designated collection point for the recycling of waste electrical and electronic equipment. The separate collection and recycling of your waste equipment at the time of disposal will help to conserve natural resources and ensure that it is recycled in a manner that protects human health and the environment. For more information about where you can drop off your waste equipment for recycling, please contact your local city office, your household waste disposal service or the shop where you purchased the product.

Please inform yourself about the local separate collection system for electrical and electronic products.

Please act according to your local rules and do not dispose of your old products with your normal household waste. Correct disposal of your old product helps to prevent potential negative consequences for the environment and human health.

Your product contains batteries covered by the European Directive 2006/66/EC, which cannot be disposed with normal household waste.



Please find out for yourself about the local rules on separate collection of batteries because correct disposal will help to prevent negative consequences for the environment and human health.

12.2

Reception

- Aerial input : 75 ohm coaxial (IEC75)
- Tuner bands : Hyperband; S-Channel; UHF; VHF
- DVB : DVB-T (terrestrial, antenna) COFDM 2K/8K; DVB-T2; DVB-C (cable) QAM
- Analogue video playback : NTSC; SECAM; PAL
- Digital video playback : MPEG2 SD/HD (ISO/IEC 13818-2); MPEG4 SD/HD (ISO/IEC 14496-10)
- Digital audio playback (ISO/IEC 13818-3)

12.3

Display

Type

Diagonal screen size:

- 24HFL3011: 60 cm / 24 inch
- 32HFL3011: 80 cm / 32 inch
- 40HFL3011: 102 cm / 40 inch

Display resolution:

- 1366 x 768p (for 24HFL3011/32HFL3011)
- 1920 x 1080p (for 40HFL3011)

Display resolutions

Video formats

Resolution — Refresh rate

- 480i - 60 Hz
- 480p - 60 Hz
- 576i - 50 Hz
- 576p - 50 Hz
- 720p - 50 Hz, 60 Hz
- 1080i - 50 Hz, 60 Hz
- 1080p - 24 Hz, 25 Hz, 30 Hz

Computer formats

Resolutions (amongst others)

- 640 x 480p - 60 Hz
- 800 x 600p - 60 Hz
- 1024 x 768p - 60 Hz
- 1280 x 768p - 60 Hz
- 1360 x 765p - 60 Hz
- 1360 x 768p - 60 Hz
- 1280 x 1024p - 60 Hz
- 1920 x 1080p - 60 Hz

12.4

Power

Product specifications are subject to change without notice. For more specification details of this product, see www.philips.com/support

Power

- Mains power : AC 220-240V +/-10%
- Ambient temperature : 5°C to 35°C
- Standby power consumption : less than 0.3W
- Power saving features : Eco mode, Picture mute (for radio), Auto switch-off, Eco settings menu.

The power rating stated on the product typeplate is the power consumption for this product during normal household use (IEC 62087 Ed.2). The maximum power rating, stated between brackets, is

used for electrical safety (IEC 60065 Ed. 7.2).

12.5

Dimensions and weights

24HFL3011

- without TV stand:
Width 559.6 mm - Height 335.8 mm - Depth 44.9 mm
- Weight ± 3.29 kg

- with TV stand:
Width 559.6 mm - Height 344.5 mm - Depth 112 mm -
Weight ± 3.32 kg

32HFL3011

- without TV stand:
Width 726.5 mm - Height 425.4 mm - Depth 76.8 mm
- Weight ± 4.88 kg

- with TV stand:
Width 726.5 mm - Height 490.9 mm - Depth 186 mm
- Weight ± 4.96 kg

40HFL3011

- without TV stand:
Width 918 mm - Height 531.5 mm - Depth 76.8 mm -
Weight ± 8.0 kg

- with TV stand:
Width 918 mm - Height 596.7 mm - Depth 221.9 mm -
Weight ± 9.98 kg

12.6

Connectivity

TV Rear

- HDMI 1 in - ARC - HDCP 2.2
- HDMI 2 in - HDCP 2.2
- SERV. U: Service port
- AUDIO IN (DVI): Stereo 3.5mm mini-jack
- DIGITAL AUDIO OUT: SPDIF
- YPbPr : Y Pb Pr, Audio L/R : Stereo mini-jack 3.5mm
- USB
- TV ANTENNA: 75 ohm coaxial (IEC)

TV Side

- CI: Common Interface
- HDMI 3 in - HDCP 2.2
- USB
- Headphones: Stereo 3.5mm mini-jack

12.7

Sound

- Mono / Stereo
- Sound enhancement : Incredible Surround, Clear Sound
- Output power:
24": 10W (RMS @ 10% THD)
32"/40": 16W (RMS @ 10% THD)

12.8

Multimedia

Note: Multimedia file names must not exceed 128 characters.

Supported multimedia connections

- USB (FAT / FAT 32 / NTFS): only connect USB devices that consume 500 mA of power or less.

Supported image files

- JPEG: *.jpg, *.jpeg
- PNG: *.png,*.jpg,*.jpeg

Supported audio files

- MPEG1: *.mp3

Supported video files

- *.avi, *.mp4, *.mov, *.mkv, *.mpg, *.mpeg

Supported subtitle format

- SRT: multiple language support

Software

13.1

Software version

To view the current TV software version...

1. Consumer Mode: On – Press **▲ HOME**.
Guest Mode: On – Guest Menu: Not available in Guest Menu.
(For professional mode information, please refer to Installation manual)
2. Select **Setup > Software settings** and press **OK** to view current software information.
3. Press **↵**, repeatedly if necessary, to close the menu.

13.2

Open source software

This television contains open source software. TP Vision Europe B.V. hereby offers to deliver, upon request, a copy of the complete corresponding source code for the copyrighted open source software packages used in this product for which such offer is requested by the respective licences.

This offer is valid up to three years after product purchase to anyone in receipt of this information. To obtain the source code, please write in English to .

open.source@tpvision.com

13.3

Open source license

Open source license

Open source license statement

Acknowledgements and License Texts for any open source software used in this product. This is a document describing the distribution of the source code used in this product, which fall either under the GNU General Public License (the GPL), or the GNU Lesser General Public License (the LGPL), or any other open source license. Instructions to obtain source code for this software can be found in the documentation supplied with this product.

TP VISION MAKES NO WARRANTIES WHATSOEVER, EITHER EXPRESS OR IMPLIED, INCLUDING

ANY WARRANTIES OF MERCHANTABILITY OR FITNESS FOR A PARTICULAR PURPOSE, REGARDING THIS SOFTWARE.

TP Vision offers no support for this software. The preceding does not affect your warranties and statutory rights regarding any product(s) you purchased. It only applies to this source code made available to you.

libsqlite3

SQLite is a C library that implements an SQL database engine.

Programs that link with the SQLite library can have SQL database access without running a separate RDBMS process.

Source: <http://linuxappfinder.com/package/libsqlite3-0>

libpng

It supports almost all PNG features, is extensible, and has been extensively tested for over 17 years

Source: <http://www.libpng.org>

libboost

Provides a repository for free peer-reviewed portable C++ source libraries. The emphasis is on libraries which work well with the C++ standard library

Source: <http://www.boost.org>

libjpeg (6b)

Libjpeg is a widely used C library for reading and writing JPEG image files.

Source: <http://libjpeg.sourceforge.net/>

zlib

zlib is designed to be a free, general-purpose, legally unencumbered -- that is, not covered by any patents -- lossless data-compression library for use on virtually any computer hardware and operating system.

Source: www.zlib.net

DirectFB

DirectFB is a thin library that provides hardware graphics acceleration, input device handling and abstraction, integrated windowing system with support for translucent windows and multiple display layers, not only on top of the Linux Framebuffer Device.

Source: <https://github.com/DirectFB>

FFmpeg (0.6)

Cross-platform solution to record, convert and stream audio and video. It includes libavcodec - the leading audio/video codec library

Source: <http://www.ffmpeg.org>

Log4c

Log4c is a library of C for flexible logging to files, syslog and other destinations. It is modeled after the Log for Java library, staying as close to their API as is reasonable. Here is a short introduction to Log4j which describes the API, and design rationale.

Source: <http://log4c.sourceforge.net>

libmtd

MTD development is kept in GIT and managed according to standard Linux development practices.

Source: <http://www.linux-mtd.infradead.org>

iconv

This library provides an iconv() implementation, for use on systems which don't have one, or whose implementation cannot convert from/to Unicode.

Source: <https://github.com/GerHobbelt/libiconv>

libcurl

libcurl is a free and easy-to-use client-side URL transfer library, supporting DICT, FILE, FTP, FTPS, Gopher, HTTP, HTTPS, IMAP, IMAPS, LDAP, LDAPS, POP3, POP3S, RTMP, RTSP, SCP, SFTP, SMTP, SMTPS, Telnet and TFTP.

Source: <https://curl.haxx.se/libcurl/>

libexif

the EXIF parsing library. exif, the simple command line interface to libexif. ... as libexif source tarball releases

Source: <http://libexif.sourceforge.net>

openssl

OpenSSL is an open source project that provides a robust, commercial-grade, and full-featured toolkit for the Transport Layer Security (TLS) and Secure Sockets Layer (SSL) protocols. It is also a general purpose cryptography library.

Source: <https://www.openssl.org>

uchardet

An encoding detector library ported from Mozilla

Source: <https://github.com/BYVoid/uchardet>

webkit

WebKit is the web browser engine used by Safari, App Store, and many other OS X, iOS, and Linux applications.

Source: <https://webkit.org>

Troubleshooting and support

Troubleshooting

Channels

No digital channels found during the installation

See the technical specifications to make sure that your TV supports DVB-T or DVB-C in your country. Make sure that all cables are properly connected and that the correct network is selected.

Previously installed channels are not in the channel list

Make sure that the correct channel list is selected.

General

The TV does not switch on

- Disconnect the power cable from the power outlet. Wait for one minute then reconnect it.
- Make sure that the power cable is securely connected.

Creaking sound at startup or switch off

When you are turning the TV on, off or to standby, you hear a creaking sound from the TV chassis. The creaking sound is due to the normal expansion and contraction of the TV as it cools and warms up. This does not affect performance.

TV does not respond to the remote control

The TV requires some time to start up. During this time, the TV does not respond to the remote control or TV controls. This is normal behaviour. If the TV continues to be unresponsive to the remote control, you can check if the remote control is working by means of a mobile phone camera. Put the phone in camera mode and point the remote control to the camera lens. If you press any key on the remote control and you notice the infra red LED flicker through the camera, the remote control is working. The TV needs to be checked. If you do not notice the flickering, the remote control might be broken or its batteries are low. This method of checking the remote control is not possible with remote controls which are wirelessly paired with the TV.

The TV goes back to standby after showing the Philips startup screen

When the TV is in standby, a Philips startup screen is displayed, then the TV returns to standby mode. This is normal behaviour. When the TV is disconnected and reconnected to the power supply, the startup screen is displayed at the next startup. To switch on the TV from standby, press on the remote control or the TV.

The standby light keeps on blinking

Disconnect the power cable from the power outlet. Wait 5 minutes before you reconnect the power cable. If the blinking reoccurs, contact Philips TV Consumer Care.

Wrong menu language

Change the language back to your language.

1. Consumer Mode: On – Press **↑ HOME**.
Guest Mode: On – Guest Menu: Not available in Guest Menu.
(For professional mode information, please refer to Installation manual)
2. Select **Setup > TV settings > Region and Language > Menu language** and press **OK**.
3. Select the language you want and press **OK**.
4. Press **↵**, repeatedly if necessary, to close the menu.

Picture

No picture / distorted picture

- Make sure that the antenna is properly connected to the TV.
- Make sure that the correct device is selected as the display source.
- Make sure that the external device or source is properly connected.

Sound but no picture

- Make sure that the picture settings are set correctly.

Poor antenna reception

- Make sure that the antenna is properly connected to the TV.
- Loud speakers, unearthed audio devices, neon lights, high buildings and other large objects can influence reception quality. If possible, try to improve the reception quality by changing the antenna direction or moving devices away from the TV.
- If reception on only one channel is poor, fine-tune this channel.

Poor picture from a device

- Make sure that the device is connected properly.
- Make sure that the picture settings are set correctly.

Picture settings change after a while

Make sure that **Location** is set to **Home**. You can change and save settings in this mode.

A commercial banner appears

Make sure that **Location** is set to **Home**.

Picture does not fit the screen

Change to a different picture format.

Press **⚙️ SETTINGS** key on remote control to access the quick settings, then select **Picture format** for adjustments.

Picture format keeps changing with different channels

Select a non 'Auto' picture format.

Picture position is incorrect

Picture signals from some devices may not fit the screen correctly. Check the signal output of the connected device.

Computer picture is not stable

Make sure that your PC uses the supported resolution and refresh rate.

Sound

No sound or poor sound quality

If no audio signal is detected, the TV automatically switches the audio output off — this does not indicate malfunction.

- Make sure that the sound settings are correctly set.
- Make sure that all cables are properly connected.
- Make sure that the volume is not muted or set to zero.
- Make sure that the TV audio output is connected to the audio input on the Home Theatre System.
- Sound should be heard from the HTS speakers.
- Some devices may require you to manually enable HDMI audio output. If HDMI audio is already enabled, but you still do not hear audio, try changing the digital audio format of the device to PCM (Pulse Code Modulation). Refer to the documentation accompanying your device for instructions.

Connections

HDMI

- Note that HDCP (High-bandwidth Digital Content Protection) support can delay the time taken for a TV to display content from an HDMI device.
- If the TV does not recognise the HDMI device and no picture is displayed, switch the source from one device to another and back again.
- If there are intermittent sound disruptions, make sure that output settings from the HDMI device

are correct.

- If you use an HDMI-to-DVI adapter or HDMI-to-DVI cable, make sure that an additional audio cable is connected to AUDIO IN (mini-jack only), if available.

EasyLink does not work

- Make sure that your HDMI devices are HDMI-CEC compatible. EasyLink features only work with devices that are HDMI-CEC compatible.

No volume icon shown

- When a HDMI-CEC audio device is connected this behaviour is normal.

Photos, videos and music from a USB device do not show

- Make sure that the USB storage device is set to Mass Storage Class compliant, as described in the storage device's documentation.
- Make sure that the USB storage device is compatible with the TV.
- Make sure that the audio and picture file formats are supported by the TV.

Choppy playback of USB files

- The transfer performance of the USB storage device may limit the data transfer rate to the TV which causes poor playback.

14.2

Register

Register your TV and enjoy a range of benefits including full support (including downloads), privileged access to information about new products, exclusive offers and discounts, the chance to win prizes and even participate in special surveys about new releases.

Go to www.philips.com/welcome

14.3

Online help

To solve any Philips TV related problem, you can consult our online support. You can select your language and enter your product model number.

Go to www.philips.com/support .

On the support site you can find your country's telephone number to contact us as well as answers to frequently asked questions (FAQs). In some countries, you can chat with one of our collaborators and ask your question directly or send a question by email. You can download new TV software or the manual to read on your computer.

Consumer Care / Repair

For support and repair, call the Consumer Care hotline in your country.

Find the telephone number in the printed documentation that came with the TV.
Or consult our website www.philips.com/support.

TV model number and serial number

You might be asked to provide the TV product model number and serial number. Find these numbers on the packaging label or on the type label on the back or bottom of the TV.

Warning

Do not attempt to repair the TV yourself. This may cause severe injury, irreparable damage to your TV or void your warranty.

Safety and care

15.1

Safety

Important

Read and understand all safety instructions before you use the TV. If damage is caused by failure to follow instructions, the warranty does not apply.

Secure the TV from falling over

Always use the supplied wall bracket to secure the TV from falling over. Mount the bracket and secure the TV onto the bracket, even if you put the TV on the floor.

You can find the mounting instructions in the Quick Start Guide that came with the TV. In case you lost this guide, you can download the guide from www.philips.com. Use the product type number of the TV to look for the Quick Start Guide to download.

Risk of electric shock or fire

- Never expose the TV to rain or water. Never place liquid containers, such as vases, near the TV. If liquids are spilt on or into the TV, disconnect the TV from the power outlet immediately. Contact Philips TV Consumer Care to have the TV checked before use.
- Never expose the TV, remote control or batteries to excessive heat. Never place them near burning candles, naked flames or other heat sources, including direct sunlight.
- Never insert objects into the ventilation slots or other openings on the TV.
- Never place heavy objects on the power cord.
- Avoid force coming onto power plugs. Loose power plugs can cause arcing or fire. Ensure that no strain is exerted on the power cord when you swivel the TV screen.
- To disconnect the TV from the mains power, the power plug of the TV must be disconnected. When disconnecting the power, always pull the power plug, never the cord. Ensure that you have full access to the power plug, power cord and outlet socket at all times.

Risk of injury or damage to the TV

- Two people are required to lift and carry a TV that weighs more than 25 kg or 55 lbs.
- If you mount the TV on a stand, only use the supplied stand. Secure the stand to the TV tightly. Place the TV on a flat, level surface that can support the weight of the TV and the stand.
- When wall mounted, ensure that the wall mount can safely bear the weight of the TV set. TP Vision bears no responsibility for improper wall mounting that results in accident, injury or damage.
- Parts of this product are made of glass. Handle with care to avoid injury or damage.

Risk of damage to the TV !

Before you connect the TV to the power outlet, ensure that the power voltage matches the value printed on the back of the TV. Never connect the TV to the power outlet if the voltage is different.

Risk of injury

Follow these precautions to prevent the TV from toppling over and causing injury:

- Never place the TV on a surface covered by a cloth or other material that can be pulled away.
- Ensure that no part of the TV hangs over the edge of the mounting surface.
- Never place the TV on tall furniture, such as a bookcase, without anchoring both the furniture and TV to the wall or a suitable support.
- Teach children about the dangers of climbing on furniture to reach the TV.

Risk of swallowing batteries !

The remote control may contain coin-type batteries which can easily be swallowed by small children. Keep these batteries out of reach of children at all times.

Risk of overheating

Never install the TV in a confined space. Always leave a space of at least 10 cm or 4 inches around the TV for ventilation. Ensure curtains or other objects never cover the ventilation slots on the TV.

Lightning storms

Disconnect the TV from the power outlet and antenna before lightning storms.

During lightning storms, never touch any part of the TV, power cord or antenna cable.

Risk of hearing damage

Avoid using earphones or headphones at high volumes or for prolonged periods of time.

Low temperatures

If the TV is transported in temperatures below 5°C or 41°F, unpack the TV and wait until the TV temperature reaches room temperature before connecting the TV to the power outlet.

Humidity

In rare occasions, depending on temperature and humidity, minor condensation can occur on the inside of the TV glass front (on some models). To prevent this, do not expose the TV to direct sunlight, heat or extreme humidity. If condensation occurs, it will disappear spontaneously while the TV is playing for a few hours.

The condensation moisture will not harm the TV or cause malfunction.

15.2

Screen care

- Never touch, push, rub or strike the screen with any object.
- Unplug the TV before cleaning.
- Clean the TV and frame with a soft damp cloth and wipe gently. Never use substances such as alcohol, chemicals or household cleaners on the TV.
- To avoid deformations and colour fading, wipe off water drops as quickly as possible.
- Avoid stationary images as much as possible.

Stationary images are images that remain onscreen for extended periods of time. Stationary images include onscreen menus, black bars, time displays, etc. If you must use stationary images, reduce screen contrast and brightness to avoid screen damage.

Terms of Use

16.1

Terms of Use – TV

2016 © TP Vision Europe B.V. All rights reserved.

This product was brought to the market by TP Vision Europe B.V. or one of its affiliates, hereinafter referred to as TP Vision, which is the manufacturer of the product. TP Vision is the warrantor in relation to the TV with which this booklet was packaged. Philips and the Philips Shield Emblem are registered trademarks of Koninklijke Philips N.V.

Specifications are subject to change without notice. Trademarks are the property of Koninklijke Philips N.V or their respective owners. TP Vision reserves the right to change products at any time without being obliged to adjust earlier supplies accordingly.

The written material packaged with the TV and the manual stored in the memory of the TV or downloaded from the Philips website www.philips.com/support are believed to be adequate for the intended use of the system.

The material in this manual is believed adequate for the intended use of the system. If the product, or its individual modules or procedures, are used for purposes other than those specified herein, confirmation of their validity and suitability must be obtained. TP Vision warrants that the material itself does not infringe any United States patents. No further warranty is expressed or implied. TP Vision cannot be held responsible neither for any errors in the content of this document nor for any problems as a result of the content in this document. Errors reported to Philips will be adapted and published on the Philips support website as soon as possible.

Terms of warranty – Risk of injury, damage to TV or void of warranty!

Never attempt to repair the TV yourself. Use the TV and accessories only as intended by the manufacturer. The caution sign printed on the back of the TV indicates risk of electric shock. Never remove the TV cover. Always contact Philips TV Customer Care for service or repairs. Find the telephone number in the printed documentation that came with the TV. Or consult our website www.philips.com/support and select your country if needed. Any operation expressly prohibited in this manual, or any adjustments and assembly procedures not recommended or authorised in this manual, shall void the warranty.

Pixel characteristics

This LCD/LED product has a high number of colour pixels. Although it has effective pixels of 99.999% or

more, black dots or bright points of light (red, green or blue) may appear constantly on the screen. This is a structural property of the display (within common industry standards) and is not a malfunction.

CE compliance

Hereby, TP Vision Europe B.V. declares that this television is in compliance with the essential requirements and other relevant provisions of Directives 1999/5/EC (RTTE), 2004/108/EC (EMC), 2006/95/EC (Low Voltage), 2009/125/EC (Energy Labelling) and 2011/65/EC (RoHS). From June 2016 onwards the following Directives are valid 2014/53/EU (RED), 2009/125/EC (Eco Design), 2010/30/EU (Energy Labelling) and 2011/65/EC (RoHS).

Compliance with EMF

TP Vision manufactures and sells many products targeted at consumers which, like any electronic apparatus, in general have the ability to emit and receive electromagnetic signals. One of TP Vision's leading business principles is to take all necessary health and safety measures for our products, to comply with all applicable legal requirements and to stay well within the Electro Magnetic Field (EMF) standards applicable at the time of producing the products.

TP Vision is committed to developing, producing and marketing products that cause no adverse health effects. TP Vision confirms that, as long as its products are handled properly for their intended use, they are safe to use according to scientific evidence available today. TP Vision plays an active role in the development of international EMF and safety standards, enabling TP Vision to anticipate further developments in standardisation for early integration in its products.

Türkiye Cumhuriyeti: EEE Yönetmeliğine Uygundur

16.2

Copyrights

HDMI

HDMI®

The terms HDMI and HDMI High-Definition Multimedia Interface, and the HDMI Logo are trademarks or registered trademarks of HDMI Licensing LLC in the United States and other countries.



Dolby

Dolby®

Manufactured under license from Dolby Laboratories. Dolby and the double-D symbol are trademarks of Dolby Laboratories.



MHEG software

The copyright in MHEG software (the Software) comprised in this television (this product) and included to enable you to use interactive television features is owned by S&T CLIENT SYSTEMS LIMITED (the Owner). You are permitted to use the Software only in conjunction with this product.

Kensington

(If applicable)



Kensington and Micro Saver are registered US trademarks of ACCO World Corporation with issued registrations and pending applications in other countries throughout the world.

Other trademarks

All other registered and unregistered trademarks are the property of their respective owners.

Index

A

Amplifier, audio system 33
Antenna connection, tips 5
Audio language 18
Audio Out - Optical 7
Audio to video sync 9
Auto volume levelling 33
Auto volume levelling 32

B

Backlight contrast 28
Bass 32
Blu-ray Disc, connect 10
Brightness 30

C

CAM - Conditional Access Module 7
CAM, install 7
Channel, problems 42
Channel, switch 17
Channels, reinstall 21
CI+ 7
Clear Sound 33

C

clock 25

C

Colour 28
Colour, Colour enhancement 29
Colour, Colour temperature 29
Common Interface slot 7
Consumer Care 44
Contact Philips 44
Contrast 28
Contrast, Brightness 30
Contrast, Contrast modes 30
Contrast, Dynamic contrast 30
Contrast, Gamma 30
Contrast, Video contrast 30
CVBS 7

D

Digital Text 19
DVB (Digital Video Broadcast) 22
DVB, settings 22

E

EasyLink 6
EasyLink, connection 6
EasyLink, settings 6
Eco settings 37
End of use 37
European Energy Label 37

F

Format and edges, Picture format 31
Format and edges, Picture shift 31
Format and edges, Screen edges 31
Frequency scan 22

G

Game console, connect 10

Gamma 30

H

HDMI ARC 5
Headphones 12
Headphones volume 32
Hearing impaired 18
Home Theatre System, connect 8
Home Theatre System, multichannel 9
Home Theatre System, problems 10
Home Theatre System, volume levelling 9

I

Incredible surround 32

L

Language, audio 18
Location 35

M

MPEG artefact reduction 31

N

Network frequency 22
Noise reduction 31

O

On and Off 13
Online support 43
Open source software 40

P

Photos, slideshow 26
Picture style 28
Picture, backlight contrast 28
Picture, colour 28
Picture, problems 42
Picture, sharpness 29
Power connection 3
Programme, tune 23

R

Radio channel 17
Register your product 43
Repair 44

S

Safety instructions 45
Screen care 46
Screen off 37
Sharpness 29
Sharpness, MPEG artefact reduction 31
Sharpness, Noise reduction 31
Sleep timer 13
Sleep timer 25
Sound style 31
Sound, problems 43
Standby 13
Subtitles 17
Super resolution 30
Support, online 43
Surround mode 32
Switch off timer 25
Switch off timer 13

Switching on 13
Symbol rate 22
Symbol rate mode 22
Synchronise audio and video 9

T

Teletext 19
Terms of Use 47
Text 19
Treble 32
TV clock 25
TV guide, clock 25
TV placement 35
TV speakers 33

U

USB flash drive, connect 11

V

Videos, playback 26
Viewing distance 3

Y

Y Pb Pr, Audio 7



Contact information

Armenia

0-800-01-004

Austria/Österreich

0150 2842133

Belarus/Беларусь

8 10 800 2000 00 04

Belgium/België/Belgique

02 7007360

Bulgaria/България

0 0800 1154426

+359 2 4916273

Croatia/Hrvatska

0800 222 782

Czech Republic/Česká republika

800 142100

Denmark/Danmark

352 587 61

Estonia/Eesti Vabariik

800 0044 307

Finland/Suomi

09 229 019 08

France

01 57324070

Germany

0696 640 4383

Greece/Ελλάδα

0 0800 3122 1223

Greece Cyprus

800 92 256

Hungary/Magyarország

068 001 85 44

(06 1) 700 8151

Republic of Ireland/Poblacht na hÉireann

1 601 1161

Northern Ireland/Tuaisceart Éireann

1 601 1161

Italy/Italia

02 4528 7030

Kazakhstan/Қазақстан

8 10 800 1000 00 04

Latvia/Latvija

800 03 448

Lithuania/Lietuva

880 030 049

Luxembourg/Luxemburg

26 84 3000

Netherlands/Nederlands

010 4289533

Norway/Norge

22 70 82 50

Poland/Polska

022 349 1505

Portugal

0800 780 902

Romania/România

03 727 66905

031 6300042

Russia/Россия

8 (800) 220 0004

Serbia/Srbija

11 321 68 40

Slovakia/Slovensko

0800 0045 51

Slovenia

0800 80 255

Spain/España

915 909 335

Sweden/Sverige

08 6320 016

Switzerland/Schweiz/Suisse

223 102 116

Turkey/Türkiye

0 850 222 44 66

Ukraine/Україна

0 800 500 480

United Kingdom

020 7949 0069

This information is correct at the time of print. For updated information, see www.philips.com/support.



Specifications are subject to change without notice.
Trademarks are the property of Koninklijke Philips N.V. or their respective owners.
2016 © TP Vision Europe B.V. All rights reserved.
www.philips.com

