

Register your product and get support at
www.philips.com/welcome



49PUT7690/V7
43PUT7690/V7

EN User manual

PHILIPS



Contents

1	Notice	2
2	Important	3
	Product disposal Guidelines	4
3	Use your TV	5
4	Use more of your TV	10
5	Play picture, song and videos on USB storage devices	15
6	Smart TV	16
7	Troubleshooting	17
8	Product information	19
9	Consumer Guidelines	21
10	Warranty	22



1 Notice

Pixel characteristics

This LCD/LED product has a high number of color pixels. Although it has effective pixels of 99.999% or more, black dots or bright points of light (red, green or blue) may appear constantly on the screen. This is a structural property of the display (within common industry standards) and is not a malfunction.

Warranty

No components are user serviceable. Do not open or remove covers to the inside of the product. Repairs may only be done by Philips Service Centres and official repair shops. Failure to do so shall void any warranty, stated or implied.

Any operation expressly prohibited in this manual, or any adjustments and assembly procedures not recommended or authorised in this manual shall void the warranty.

2 Important

Read and understand all instructions before you use your TV. If damage is caused by failure to follow instructions, the warranty does not apply.

Safety

Risk of electric shock or fire!

- Never expose the TV to rain or water. Never place liquid containers, such as vases, near the TV. If liquids are spilt on or into the TV, disconnect the TV from the power outlet immediately. Contact Philips Consumer Care to have the TV checked before use.
- Never place the TV, remote control or batteries near naked flames or other heat sources, including direct sunlight. To prevent the spread of fire, keep candles or other flames away from the TV, remote control and batteries at all times.



- Never insert objects into the ventilation slots or other openings on the TV.
- When the TV is swivelled ensure that no strain is exerted on the power cord. Strain on the power cord can loosen connections and cause arcing.

Risk of short circuit or fire!

- Never expose the remote control or batteries to rain, water or excessive heat.
- Avoid force coming onto power plugs. Loose power plugs can cause arcing or fire.

Risk of injury or damage to the TV!

- Two people are required to lift and carry a TV that weighs more than 25 kg or 55 lbs.
- When stand mounting the TV, use only the supplied stand. Secure the stand to the TV tightly. Place the TV on a flat, level surface that can support the combined weight of the TV and the stand.
- When wall mounting the TV, use only a wall mount that can support the weight of the TV. Secure the wall mount to a wall that can support the combined weight of the TV and wall mount. PE Electronics Ltd. bears no responsibility for improper wall mounting that result in accident, injury or damage.

Risk of injury to children!

Follow these precautions to prevent the TV from toppling over and causing injury to children:

- Never place the TV on a surface covered by a cloth or other material that can be pulled away.
- Ensure that no part of the TV hangs over the edge of the surface.
- Never place the TV on tall furniture (such as a bookcase) without anchoring both the furniture and TV to the wall or a suitable support.
- Educate children about the dangers of climbing on furniture to reach the TV.

Risk of swallowing batteries!

- The product/remote control may contain a coin-type battery, which can be swallowed. Keep the battery out of reach of children at all times!

Risk of overheating!

- Never install the TV in a confined space. Always leave a space of at least 4 inches or 10 cm around the TV for ventilation. Ensure curtains or other objects never cover the ventilation slots on the TV.

Risk of damage to the TV!

- Before you connect the TV to the power outlet, ensure that the power voltage matches the value printed on the back of the TV. Never connect the TV to the power outlet if the voltage is different.

Risk of injury, fire or power cord damage!

- Never place the TV or any objects on the power cord.
- To easily disconnect the TV power cord from the power outlet, ensure that you have full access to the power cord at all times.
- When you disconnect the power cord, always pull the plug, never the cable.
- Disconnect the TV from the power outlet and antenna before lightning storms. During lightning storms, never touch any part of the TV, power cord or antenna cable.

Risk of hearing damage!

- Avoid using earphones or headphones at high volumes or for prolonged periods of time.

Low temperatures

- If the TV is transported in temperatures below 5°C or 41°F, unpack the TV and wait until the TV temperature matches room temperature before connecting the TV to the power outlet.

Screen care

- Avoid stationary images as much as possible. Stationary images are images that remain on-screen for extended periods of time. Examples include: on-screen menus, black bars and time displays. If you must use stationary images, reduce screen contrast and brightness to avoid screen damage.
- Unplug the TV before cleaning.
- Clean the TV and frame with a soft, damp cloth. Never use substances such as alcohol, chemicals or household cleaners on the TV.
- Risk of damage to the TV screen! Never touch, push, rub or strike the screen with any object.
- To avoid deformations and colour fading, wipe off water drops as soon as possible.

Product disposal Guidelines:



For the purpose of recycling to facilitate effective utilization of resources, please return this product to a nearby authorized collection center, registered dismantler, recycler, service center when disposing of this product.
In case of further assistance, you may contact nearest authorized service center.
Or Please see the Company website for further information on collection centers etc.
Visit-<http://www.philips.com>
Toll :1860 200 0129

संसाधनों का प्रभावी उपयोग सुगम बनाने हेतु पुनः चक्रण के प्रयोजन से इस उत्पाद को कृपया निकटवर्ती अधिकृत संग्रहण केंद्र, पंजीकृत भंडक या रिसाइकिलर (पुनः चक्रणकर्ता) को वापस करें।
अधिक जानकारी के लिए निकटवर्ती अधिकृत सर्विस सेंटर (सेवा केंद्र) से संपर्क करें।
या संग्रहण केंद्रों इत्यादि के बारे में अधिक जानकारी के लिए कृपया कंपनी की वेबसाइट देखें :-
Visit-<http://www.philips.com>
Toll :1860 200 0129



3 Use your TV

Congratulations on your purchase, and welcome to Philips. To fully benefit from the support that Philips offers, register your TV at www.philips.com/welcome.

3.1 Name and Function of Control on Set (49PUT7690/V7&43PUT7690/V7)

A) TV controls and Indicators

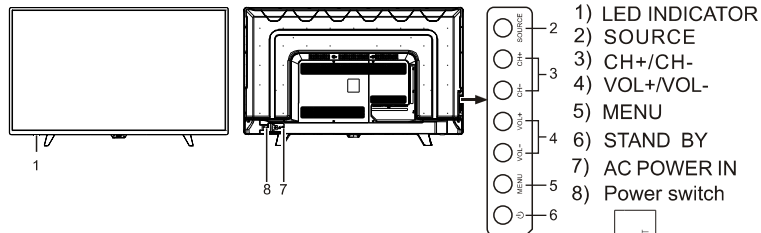

B) Connectivity

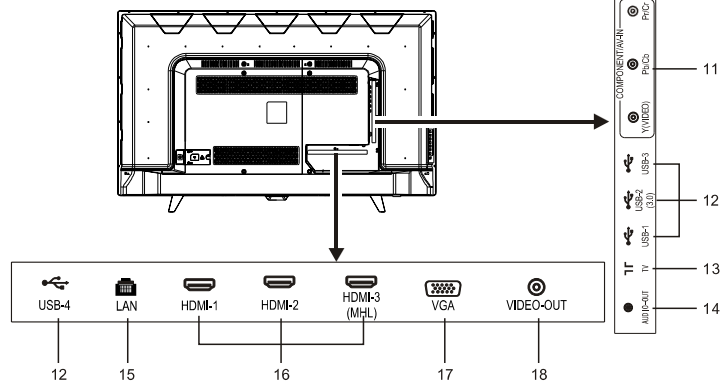

Note :

- 1) Above sketch and connectivity are just for representation. Actual product may look different.
- 2) For source selection by control on TV, press source key, select source by VOL+/VOL- key till you reach to desire source in source OSD and then press Source key.





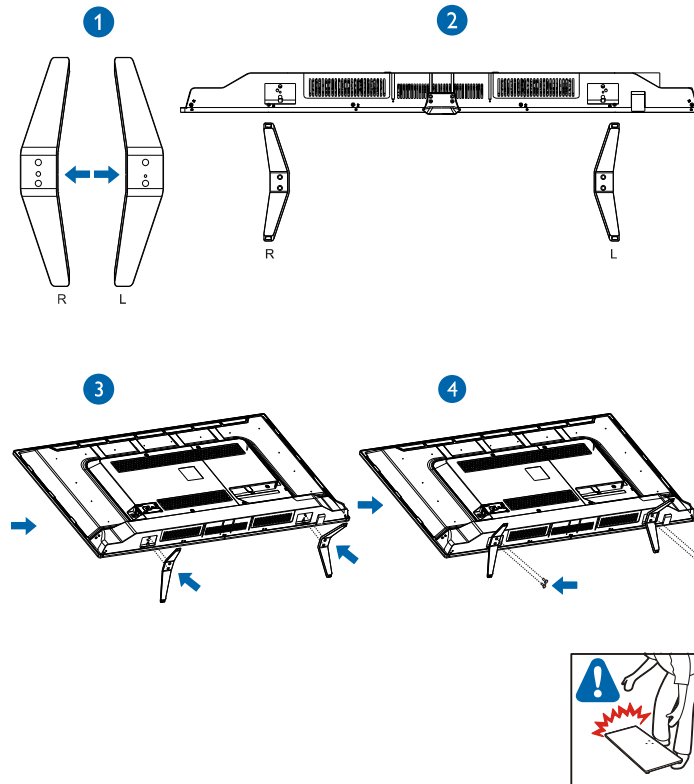



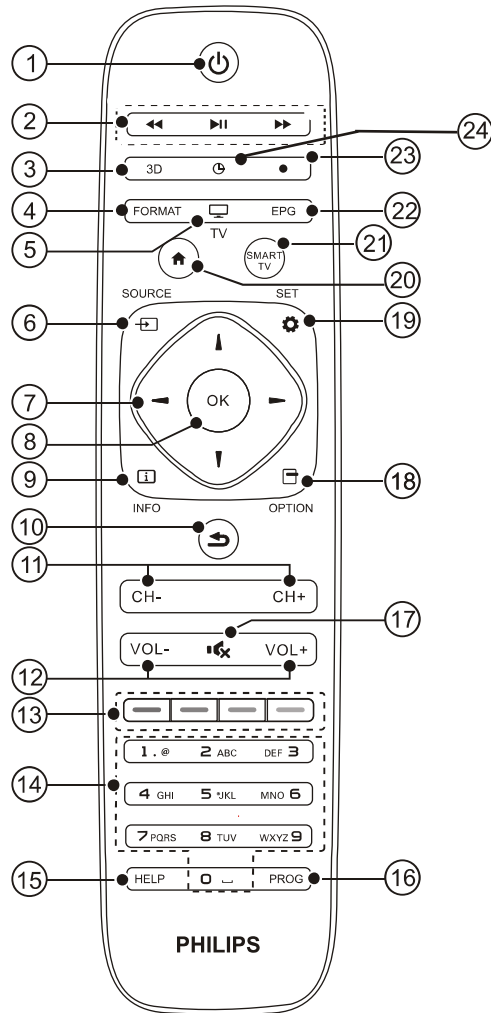



3.2 STAND INSTALLATION SHEET

- 1) Remove the TV unit from Box and polybag.
- 2) Place Polybag on flat surface with foam side facing up.
- 3) Place TV set on polybag with screw facing down.
- 4) Follow 1-4 sequence.



3.3 Name and Function of Control on Remote



- ①  (Standby-On)
 - Switches the TV ON or OFF. The TV is not powered off completely unless it is physically unplugged
- ② Multimedia Control buttons
 - Control video or music.
- ③ 3D
 - Not applicable for this series model's.
- ④ FORMAT
 - Adjust picture format.
- ⑤  TV
 - Access the TV mode.
- ⑥  SOURCE
 - Selects connected devices.
- ⑦  (Navigation buttons)
 - Navigate through menus and select items. (Also in USB mode).
- ⑧ OK
 - Confirm an entry or selection.
- ⑨  INFO
 - Displays the source information with details of input connected .
- ⑩ 
 - Return to the previous menu or exit a function.
 - Toggles between current& last viewed channel/ source.
- ⑪ CH - / CH +
 - Switch channels or Next/Prev. files
- ⑫ +/-
 - Adjust volume.
- ⑬ Color buttons
 - Select tasks or options.
 - Not Applicable for this series mode'sl
- ⑭ 0-9 Numeric buttons
 - Select channels.
- ⑮ HELP
 - Not applicable for this series model's.
- ⑯ PROG
 - Not applicable for this series model's.
- ⑰ 
 - Mute or restore audio.
- ⑱  OPTIONS
 - Access the option menu to adjust setting in USB Source.
- ⑲  (SET)
 - Access the setting menu.
- ⑳  (Home)
 - Access the home menu.
- ㉑  (SMART TV)
 - Access the Smart TV Home Page.
- ㉒ EPG
 - Not applicable for this series model's.
- ㉓  (RECORD)
 - Not applicable for this series model's.
- ㉔  (Sleep timer)
 - Control Sleep timer.

3.6 Remote control usage

When you use the remote control, hold it close to the TV and point it at the remote control sensor. Make sure that the line-of-sight between the remote control and TV is not blocked by furniture, walls or other objects.

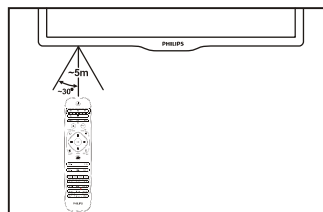

3.7 Battery Installation

1. Remove the battery compartment door.
2. Install 2 "AAA" or UM-4 (1.5V) batteries or equivalent with the correct polarity as indicated.
3. Refix the battery compartment door.

NOTE : Remove batteries when they are exhausted or if the remote control is not to be used for a long time.

BATTERY PRECAUTIONS :

Incorrect use of batteries can cause electrolyte leakage which will corrode the remote handset or cause the batteries to burst.

- Replace both batteries at the same time.
- Don't Mix battery types (alkaline with carb on, zinc etc.).
- Don't recharge.

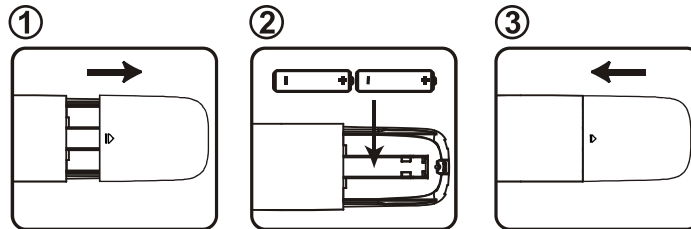

4 Use more of your TV

4.1 Main Menu

Menus help you to install channels, change picture and sound settings and access other TV features.

- 1 Press **▲**
» The menu screen appears.

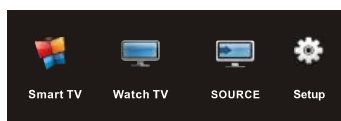

- 2 Select one of the following, then press OK
 - **[Smart TV]**: Access smart TV, you can surf the web, download apps with Play Store. In addition, you can enjoy photo, video, and music files stored on external storage devices (media center)
 - **[Watch TV]**: If a source other than antenna is selected, switch back to the antenna source.
 - **[Source]**: Access menus to change other source by pressing key.
 - **[Set up]**: Access menus to change picture, sound and other settings.

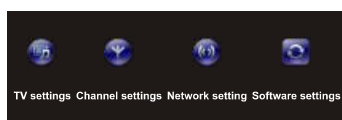

4.2 Manually adjust picture setting

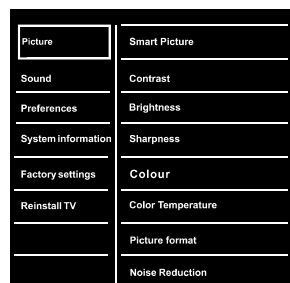

- 1 Press **⚙**
- 2 Select **[TV settings] > [Picture]**, then press OK.
- 3 Select one of the following settings, then Press **◀▶** to move, and press **▲▼** to adjust.
 - **[Smart picture]** : Access predefined smart picture settings.
 - **[Contrast]** : Adjust the intensity of backlight areas, while the video contents are kept unchanged.
 - **[Brightness]** : Adjust the intensity and details of dark areas.
 - **[Sharpness]** : Adjust sharpness in the image.
 - **[Colour]** : Adjust color saturation.
 - **[Color Temperature]** : Adjust the color balance in an image.
 - **[Picture format]** : Adjust the size in an Image, such as wide screen, 4:3, movie 16:9, subtitle zoom.
 - **[Noise Reduction]** : Filter and reduce noise in an Image

4.3 Use Smart Picture

Use smart picture to apply pre-defined picture settings.



- 1 Press 
- 2 Select **[TV Settings]> [Picture]>[Smart Picture]** then press OK.
- 3 Select one of the following settings, by▲▼
 - **[Standard]**: Adjust the picture's overall Effect.
 - **[Natural]**: Adjust the picture color shades.
 - **[Vivid]** : Rich and dynamic settings, ideal for daytime.
 - **[Personal]**: Apply your customised picture settings.

4.4 Use Picture Format

- 1 Press 
- 2 Select **[Picture Format]**, then press OK
- 3 Select any picture format, then press OK

Note

- Depending on the format of the picture source, some picture settings may not be available.

4.5 Manually adjust sound setting

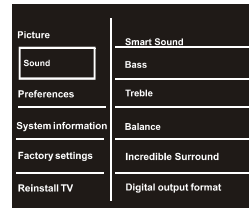

- 1 Press 
- 2 Select **[TV Settings]>[Sound]** then press OK.
- 3 Select one of the following settings, then Press ◀▶ to move, and press ▲▼ to adjust.
 - **[Smart Sound]** : Access predefined smart sound settings.
 - **[Bass]** : Adjust the bass level.
 - **[Treble]** : Adjust the treble level.
 - **[Balance]** : Adjust the balance of the right and left speakers.
 - **[Incredible Surround]** : Select on or off surround sound.
 - **[Digital out put format]** : Select digital out put format PCM / RAW

4.6 Use Smart Sound

Use smart sound to apply pre-defined Sound settings.



- 1 Press 
- 2 Select **[TV Settings]>[Sound]>[Smart Sound]** Then press OK.
- 3 Select one of the following settings, by **▲▼**
 - **[Smart sound]**: Access predefined smart sound settings.
 - **[Standard]**: Settings that suit most environments and types of audio.
 - **[News]** : Ideal settings for listening to news .
 - **[Cinema]**: Ideal settings for spoken audio, such as cinema.
 - **[Personal]**: Apply the settings that were customised in the sound menu.

4.7 Preferences

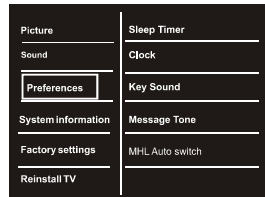

- 1 Press 
- 2 Select **[TV Settings]>[Preferences]** then press OK.
- 3 Select one of the following settings, then Press **◀▶** to move, and press **▲▼** to adjust.
 - **[Sleep Timer]**: Press **▲▼** adjust the Sleep time OFF and ON in step of 10~180 min.
 - **[Clock]**: Access or set Automatic /Manual clock
 - **[Key Sound]**: select ON or OFF to key sound.
 - **[Message Tone]**: select ON or OFF to easy link.
 - **[MHL Auto switch]**:select ON or OFF to MHL auto switch.

4.8 System information

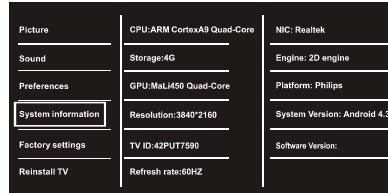

- 1 Select **[TV Settings]>[System information]** you can view the product system information.

4.9 Use PC

Use Geometric to automatically adjust phase and Clock for VGA mode

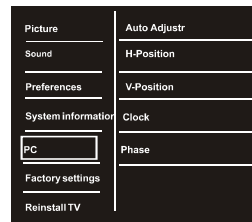



- 1 Press 
- 2 Select **[TV Settings]>[PC]** then press OK. This automatically adjust H & V-position, Phase and Clock for VGA mode

[PC]:

- **[Auto Setting]**:This automatically adjust H & V-position,Phase and Clock for VGA mode.
- **[H-Position]** : Adjust the horizontal position of image [Only in VGA].
- **[V-Position]**: Adjust the vertical position of image [Only in VGA].
- **[Clock]**: If picture is not OK with Auto Setting, then adjust by manual clock [Only in VGA].
- **[Phase]**: If picture is not OK with Auto Setting, then adjust by phase. [Only in VGA].

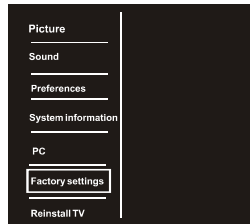
4.10 Factory Settings



- 1 Press 
- 2 Select **[TV Settings]>[Factory Settings]** then press OK.

Reset to factory default settings

4.11 Reinstall TV

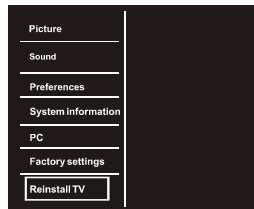

- 1 Press 
- 2 Select **[TV Settings]>[Reinstall TV]** then press OK.

Installation and resets the TV back to original settings



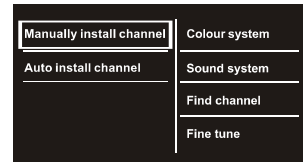

4.12 Channel settings

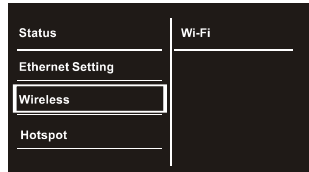

- 1 Press 
- 2 Select **[Channel Settings]**, then press OK.
 - **[Color system]**: Change the color system (AUTO/PAL/SECAM/NTSC) setting if the picture is not reproduced properly
Note: For India color system is Auto or PAL.
 - **[Find channel]**: Access particular channel,
 - **[Find tune]**: Press **▲▼** adjust from low or High frequency, until the best picture and sound.
 - **[Auto install channel]**: Select the function TV set will start auto tuning for all available channels.







4.13 Network settings

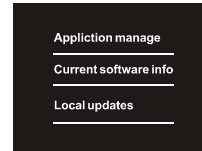

- 1 Press 
 - 2 Select **[Network Settings]** then press OK.
 - 3 Select one of the following settings , then press OK, Press     to adjust and change these options
- **[Status]:** You can view these information about network, Such as : Connect Format Net State
 - **[Ethernet Settings]:** Select IP address by Wired network through auto or manual selection.
 - **[Wireless]:** Access wireless network, the TV automatically display a list of available wireless networks.
Use a high-speed (broadband) connection to the Internet.
 - **[Hotspot (Wi-Fi)]:**
A Hotspot(Wi-Fi) is a wireless access point that provides internet access to network device.

4.14 Software settings



- 1 Press 
 - 2 Select **[Software settings]** then press OK
 - 3 Select one of the following settings, then press OK, press     to adjust the options.
- [Application manage]:**
- **Select settings :**
Press   to change the Default installation Location INTERNAL and EXTERNAL.
 - **All Applications:**
Access applications information.
 - **USB Device:**
Access USB Device storage space information.
- [Current Software info]:**
Access current software information.
- [Local updates]:**
Upgrade latest software trough USB.

5 Play picture, song and videos on USB storage devices

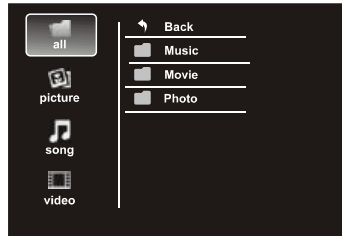

5.1 Connect a USB storage device to play pictures, song or videos stored on it.

- 1 Switch on the TV.
- 2 Connect the USB device to the USB port on the side of your TV
- 3 Press **SOURCE** key, then press OK.
- 4 Select **[Browse USB]**, then press OK.
The USB browser appears.

5.2 View Pictures

- 1 In the USB browser, select **[Picture]**, then press OK.
- 2 Select a photo or a photo album, then press OK to view the photo. To preview the next or previous photo, Press **◀▶** or use multimedia control buttons.

5.3 Listen to music

- 1 In the USB browser, select **[song]**, then press OK.
- 2 Press **▲▼** to move up/down music file then press OK
- 3 Press **◀▶** to play the previous or next music.

5.4 Watch video

- 1 In the USB browser, select **[video]**, then press OK.
- 2 Press **▲▼** to move up/down music file then press OK.
- 3 Press **◀▶** to play the previous or next music.

Note

Press following multimedia control buttons play of selected file

- **▶** to play.
- **⏸** to pause.
- **◀▶** To FF or FR.
- **CH+/CH-** to previous or next.
- **⏏** To view guide bar.

6 Smart TV



About Smart TV



Connect this PHILIPS UHD Smart TV to internet and discover a new world of television. You can make a wired connection to your router or you can link up wirelessly with Wi-Fi.

Setup Smart TV

The first time you open Smart TV, you need to configure your connection. If you do not want to set up Smart TV, press cancel/ skip.

Smart TV Apps

Open Smart TV

To open the Smart TV start page, Press . Alternatively, you can press , select **Smart TV** and press **OK**. Select one of the application, surf the web. Download apps with playstore, in addition you can enjoy photo, video and music files stored on external storage device.

Close Smart TV

To close the Smart TV start page, press  and select another activity.

Reset Smart TV

To reset your connection with Smart TV, you will clear your installed application and there logging permanently.

To clear / reset Smart TV

- 1 Press  and select Setup and press OK.
- 2 Select TV settings > Reinstall TV and press OK.

Note

- Philips bears no responsibility regarding the content and the quality of the content provided by the content service providers.
- To enjoy Smart TV Apps you must connect the TV to a router with a high-speed (broadband) connection to the Internet.

7 Troubleshooting

This section describes commonly encountered issues and accompanying solutions.

7.1 General TV issues

The TV does not switch on:

- Disconnect the power cable from the power outlet. Wait for one minute then reconnect it.
- Check that the power cable is securely connected.

The remote control is not working properly:

- Check that the remote control batteries are correctly inserted according to the +/- orientation.
- Replace the remote control batteries if they are flat or weak.
- Clean the remote control and TV sensor lens.

The standby light on the TV blinks red:

- Disconnect the power cable from the power outlet. Wait until the TV cools down before reconnecting the power cable. If the blinking reoccurs, contact Philips Consumer Care.

You forgot the code to unlock the TV lock feature

- Enter '8202'.

When turning the TV on/off/to standby, you hear a creaking sound from the TV chassis:

- No action is required. The creaking sound is normal expansion and contraction of the TV as it cools down and warms up. This does not impact performance.

7.2 TV channel issues

Previously installed channels do not appear in the channel list:

- Check that the correct channel list is selected.

7.3 Picture issues

The TV is on, but there is no picture:

- Check that the antenna is properly connected to the TV.
- Check that the correct device is selected as the TV source.

There is sound but no picture:

- Check that the picture settings are correctly set.

There is poor TV reception from an antenna connection:

- Check that the antenna is properly connected to the TV.
- Loudspeakers, unearthed audio devices, neon lights, high buildings and other large objects can influence reception quality. If possible, try to improve the reception quality by changing the antenna direction or moving devices away from the TV.
- If reception on only one channel is poor, fine tune this channel.

There is poor picture quality from connected devices:

- Check that the devices are connected properly.
- Check that the picture settings are correctly set.

The TV did not save your picture settings:

- Check that the TV location is set to the home setting. This mode offers you the flexibility to change and save settings.

The picture does not fit the screen; it is too big or too small:

- Try using a different picture format.

The picture position is incorrect:

- Picture signals from some devices may not fit the screen correctly. Check the signal output of the device.

7.4 Sound issues

There is a picture but sound quality is poor:

Note

- If no audio signal is detected, the TV automatically switches the audio output off this does not indicate malfunction.

- Check that all cables are properly connected.
- Check that the volume is not set to 0.
- Check that the sound is not muted.

There is a picture but the sound quality is poor:

- Check that the sound settings are correctly set.

There is a picture but sound comes from one speaker only:

- Verify that sound balance is set to the centre.

7.5 HDMI connection issues

There are problems with HDMI devices:

- Note that HDCP (High-bandwidth Digital Content Protection) support can delay the time taken for a TV to display content from a HDMI device.
- If the TV does not recognise the HDMI device and no picture is displayed, try switching the source from one device to another and back again.
- If there are intermittent sound disruptions, check that output settings from the HDMI device are correct.
- If you use an HDMI-to-DVI adapter or HDMI-to-DVI cable, check that an additional audio cable is connected to AV IN.

7.6 Computer connection issues

The computer display on the TV is not stable:

- Check that your PC uses the supported resolution and refresh rate.
- Select the "Auto Setting" function.
 1. Press **▲**
 2. Select **[Setup] > [Picture] > [Geometric] [Auto Setting]**.

7.7 Contact us

If you cannot resolve your problem, refer to the FAQs for this product at www.philips.com/support or Contact Customer Service Center.

Warning

- Do not attempt to repair the product yourself. This may cause severe injury, irreparable damage to your product or void your warranty.

Note

- Make a note of your TV model and serial number before you contact Philips. These numbers are printed on the back of the TV and on the packaging.

8 Product information

Product information is subject to change without notice. For detailed product information, go to www.philips.com/support.

8.1 Supported display resolutions

Computer formats (HDMI)

- Resolution - refresh rate:
 - 720 x 480p - 60Hz
 - 720 x 576p - 50Hz
 - 1280 x 720p - 50Hz,60Hz
 - 1920 x 1080p - 50Hz,60Hz
 - 1920 x 1080 I - 50Hz/60Hz
 - 3840 x 2160p - 50Hz/60Hz
 - 3840 x 2160 I - 50Hz/60Hz

Computer formats (VGA)

- Resolution - refresh rate:
 - 640 x 480 - 60Hz
 - 800 x 600 - 60Hz
 - 1024 x 768 - 60Hz
 - 1280 x 720 - 60Hz
 - 1360 x 768 - 60Hz
 - 1600 x 900 - 60Hz
 - 1920 x 1080 - 60Hz

8.2 Tuner/Reception/Transmission

- Antenna input: 75ohm coaxial (IEC75)
- TV system: PAL,B/G
- Video playback: NTSC, SECAM, PAL
- Tuner Bands: UHF, VHF

8.3 Remote control

- Type: RC
- Batteries: 2 x AAA (LR03 type)

8.4 Multimedia

- Supported USB storage device:
(Only FAT 16 or FAT 32 USB storage devices are supported)
- Supported storage file formats:
 - Images : JPEG, BMP, PNG
 - Audio : MP3.
 - Video :

File Extension	Container	Video Decoder
*.avi	AVI	MPEG 2/4 H.264
*.mp4 *.mov	MP4	MPEG 4 H.264
*.mkv	MKV	H.264

Note

- 1) USB file names must not exceed 128 characters.
- 2) The USB features/functions may vary from file to file depending on relative information present in the file

8.5 Power

- Mains power: AC 110-240V~ 50/60Hz
- Ambient temperature: 5 to 40 degrees Celsius
- Power consumption

49PUT7690/V7 :130W

43PUT7690/V7 :98W

8.6 TV mount

To wall mount the TV, kit is provided in accessory Bag along with TV set.

**Warning**

Follow all instructions provided with the TV mount. PE Electronics Ltd. bears no responsibility for improper TV mounting that results in accident, injury or damage.

8.7 Product specification

Design and specifications are subject to change without notice.

49PUT7690/V7

- With TV stand
Dimension(WxHxD): 1102 x696 x 258 (mm)
- Weight: 10.0 kg
- Without TV stand
Dimension(WxHxD): 1102 x 639 x 81 (mm)
- Weight: 9.6 kg

43PUT7690/V7

- With TV stand
Dimension(WxHxD): 970 x614 x 214 (mm)
- Weight: 8.5 kg
- Without TV stand
Dimension(WxHxD): 970 x 564 x 74 (mm)
- Weight: 8.35 kg

Consumer Guidelines

1. Kindly ensure that the dealer fills out warranty card correctly.
2. To avail the Warranty please register your product with the Philips-
 - Log on to www.Philips.com
 - OR
 - Contact Philips Consumer Care Centre
3. In the unlikely event of a defect developing in the TV set contact the Philips Customer Care Centre for obtaining warranty service and inform of the defect observed in the set, the type no. and serial no. of the set.
4. On your lodging a complaint, a trained technician will call on you promptly. In the event of the technician deciding that set requires attention at the service station, the technician would arrange to get the set picked up to be delivered to service station for further attention. "Homecalls" by the technician would however be restricted within the municipal limits of the city/town in which the set has been registered.

Type no. _____ Serial No. _____ Date of Purchase _____
Purchased By: Name _____
Address: _____
_____ Tel.No. _____
Sold by: Name _____
Address: _____
_____ Tel.No. _____

<p>PHILIPS</p> <p>Model no.: 49PUT7690/V7 43PUT7690/V7</p> <p>Serial no.: <input type="checkbox"/></p>

Sold by (User rubber stamp)

Contact Customer Service Executive at:
Toll :- 1860 200 0129

Regd Office: PE Electronics Ltd, Auto Cars Compound, Adalat Road, Aurangabad, 431005.

WARRANTY

This TV receiver is covered under warranty against any defect arising out of faulty or defective material or workmanship for a period of 12 months from the date of purchase.

Should a defect develop in this set during the period of warranty, PE Electronics Limited undertakes to get the set repaired free of charge either

from whom the set has been purchased or through an Authorised Service Center for warranty service. However, if the Purchaser has to shift his residence to another town on account of transfer or other reasons, the warranty benefit will be available at the Authorised Service Center of that town.

The warranty is not valid in case of any of the following events:

- The TV set is not used according to instructions given in the 'Direction for use' / 'User Manual'
- Defects are caused by improper or reckless use.
- Any repair work carried out by persons other than a Philips dealer or Authorised Service Center.
- Any modification or alteration of any nature made in the electrical circuitry of the set.
- This Warranty Card is not completed and signed immediately on delivery of the set by the Philips Dealer.
- Fading effects and/or Ghosts (Multiple Image) in picture, if any, arising due to location / signal reception.
- Defects due to causes beyond control like lightning, abnormal voltage, Acts of God or while in transit to purchaser's residence.

(Refer Consumer Guidelines for further details)

PHILIPS





Declaration of Conformity with the requirements of the e-waste (Management and Handling) Rules, 2011, adopted by Notification S.O.1035(E) of Ministry of Environment and Forests.

This Product is in conformity with the requirements of Rule 13 of the e-waste (Management and Handling) Rules, 2011.

The content of hazardous substance in the product, along with the exemption of the applications listed in SCHEDULE II of the (Management and Handling) Rules, 2011 are:

1. Lead (Pb) - not over 0.1 % by weight;
2. Cadmium (Cd) - not over 0.01 % by weight;
3. Mercury (Hg) - not over 0.1 % by weight;
4. Hexavalent chromium (Cr6+) - not over 0.1 % by weight;
5. Polybrominated biphenyls (PBBs) - not over 0.1 % by weight;
6. Polybrominated diphenyl ethers (PBDEs) -not over 0.1 % by weight.



The Philips trademark and the Philips Shield Emblem are registered trademarks of Koninklijke Philips N.V. used under license
www.philips.com



1100123173
LED TV 49/43"