

Register your product and get support at
www.philips.com/welcome

6101 series

User Manual

43PUH6101
49PUH6101
55PUH6101



PHILIPS

Contents

1 TV tour	4
1.1 Smart TV	4
1.2 App gallery	4
1.3 Rental videos	4
1.4 Ultra HD TV	4
1.5 Pause TV and recordings	4
1.6 Smartphones and tablets	4
2 Setting up	6
2.1 Read safety	6
2.2 TV stand and wall mounting	6
2.3 Tips on placement	6
2.4 Power cable	6
2.5 Antenna cable	6
3 Network	8
3.1 Network and Internet	8
4 Connect devices	12
4.1 About connections	12
4.2 CAM with smart card - CI+	15
4.3 Receiver - Set-Top Box	16
4.4 Home Theatre System - HTS	17
4.5 Smartphones and tablets	18
4.6 Blu-ray disc player	18
4.7 DVD player	19
4.8 Headphones	19
4.9 Game console	19
4.10 USB hard drive	20
4.11 USB keyboard	21
4.12 USB mouse	21
4.13 USB flash drive	22
4.14 Photo camera	22
4.15 Camcorder	22
4.16 Computer	22
5 Switching On and Off	24
5.1 On or standby	24
5.2 Keys on TV	24
5.3 Sleep timer	24
5.4 Switch off timer	24
6 Remote control	25
6.1 Key overview	25
6.2 IR sensor	26
6.3 Batteries	26
6.4 Cleaning	26
7 Channels	27
7.1 Install Channels	27
7.2 Switch channels	27
7.3 Channel lists	27
7.4 Watching channels	28
7.5 Text / Teletext	30
7.6 Interactive TV	31
8 TV Guide	33
8.1 What you need	33
8.2 TV guide data	33
8.3 Using the TV guide	33
9 Recording and Pause TV	35
9.1 Recording	35
9.2 Pause TV	36
10 Home menu	37
10.1 About the Home menu	37
10.2 Open the Home menu	37
11 Utilities	38
12 Netflix	39
13 Sources	40
13.1 Switch to a device	40
13.2 Options for a TV Input	40
13.3 Scan connections	40
13.4 Game or computer	40
14 Internet	41
14.1 Start Internet	41
15 Videos, photos and music	42
15.1 From a USB connection	42
15.2 From a computer	42
15.3 Menu bar and sorting	42
15.4 Play your videos	42
15.5 View your photos	42
15.6 Play your music	43
16 Smartphones and tablets	44
16.1 Philips TV Remote App	44
16.2 Miracast	44
16.3 MHL	45
16.4 Smart TV	45
17 Multi room	49
17.1 About Multi room	49
17.2 What you need	49
17.3 Using Multi room	49
18 Settings	51
18.1 Quick settings	51
18.2 Picture	51
18.3 Sound	55
18.4 Eco settings	57
18.5 General settings	58
18.6 Clock and language	60
18.7 Universal access	63
19 Networks	65
20 Channel installation	66
20.1 Antenna/cable installation	66
20.2 Channel list copy	68
21 Software	70
21.1 Update software	70
21.2 Software version	70
21.3 Local updates	70
21.4 Look for OAD updates	70
21.5 Open source software	71
21.6 Open source license	71
22 Specifications	82
22.1 Environmental	82
22.2 Power	82
22.3 Reception	83
22.4 Display type	83
22.5 Display input resolution	83
22.6 Dimensions and Weights	83
22.7 Connectivity	83
22.8 Sound	83

22.9	Multimedia	83
23	Help and support	85
23.1	Register your TV	85
23.2	Using help	85
23.3	Troubleshooting	85
23.4	Online help	87
23.5	Consumer care / Repair	87
24	Safety and care	88
24.1	Safety	88
24.2	Screen care	89
25	Terms of use	90
26	Copyrights	91
26.1	MHL	91
26.2	Ultra HD	91
26.3	HDMI	91
26.4	Dolby Digital Plus	91
26.5	DTS 2.0 + Digital Out™	91
26.6	DTVi	91
26.7	Java	91
26.8	Microsoft	91
26.9	Wi-Fi Alliance	92
26.10	Kensington	92
26.11	MHEG software	92
26.12	Other trademarks	92
Index		93

TV tour

Smart TV

Connect this **Philips Smart LED TV** to the Internet and discover a new world of television. You can make a wired connection to your router or you can link up wirelessly with Wi-Fi.

With the TV connected to your home network, a smartphone can show a photo on TV, you can play videos stored on your computer or control the TV with your tablet.

With your TV connected to the Internet, you can watch a rental video from an online video store, read the online TV guide or record your favourite TV show on a USB Hard Drive.

The Smart TV Apps add to the fun with all sorts of entertainment and convenient services.

In **Help**, press **—** **Keywords** and look up **Smart TV** for more information.

App gallery

Open the **App gallery** in Smart TV to browse the Apps, the collection of tailored websites for TV.

Find the App for YouTube videos, a national newspaper, an online photo album, Twitter, etc.

There are Apps to rent a video from an online video store and Apps for watching programmes you missed.

If the App gallery does not hold what you are looking for, try the World Wide Web and surf the Internet on TV.

In **Help**, press **—** **Keywords** and look up **App gallery** for more information.

Rental videos

To watch a **rental video**, you don't need to leave your home.

Simply rent the latest movie from your regional online video store.

Start Smart TV and add the video store App to the Smart TV **start page**.

Open the video store App, create your personal account, select the movie and press play.

No fuss with downloading, you can watch the

movie immediately*.

In **Help**, press **—** **Keywords** and look up **Rental videos** for more information.

* Depending on the video streaming service of the selected video store.

Ultra HD TV

This TV has an **Ultra HD** display. Its resolution is four times as much as normal HD displays. Ultra HD means 8 million pixels for the most refined and lifelike picture on TV.

On top, the new **Ultra Pixel HD Engine** continuously converts any incoming TV signal into Ultra HD resolution. So you can enjoy this stunning picture quality the moment you switch on the TV. Or you can watch native Ultra HD videos through an HDMI connection. Ultra HD offers TV viewing that is crisp and sharp even on a big screen.



Pause TV and recordings

If you connect a **USB Hard Drive**, you can pause and record a broadcast from a digital TV channel.

Pause your TV and answer that urgent phone call or simply take a break during a sports match, while the TV stores the broadcast on the USB Hard Drive. You can watch it again later.

With a USB Hard Drive connected, you can also record digital broadcasts. You can record while you are watching a programme or schedule a recording of an upcoming programme.

For more information, in **Help**, press the colour key **—** **Keywords** and look up **Pause TV** or **Recording**.

Smartphones and tablets

The new **Philips TV Remote App** is your new TV buddy.

With the TV Remote App on your smartphone or tablet, you master your media around you. Send photos, music or videos to your big TV screen or

watch any of your TV channels live on your tablet or phone. Open the TV Guide and schedule a recording for tomorrow. Your TV at home will do the job. With the TV Remote App you are in control. You might consider to simply lower the TV volume.

Download the Philips TV Remote App from your favourite app store today.

It's free.

The Philips TV Remote App is available for iOS and Android.

Setting up

2.1

Read safety

Read the safety instructions first before you use the TV.

To read the instructions, in **Help**, press the colour key **— Keywords** and look up **Safety instructions**.

2.2

TV stand and wall mounting

TV stand

You can find the instructions for mounting the TV stand in the Quick Start Guide that came with the TV. In case you lost this guide, you can download it from www.philips.com.

Use the product type number of the TV to look for the **Quick Start Guide** to download.

Wall mounting

Your TV is also prepared for a VESA-compliant wall mount bracket (sold separately).

Use the following VESA code when purchasing the wall mount . . .

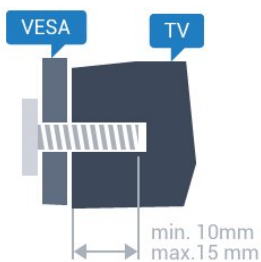

- 43PUx6101
VESA MIS-F 200x200, M6
- 49PUx6101
VESA MIS-F 400x200, M6
- 55PUx6101
VESA MIS-F 400x200, M6

Preparation

First remove the 4 plastic screw caps out of the threaded bushes on the back of the TV. Make sure that the metal screws, to mount the TV to the VESA-compliant bracket, go about 10mm deep inside the threaded bushes of the TV.

Caution

Wall mounting the TV requires special skills and

should only be performed by qualified personnel. The TV wall mounting should meet safety standards according to the TV's weight. Also read the safety precautions before positioning the TV. TP Vision Europe B.V. bears no responsibility for improper mounting or any mounting that results in accident or injury.

2.3

Tips on placement

- Position the TV where light does not shine directly on the screen.
- Position the TV up to 15 cm away from the wall.
- The ideal distance to watch TV is 3 times its diagonal screen size. When seated, your eyes should be level with the centre of the screen.



2.4

Power cable

- Insert the power cable into the **POWER** connector on the back of the TV.
- Make sure the power cable is securely inserted in the connector.
- Make sure that the power plug, in the wall socket, is accessible at all times.
- When you unplug the power cable, always pull the plug, never pull the cable.

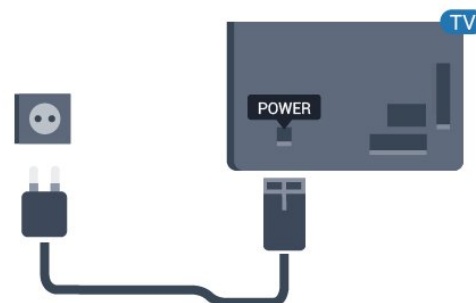

Although this TV has a very low standby power consumption, unplug the power cable to save energy if you do not use the TV for a long period of time.

For more information, in **Help**, press the colour key **— Keywords** and look up **Switching on** for more information.

Antenna cable

Insert the antenna plug firmly into the **Antenna** socket at the back of the TV.

You can connect your own antenna or an antenna signal from an antenna distribution system. Use an IEC Coax 75 Ohm RF antenna connector.

Use this antenna connection for DVB-T and DVB-C input signals.

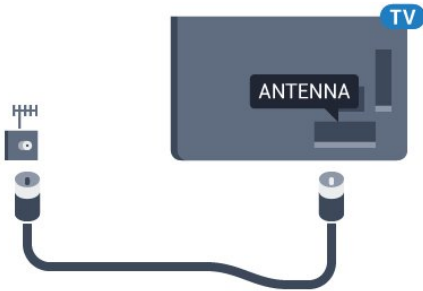

Network

Network and Internet

Home network

To enjoy the full capabilities of your Philips TV, your TV must be connected to the Internet.

Connect the TV to a home network with a high-speed Internet connection. You can connect your TV wirelessly or wired to your network router.

Connect to network

Wireless connection

What you need

To connect the TV to the Internet wirelessly, you need a Wi-Fi router with a connection to the Internet.

Use a high-speed (broadband) connection to the Internet.



Make the connection

Wireless

To make a wireless connection...

- 1 - Make sure that the router of your wireless network is switched on.
- 2 - Press **⚙️**, select **Network** and press **➤** (right) to enter the menu.
- 3 - Select **Connect to network** and press **OK**.
- 4 - Select **Wireless** and press **OK**.
- 5 - In the list of found networks, select on your wireless network. If your network is not in the list because the network name is hidden (you switched off the SSID broadcast of the router), select **Manual entry** to enter the network name yourself.
- 6 - Depending on the type of router, enter your encryption key - WEP, WPA or WPA2. If you entered the encryption key for this network before, you can

select **Done** to make the connection immediately. If your router supports WPS or WPS PIN, you select **WPS**, **WPS PIN** or **Standard**. Select your choice and press **OK**.
7 - A message will be shown when the connection is successful.

WPS

If your router has WPS, you can directly connect to the router without scanning for networks. If you have devices in your wireless network that use the WEP security encryption system, you cannot use WPS.

- 1 - Press **⚙️**, select **Network** and press **➤** (right) to enter the menu.
- 2 - Select **Connect to network** and press **OK**.
- 3 - Select **WPS** then press **OK**.
- 4 - Go to the router, press the WPS button and return to the TV within 2 minutes.
- 5 - Select **Connect** to make the connection.
- 6 - A message will be shown when the connection is successful.

WPS with PIN code

If your router has WPS with a PIN code, you can directly connect to the router without scanning for networks. If you have devices in your wireless network that use the WEP security encryption system, you cannot use WPS.

- 1 - Press **⚙️**, select **Network** and press **➤** (right) to enter the menu.
- 2 - Select **Connect to network** and press **OK**.
- 3 - Select **WPS with PIN code** and press **OK**.
- 4 - Write down the 8-digit PIN code shown on screen and enter it in the router software on your PC. Consult the router manual on where to enter the PIN code in the router software.
- 5 - Select **Connect** to make the connection.
- 6 - A message will be shown when the connection is successful.

Problems

Wireless network not found or distorted

- Microwave ovens, DECT phones or other Wi-Fi 802.11b/g/n devices in your proximity might disturb the wireless network.
- Make sure that the firewalls in your network allow access to the TV's wireless connection.
- If the wireless network does not work properly in your home, try the wired network installation.

Internet does not work

- If the connection to the router is OK, check the router connection to the Internet.

The PC and Internet connection are slow

- Look in your wireless router's user manual for information on indoor range, transfer rate and other factors of signal quality.
- Use a high-speed (broadband) Internet connection for your router.

DHCP

- If the connection fails, you can check the DHCP (Dynamic Host Configuration Protocol) setting of the router. DHCP should be switched on.

Wired connection

What you need

To connect the TV to the Internet, you need a network router with a connection to the Internet.

Use a high-speed (broadband) connection to the Internet.

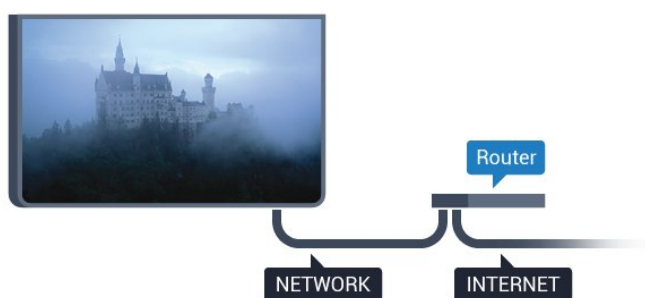

Make the connection

To make a wired connection...

- 1 - Connect the router to the TV with a network cable (Ethernet cable**).
- 2 - Make sure that the router is switched on.
- 3 - Press **⚙️**, select **Network** and press **➤** (right) to enter the menu.
- 4 - Select **Connect to network** and press **OK**.
- 5 - Select **Wired** and press **OK**. The TV constantly searches for the network connection.
- 6 - A message will be shown when the connection is successful.

If the connection fails, you can check the DHCP setting of the router. DHCP should be switched on.

**To fulfill EMC regulations, use a shielded FTP Cat. 5E Ethernet cable.

Network settings

View network settings

You can view all current network settings here. The IP and MAC address, signal strength, speed, encryption method, etc.

To view the current network settings...

- 1 - Press **⚙️**, select **Network** and press **➤** (right) to enter the menu.
- 2 - Select **View network settings** and press **OK**.
- 3 - Press **⬅** (left) repeatedly if necessary, to close the menu.

Network configuration

If you are an advanced user and want to install your network with Static IP addressing, set the TV to **Static IP**.

To set the TV to Static IP...

- 1 - Press **⚙️**, select **Network** and press **➤** (right) to enter the menu.
- 2 - Select **Network configuration** and press **OK**.
- 3 - Select **Static IP** and press **OK** to enable **Static IP configuration**.
- 4 - Select **Static IP configuration** and configure the connection.
- 5 - You can set the number for **IP address**, **Netmask**, **Gateway**, **DNS 1**, or **DNS 2**.
- 6 - Press **⬅** (left) repeatedly if necessary, to close the menu.

Switch On with Wi-Fi (WoWLAN)

You can switch this TV on from your smartphone or tablet if the TV is in Standby. The setting **Switch On with Wi-Fi (WoWLAN)** must be switched on.

To switch on WoWLAN...

- 1 - Press **⚙️**, select **Network** and press **➤** (right) to enter the menu.
- 2 - Select **Switch on with Wi-Fi (WoWLAN)** and press **OK**.
- 3 - Select **On** and press **OK**.
- 4 - Press **⬅** (left) repeatedly if necessary, to close the menu.

Digital Media Renderer - DMR

If your media files do not play on your TV, make sure that the Digital Media Renderer is switched on. As a factory setting, DMR is switched on.

To switch on DMR...

- 1 - Press **⚙️**, select **Network** and press **➤** (right) to

enter the menu.

- 2 - Select **Digital Media Renderer - DMR** and press **OK**.
- 3 - Select **On** and press **OK**.
- 4 - Press **◀** (left) repeatedly if necessary, to close the menu.

Switch on Wi-Fi connection

You can switch on or off Wi-Fi connection on your TV.

To switch on Wi-Fi...

- 1 - Press **⚙**, select **Network** and press **▶** (right) to enter the menu.
- 2 - Select **Wi-Fi On/Off** and press **OK**.
- 3 - Select **On** and press **OK**.
- 4 - Press **◀** (left) repeatedly if necessary, to close the menu.

Switch on Wi-Fi Miracast

Switch on Wi-Fi Miracast to share the screen of your smartphone, tablet or computer on the TV.

To switch on Miracast...

- 1 - Press **⚙**, select **Network** and press **▶** (right) to enter the menu.
- 2 - Select **Wi-Fi Miracast** and press **OK**.
- 3 - Select **On** and press **OK**.
- 4 - Press **◀** (left) repeatedly if necessary, to close the menu.

For more information, in **Help**, press the colour key **■** **Keywords** and look up **Miracast™**, switch on.

Reset Wi-Fi Miracast connections

Clear the list of connected and blocked devices that are used with Miracast.

To clear Miracast connections...

- 1 - Press **⚙**, select **Network** and press **▶** (right) to enter the menu.
- 2 - Select **Reset Wi-Fi Miracast connections** and press **OK**.
- 3 - Select **Clear all** and press **OK**.
- 4 - Press **◀** (left) repeatedly if necessary, to close the menu.

Wi-Fi smart screen

To watch digital TV channels on your smartphone or tablet with the Philips TV Remote App, you must switch on Wi-Fi Smart Screen. Some scrambled channels might not be available on your mobile

device.

To switch on Wi-Fi Smart Screen...

- 1 - Press **⚙**, select **Network** and press **▶** (right) to enter the menu.
- 2 - Select **Wi-Fi smart screen** and press **OK**.
- 3 - Select **On** and press **OK**.
- 4 - Press **◀** (left) repeatedly if necessary, to close the menu.

TV network name

If you have more than one TV in your home network, you can give the TV a unique name.

To change the TV name...

- 1 - Press **⚙**, select **Network** and press **▶** (right) to enter the menu.
- 2 - Select **TV network name** and press **OK**.
- 3 - Enter the name with the on-screen keyboard.
- 4 - Select **Done** to confirm the change.
- 5 - Press **◀** (left) repeatedly if necessary, to close the menu.

Netflix settings

With **Netflix settings**, you can view ESN number or deactivate Netflix device.

To enter **Netflix settings**...

- 1 - Press **⚙**, select **Network** and press **▶** (right) to enter the menu.
- 2 - Select **Netflix settings** and press **OK**.
- 3 - Press **◀** (left) repeatedly if necessary, to close the menu.

Clear Internet memory

With **Clear Internet Memory**, you can clear all Internet files and logins stored on your TV, such as passwords, cookies, and history.

To clear the Internet memory...

- 1 - Press **⚙**, select **Network** and press **▶** (right) to enter the menu.
- 2 - Select **Clear Internet memory** and press **OK**.
- 3 - Select **OK** to confirm.
- 4 - Press **◀** (left) repeatedly if necessary, to close the menu.

File sharing

The TV can connect to other devices in your wireless network, like your computer or smartphone. You can use a computer with Microsoft Windows or Apple OS X.

On this TV, you can open photos, music and videos stored on your computer.

Connect devices

4.1

About connections

Connectivity guide

Always connect a device to the TV with the highest quality connection available. Also, use good quality cables to ensure a good transfer of picture and sound.

When you connect a device, the TV recognizes its type and gives each device a correct type name. You can change the type name if you wish. If a correct type name for a device is set, the TV automatically switches to the ideal TV settings when you switch to this device in the Sources menu.

If you need help to connect several devices to the TV, you can visit the Philips TV connectivity guide. The guide offers information on how to connect and which cables to use.

Go to www.connectivityguide.philips.com

Antenna port

If you have a Set-top box (a digital receiver) or Recorder, connect the antenna cables to run the antenna signal through the Set-top box and/or Recorder first before it enters the TV. In this way, the antenna and the Set-top box can send possible additional channels to the Recorder to record.

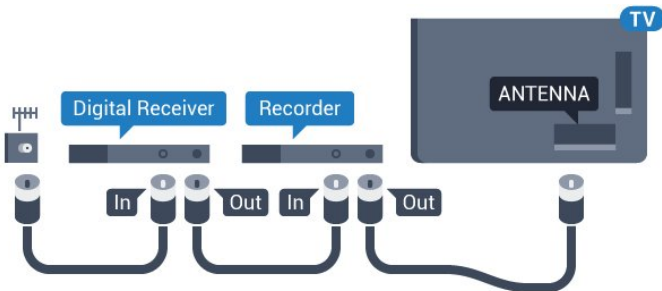

HDMI ports

HDMI quality

An HDMI connection has the best picture and sound quality. One HDMI cable combines video and audio signals. Use an HDMI cable for TV signal.

For best signal quality transfer, use a High speed HDMI cable and do not use an HDMI cable longer than 5 m.

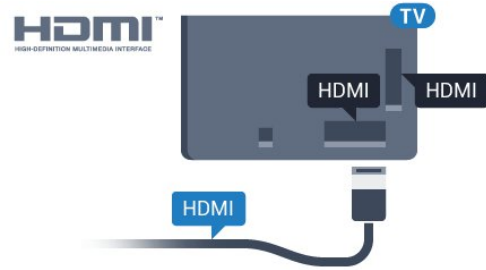

Copy protection

HDMI cables support HDCP (High-bandwidth Digital Content Protection). HDCP is a copy protection signal that prevents copying content from a DVD disc or Blu-ray Disc. Also referred to as DRM (Digital Rights Management).

HDMI ARC

Only **HDMI 1** on the TV have **HDMI ARC** (Audio Return Channel).

If the device, typically a Home Theatre System (HTS), also has the HDMI ARC connection, connect it to **HDMI 1** connection on this TV. With the HDMI ARC connection, you do not need to connect the extra audio cable that sends the sound of the TV picture to the HTS. The HDMI ARC connection combines both signals.

HDMI MHL

With **HDMI MHL**, you can send what you see on your Android smartphone or tablet to a TV screen.

The **HDMI 4** connection on this TV incorporates **MHL 2.0** (Mobile High-Definition Link).

This wired connection offers great stability and bandwidth, low latency, no wireless interference and good quality sound reproduction. On top of that, the MHL connection will charge the battery of your smartphone or tablet. Although connected, your mobile device will not be charging when the TV is on standby.

Inform yourself about what passive MHL cable is suited for your mobile device. In particular, with the HDMI connector for the TV on one side, the type of connector you need to connect to your smartphone or tablet.

MHL, Mobile High-Definition Link and the MHL Logo are trademarks or registered trademarks of the MHL, LLC.



HDMI Ultra HD

This TV can display Ultra HD signals. Some devices - connected with HDMI - do not recognise a TV with Ultra HD and might not work correctly or show distorted picture or sound. To avoid the malfunctioning of such a device, you can set the signal quality to a level the device can handle. If the device is not using Ultra HD signals, you can switch off Ultra HD for this HDMI connection.

The setting **UHD 4:4:4/4:2:2** allows UHD YCbCr 4:4:4 / 4:2:2 signals. The setting **UHD 4:2:0** allows UHD YCbCr 4:2:0 signals.

To set the signal quality...

- 1 - Press **⚙**, select **General settings** and press **➤** (right) to enter the menu.
- 2 - Select **HDMI Ultra HD > HDMI 3 & 4** and press **OK**.
- 3 - Select **UHD 4:4:4/4:2:2**, **UHD 4:2:0** or **UHD Off** and press **OK**.
- 4 - Press **⬅** (left) repeatedly if necessary, to close the menu.

HDMI CEC - EasyLink

EasyLink

An HDMI connection has the best picture and sound quality. One HDMI cable combines video and audio signals. Use an HDMI cable for High Definition (HD) TV signals. For best signal quality transfer, use a High speed HDMI cable and do not use an HDMI cable longer than 5 m.

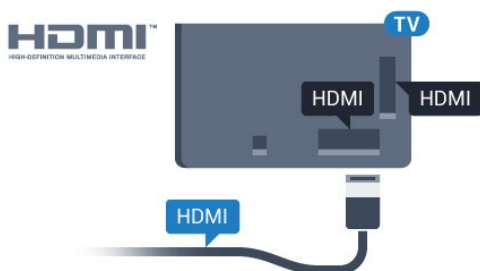

EasyLink HDMI CEC

If your devices are connected with HDMI and have EasyLink, you can operate them with the TV remote control. EasyLink HDMI CEC must be switched On on the TV and the connected device.

With EasyLink you can operate a connected device with the TV remote control. EasyLink uses HDMI CEC (Consumer Electronics Control) to communicate with the connected devices. Devices must support HDMI CEC and must be connected with an HDMI connection.

EasyLink setup

The TV comes with EasyLink switched on. Make sure

that all HDMI CEC settings are properly set up on the connected EasyLink devices. EasyLink might not work with devices from other brands.

HDMI CEC on other brands

The HDMI CEC functionality has different names on different brands. Some examples are: Anynet, Aquos Link, Bravia Theatre Sync, Kuro Link, Simplink and Viera Link. Not all brands are fully compatible with EasyLink.

Example HDMI CEC branding names are property of their respective owners.

Operate devices

To operate a device connected to HDMI and set up with EasyLink, select the device or its activity in the list of TV connections. Press **➤ SOURCES**, select a device connected to an HDMI connection and press **OK**.

Once the device is selected, the TV remote control can control the device. However the keys **🏠 Home** and **☰ OPTIONS** and some other TV keys, are not forwarded to the device.

If the key you need is not on the TV remote control, you can select the key in the Options menu.

Press **☰ OPTIONS** and select **Controls** in the menu bar. On the screen, select the device key you need and press **OK**.

Some very specific device keys might not be available in the Controls menu.

Only devices that support **EasyLink Remote Control** function will respond to the TV remote control.

EasyLink On or Off

You can switch EasyLink on or off. The TV comes with the EasyLink settings switched on.

To switch off EasyLink completely...

- 1 - Press **⚙**, select **General settings** and press **➤** (right) to enter the menu.
- 2 - Select **EasyLink**, press **➤** (right) and select **EasyLink** one step further.
- 3 - Select **Off**.
- 4 - Press **⬅** (left) repeatedly if necessary, to close the menu.

EasyLink remote control

If you want devices to communicate but you don't want to operate them with the TV remote control, you can switch off EasyLink Remote Control separately.

To switch EasyLink Remote Control on or off...

- 1 - Press , select **General settings** and press **>** (right) to enter the menu.
- 2 - Select **EasyLink > EasyLink Remote Control** and press **OK**.
- 3 - Select **On** or **Off** and press **OK**.
- 4 - Press **<** (left) repeatedly if necessary, to close the menu.

Pixel Plus Link

Some devices, a DVD or Blu-ray Disc player, might have their own picture quality processing. To avoid bad picture quality caused by interference with the TV processing, the picture processing of these devices should be disabled. The TV comes with Pixel Plus Link switched on and disables the picture quality processing of recent Philips devices connected to the TV.

To switch **Pixel Plus Link** on or off...

- 1 - Press , select **General settings** and press **>** (right) to enter the menu.
- 2 - Select **EasyLink > Pixel Plus Link** and press **OK**.
- 3 - Select **On** or **Off** and press **OK**.
- 4 - Press **<** (left) repeatedly if necessary, to close the menu.

Auto switch off devices

You can set the TV to switch off the connecting HDMI-CEC compliant devices if they are not the active source. The TV switches the connected device to standby after 10 minutes of inactivity.

DVI to HDMI

If you still own a device that only has a DVI connection, you can connect the device to any of the **HDMI** connection with a DVI to HDMI adapter.

Use a DVI to HDMI adapter if your device only has a DVI connection. Use one of the HDMI connections and add an Audio L/R cable (mini-jack 3.5mm) to Audio In for sound, on the back of the TV.

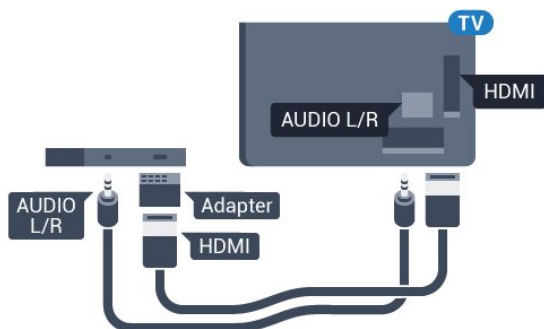

Copy protection

DVI and HDMI cables support HDCP (High-bandwidth Digital Content Protection). HDCP is a copy protection signal that prevents copying content from a DVD disc or Blu-ray Disc. Also referred to as DRM (Digital Rights Management).

Y Pb Pr - Component

Y Pb Pr - Component Video is a high quality connection.

The YPbPr connection can be used for High Definition (HD) TV signals. Next to the Y, Pb and Pr signals add the Audio Left and Right signals for sound.

Match the YPbPr (green, blue, red) connector colours with the cable plugs when you connect. Use an Audio L/R cinch cable if your device also has sound.

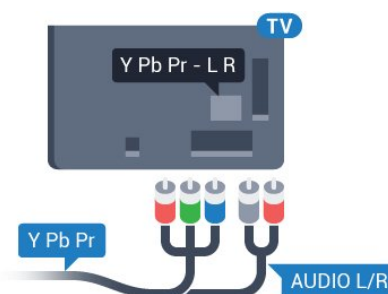

CVBS - Audio L R

CVBS - Composite Video is a high quality connection. Next to the CVBS signal adds the Audio Left and Right signals for sound.

- Y shares the same jack with CVBS.
- Component and Composite share audio jacks.

Audio Out - Optical

Audio Out - Optical is a high quality sound connection.

This optical connection can carry 5.1 audio channels. If your device, typically a Home Theatre System (HTS), has no HDMI ARC connection, you can use this connection with the Audio In - Optical connection on the HTS. The Audio Out - Optical connection sends the sound from the TV to the HTS.

You can set the type of the audio out signal to fit the audio capabilities of your Home Theatre System. For more information, in **Help**, press the colour key **— Keywords** and look up **Audio out settings**.

If the sound does not match the video on screen, you can adjust the audio to video synchronisation. For more information, in **Help**, press the colour key **— Keywords** and look up **Audio to video sync**.

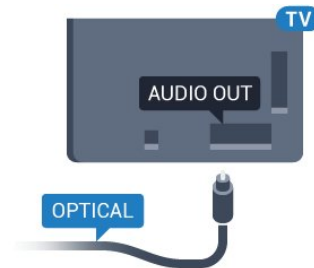

4.2

CAM with smart card - CI+

CI+

This TV is ready for the CI+ Conditional Access.

With CI+ you can watch premium HD programmes, like movies and sports, offered by digital TV operators in your region. These programmes are scrambled by the TV operator and descrambled with a prepaid CI+ module.

Digital TV operators provide a CI+ module (Conditional Access Module - CAM) and an accompanying smart card, when you subscribe to their premium programmes. These programmes have a high level of copy protection.

Contact a digital TV operator for more information on terms & conditions.



Scart

SCART is a good quality connection.

The SCART connection can be used for CVBS and RGB video signals but cannot be used for High Definition (HD) TV signals. The SCART connection combines video and audio signals. The SCART connection also supports NTSC playback.

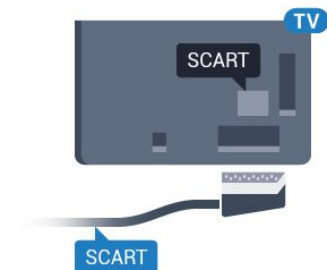

Smart card

Digital TV operators provide a CI+ module (Conditional Access Module - CAM) and an accompanying smart card, when you subscribe to their premium programmes.

Insert the smart card into the CAM module. See the instruction you received from the operator.

To insert the CAM in the TV...

- 1 - Look on the CAM for the correct method of insertion. Incorrect insertion can damage the CAM and TV.
- 2 - While looking at the back of the TV, with the front of the CAM facing towards you, gently insert the CAM into the slot **COMMON INTERFACE**.
- 3 - Push the CAM in as far as it will go. Leave it in the slot permanently.

When you switch on the TV, it may take a few minutes before the CAM is activated. If a CAM is inserted and subscription fees are paid (subscription methods can differ), you can watch the scrambled channels supported by the CAM smart card.

The CAM and smart card are exclusively for your TV. If you remove the CAM, you will no longer be able to watch the scrambled channels supported by the CAM.

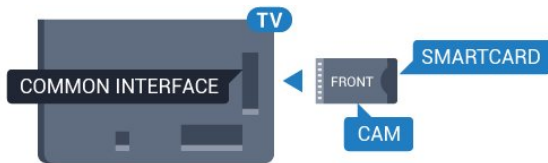

Passwords and PIN codes

For some CAMs, you must enter a PIN code to watch its channels. When you set the PIN code for the CAM, we recommend you to use the same code you are using to unlock the TV.

To set the PIN code for the CAM...

- 1 - Press **SOURCES**.
- 2 - Select the channel type you are using the CAM for.
- 3 - Press **OPTIONS** and select **Common Interface**.
- 4 - Select the TV operator of the CAM. The following screens come from the TV operator. Follow the on-screen instruction to look up the PIN code setting.

4.3

Receiver - Set-Top Box

Cable box

Use 2 antenna cables to connect the antenna to the Set-top box (a digital receiver) and the TV.

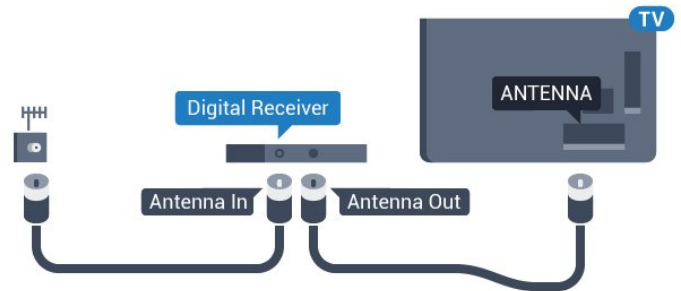

Next to the antenna connections, add an HDMI cable to connect the Set-top box to the TV. Alternatively, you can use a SCART cable if the Set-top box has no HDMI connection.

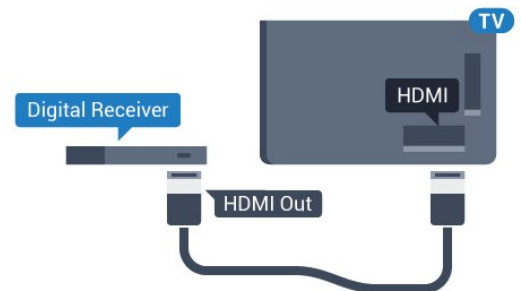

Switch Off Timer

Switch off this automatic timer, if you only use the remote control of the Set-top box. Switch this timer off to prevent the TV from switching off automatically after a 4 hour period without a key press on the remote control of the TV.

For more information, in **Help**, press the colour key **Keywords** and look up **Switch off timer** for more information.

Satellite tuner

Connect the dish antenna cable to the Satellite receiver.

Next to the antenna connection, add an HDMI cable to connect the device to the TV.

Alternatively, you can use a SCART cable if the device has no HDMI connection.

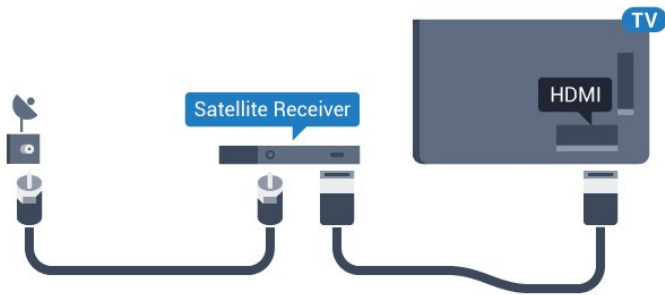

Switch Off Timer

Switch off this automatic timer, if you only use the remote control of the Set-top box. Switch this timer off to prevent the TV from switching off automatically after a 4 hour period without a key press on the remote control of the TV.

For more information, in **Help**, press the colour key **— Keywords** and look up **Switch off timer** for more information.

4.4

Home Theatre System - HTS

Connect with HDMI ARC

Use an HDMI cable to connect a Home Theatre System (HTS) to the TV. You can connect a Philips Soundbar or an HTS with a built-in disc player.

HDMI ARC

If your Home Theatre System has an HDMI ARC connection, you can use **HDMI 1** on the TV to connect. With HDMI ARC, you do not need to connect the extra audio cable. The HDMI ARC connection combines both signals.

HDMI 1 on the TV can offer the Audio Return Channel (ARC) signal. But once you have connected the Home Theatre System, the TV can only send the ARC signal to this HDMI connection.

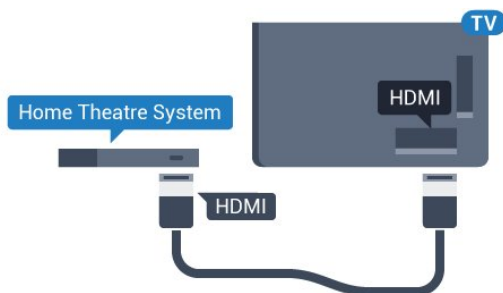

Audio to video synchronisation (sync)

If the sound does not match the video on screen, you can set a delay on most Home Theatre Systems with a disc player to match the sound with the video.

For more information, in **Help**, press the colour key **— Keywords** and look up **Audio to video sync**.

Connect with HDMI

Use an HDMI cable to connect a Home Theatre System (HTS) to the TV. You can connect a Philips Soundbar or an HTS with a built-in disc player.

If the Home Theatre System has no HDMI ARC connection, add an optical audio cable (Toslink) to send the sound of the TV picture to the Home Theatre System.

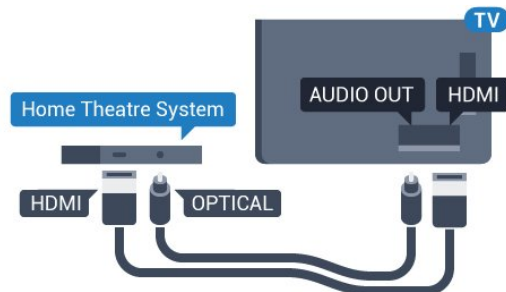

Audio to video synchronisation (sync)

If the sound does not match the video on screen, you can set a delay on most Home Theatre Systems with a disc player to match the sound with the video.

For more information, in **Help**, press the colour key **— Keywords** and look up **Audio to video sync**.

Audio out settings

Audio out delay

With a Home Theatre System (HTS) connected to the TV, the picture on TV and the sound from the HTS should be synchronised.

Automatic audio to video sync

With recent Philips Home Theatre Systems, the audio to video sync is done automatically and always correct.

Audio sync delay

For some Home Theatre Systems you might need to adjust the audio sync delay to synchronise the audio to the video. On the HTS, increase the delay value until there is a match between picture and sound. A delay value of 180ms may be required. Read the user manual of the HTS. With a delay value set up on the HTS, you need to switch off Audio Out Delay on the TV.

To switch off Audio Out Delay...

- 1 - Press **⚙**, select **Sound** and press **➤** (right) to enter the menu.
- 2 - Select **Advanced > Audio out delay** and press **OK**.
- 3 - Select **Off**.
- 4 - Press **⬅** (left) repeatedly if necessary, to close

the menu.

Audio out offset

If you cannot set a delay on the Home Theatre System, you can set the TV to sync the sound. You can set an offset that compensates for the time necessary for the Home Theatre System to process the sound of the TV picture. You can set the value in steps of 5ms. Maximum setting is -60ms.

The **Audio out delay** setting should be switched on.

To synchronise the sound on the TV...

- 1 - Press **⚙️**, select **Sound** and press **➤** (right) to enter the menu.
- 2 - Select **Advanced > Audio out offset** and press **OK**.
- 3 - Use the slider bar to set the sound offset and press **OK**.
- 4 - Press **◀** (left) repeatedly if necessary, to close the menu.

Audio out format

If you have a Home Theatre System (HTS) with multichannel sound processing capabilities like Dolby Digital, DTS® or similar, set the Audio Out Format to Multichannel. With Multichannel, the TV can send the compressed multichannel sound signal from a TV channel or connected player to the Home Theatre System. If you have a Home Theatre System without multichannel sound processing, select Stereo.

To set **Audio out format**...

- 1 - Press **⚙️**, select **Sound** and press **➤** (right) to enter the menu.
- 2 - Select **Advanced > Audio out format** and press **OK**.
- 3 - Select **Multichannel** or **Stereo (uncompressed)**, then press **OK**.
- 4 - Press **◀** (left) repeatedly if necessary, to close the menu.

Audio out levelling

Use the Audio Out Levelling setting to level the volume (loudness) of the TV and the Home Theatre System when you switch over from one to another. Volume differences can be caused by differences in sound processing.

To level the difference in volume...

- 1 - Press **⚙️**, select **Sound** and press **➤** (right) to enter the menu.
- 2 - Select **Advanced > Audio out levelling** and press **OK**.
- 3 - Select **More**, **Medium**, or **Less**, then press **OK**.

4 - If the volume difference is large, select **More**. If the volume difference is small, select **Less**.

5 - Press **◀** (left) repeatedly if necessary, to close the menu.

Audio Out Levelling affects both the Audio Out - Optical and HDMI ARC sound signals.

Problems with HTS sound

Sound with loud noise

If you watch a video from a plugged in USB flash drive or connected computer, the sound from your Home Theatre System might be distorted. This noise is heard when the audio or video file has DTS sound but the Home Theatre System has no DTS sound processing. You can fix this by setting the **Audio out format** of the TV to **Stereo (uncompressed)**.

Press **⚙️** for **Sound > Advanced > Audio out format**.

No sound

If you cannot hear the sound from the TV on your Home Theatre System, check if you connected the HDMI cable to an **HDMI1 ARC** connection on the Home Theatre System.

4.5

Smartphones and tablets

To connect a smartphone or tablet to the TV, you can use a wireless or wired connection.

Wireless

For a wireless connection, on your smartphone or tablet download the Philips TV Remote App from your favourite app store.

Wired

For a wired connection, use the HDMI 4 MHL connection on the back of the TV. In **Help**, press the colour key **■** **Keywords** and look up **HDMI MHL** for more information.

4.6

Blu-ray disc player

Use a **High speed HDMI** cable to connect the Blu-ray Disc player to the TV.

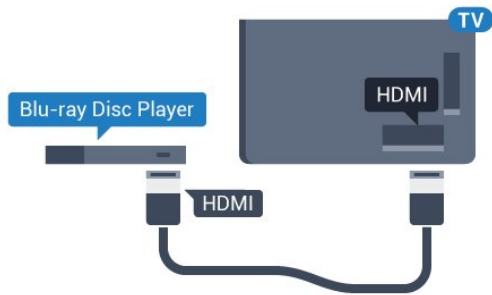

If the Blu-ray Disc player has EasyLink HDMI CEC, you can operate the player with the TV remote control.

4.7

DVD player

Use an HDMI cable to connect the DVD player to the TV.

Alternatively, you can use a SCART cable, if the device has no HDMI connection.

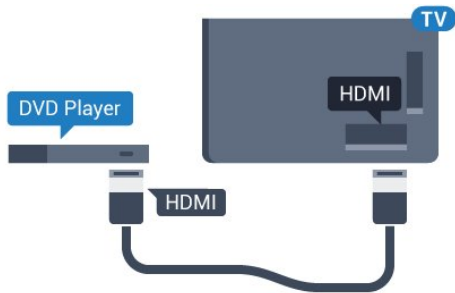

If the DVD player is connected with HDMI and has EasyLink CEC, you can operate the player with the TV remote control.

For more information on EasyLink, in **Help**, press the colour key **—** **Keywords** and look up **EasyLink HDMI CEC**.



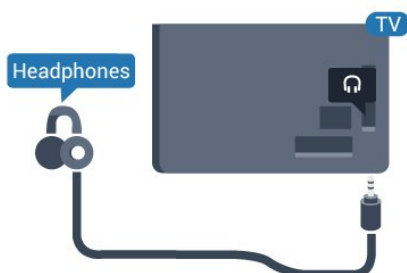

4.8

Headphones

You can connect a set of headphones to the  connection on the back of the TV. The connection is a mini-jack 3.5mm. You can adjust the volume of the headphones separately.



To adjust the volume...

- 1 - Press , select **Sound** > **Headphone volume** and press **OK**.
- 2 - Press the arrows  (up) or  (down) to adjust the value.
- 3 - Press  (left) repeatedly if necessary, to close the menu.

4.9

Game console

HDMI

For best quality, connect the game console with a High speed HDMI cable to the TV.

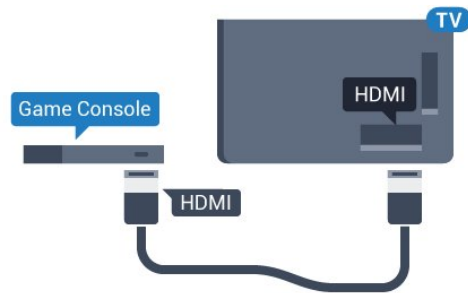

Y Pb Pr - Component

Connect the game console with a component video cable (Y Pb Pr) and an audio L/R cable to the TV.

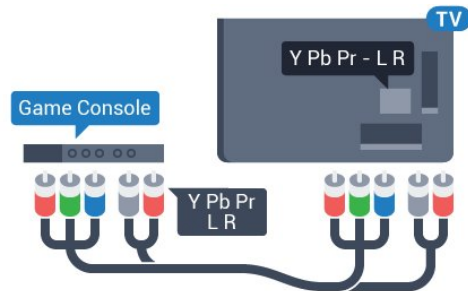

CVBS - Audio L R

CVBS - Composite Video is a high quality connection. Next to the CVBS signal adds the Audio Left and Right signals for sound.

- Y shares the same jack with CVBS.
- Component and Composite share audio jacks.

Scart

Connect the game console to the TV with a composite cable (CVBS) and an audio L/R cable to the TV.

If your game console only has Video (CVBS) and Audio L/R output, use a Video Audio L/R to SCART adapter (sold separately) to connect to the SCART connection.

Best setting

Before you start playing a game from a connected game console, we advise you to set the TV in the ideal setting **Game**.

When you finish playing a game and start watching TV again, remember to switch the **Game or Computer** setting back to **Off**.

To set the TV to the ideal setting...

1 - Press , select **Picture** and press **>** (right) to enter the menu.

2 - Select **Advanced > Game or Computer**, and select the device type you want to use. To switch back to TV, select **Off**.

3 - Press **<** (left) repeatedly if necessary, to close the menu.

4.10

USB hard drive

What you need

If you connect a USB Hard Drive, you can pause or record a TV broadcast. The TV broadcast must be a digital broadcast (DVB broadcast or similar).

To Pause

To pause a broadcast, you need a USB compatible Hard Drive with a minimum of 4GB disk space.

To Record

To pause and record a broadcast, you need a minimum of 250GB disk space. If you want to record a broadcast with TV guide data from the Internet, you need to have the Internet connection installed on your TV before you install the USB Hard Drive.

For more information on how to install a USB Hard Drive, in **Help**, press the colour key  **Keywords** and look up **USB hard drive, installation**.

Installation

Before you can pause or record a broadcast, you must connect and format a USB Hard Drive. Formatting removes all files from the USB Hard Drive.

1 - Connect the USB Hard Drive to one of the **USB** connections on the TV. Do not connect another USB device to the other USB ports when formatting.

2 - Switch on the USB Hard Drive and the TV.

3 - When the TV is tuned to a digital TV channel, press **||** (Pause). Trying to pause will start the formatting.

Follow the instructions on screen.

When the USB Hard Drive is formatted, leave it connected permanently.

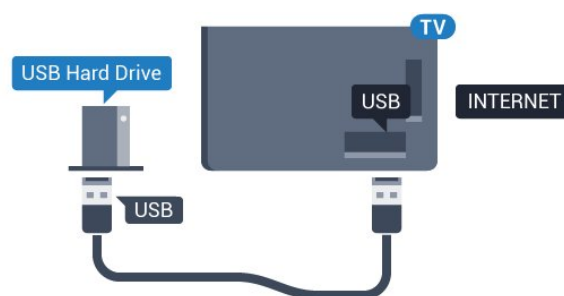

Warning

The USB Hard Drive is formatted exclusively for this TV, you cannot use the stored recordings on another TV or PC. Do not copy or change recording files on the USB Hard Drive with any PC application. This will corrupt your recordings. When you format another USB Hard Drive, the content on the former will be lost. A USB Hard Drive installed on your TV will need reformatting for use with a computer.

Formatting

Before you can pause or record a broadcast, you must connect and format a USB Hard Drive.

Formatting removes all files from the USB Hard Drive. If you want to record broadcasts with TV Guide data from the Internet, you must setup the Internet connection first before you install the USB Hard Drive.

Warning

The USB Hard Drive is formatted exclusively for this TV, you cannot use the stored recordings on another TV or PC. Do not copy or change recording files on the USB Hard Drive with any PC application. This will corrupt your recordings. When you format another USB Hard Drive, the content on the former will be lost. A USB Hard Drive installed on your TV will need reformatting for use with a computer.

To format a USB Hard Drive...

- 1 - Connect the USB Hard Drive to one of the USB connections on the TV. Do not connect another USB device to the other USB ports when formatting.
- 2 - Switch on the USB Hard Drive and the TV.
- 3 - When the TV is tuned to a digital TV channel, press **||** (Pause). Trying to pause will start the formatting. Follow the instructions on screen.
- 4 - The TV will ask if you want to use the USB Hard Drive to store apps, agree to the question if you do.
- 5 - When the USB Hard Drive is formatted, leave it connected permanently.

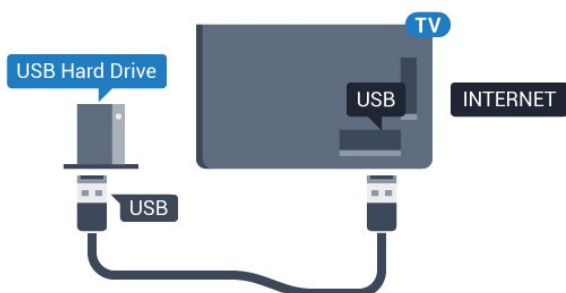

4.11

USB keyboard

Connect

Connect a USB keyboard (USB-HID type) to enter text on your TV.

Use one of the USB connections to connect.



Configure

To install the USB keyboard, switch on the TV and connect the USB keyboard to one of the USB connections on the TV. When the TV detects the keyboard for the first time, you can select your keyboard lay-out and test your selection. If you select a Cyrillic or Greek keyboard layout first, you can select a secondary Latin keyboard layout.

To change the keyboard layout setting when a layout was selected...

- 1 - Press **⚙️**, select **General settings** and press **➤** (right) to enter the menu.
- 2 - Select **USB keyboard settings**, and press **OK** to start the keyboard setup.

Special keys

Keys for entering text

- Enter key = OK
- Backspace = delete character before cursor
- Arrow keys = navigate within a text field
- To switch between keyboard layouts, if a secondary layout is set, press the **Ctrl + Spacebar** keys simultaneously.

Keys for apps and Internet pages

- Tab and Shift + Tab = Next and Previous
- Home = scroll to the top of the page
- End = scroll to the bottom of the page
- Page Up = jump one page up
- Page Down = jump one page down
- + = zoom in one step
- - = zoom out one step
- * = fit the web page to the screen width

4.12

USB mouse

Connect USB mouse

You can connect a USB mouse (USB-HID type) to navigate pages on the Internet.

On an Internet page, you can select and click on links more easily.

Connect the mouse

Switch the TV on and connect the USB mouse to one of the USB connections on the TV. You can also connect the USB mouse to a connected USB keyboard.

Mouse clicks

- Left click = OK

You can use the scroll wheel to scroll pages up and down.

Mouse speed

To install the USB keyboard, switch on the TV and connect the USB keyboard to one of the USB connections on the TV. When the TV detects the keyboard for the first time, you can select your keyboard lay-out and test your selection. If you select a Cyrillic or Greek keyboard layout first, you can select a secondary Latin keyboard layout.

To change the keyboard layout setting when a layout was selected...

- 1 - Press **⚙️**, select **General settings** and press **➤** (right) to enter the menu.
- 2 - Select **Mouse settings**, and press **OK** to start

the keyboard setup.

4.13

USB flash drive

You can view photos or play your music and videos from a connected USB flash drive.

Insert a USB flash drive in one of the **USB** connections on the TV while the TV is switched on.

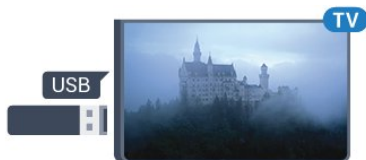

The TV detects the flash drive and opens a list showing its content.

If the contents list does not appear automatically, press **SOURCES** and select **USB**.

To stop watching the USB flash drive content, press **EXIT** or select another activity.

To disconnect the USB flash drive, you can pull out the flash drive anytime.

Ultra HD on USB

You can view photos in Ultra HD resolution from a connected USB device or flash drive. The TV will downscale the resolution to Ultra HD if the resolution of the photo is higher.

For more information on watching or playing content from a USB flash drive, in **Help**, press the colour key **Keywords** and look up **Photos, videos and music**.

4.14

Photo camera

To view photos stored on your digital photo camera, you can connect the camera directly to the TV.

Use one of the **USB** connections on the TV to connect. Switch on the camera after you made the connection.

If the contents list does not appear automatically, press **SOURCES**, and select **USB**.

Your camera might need to be set to transfer its content with PTP (Picture Transfer Protocol). Read the user manual of the digital photo camera.

For more information on viewing photos, in **Help**, press the colour key **Keywords** and look up **Photos, videos and music**.

4.15

Camcorder

HDMI

For best quality, use an HDMI cable to connect the camcorder to the TV.

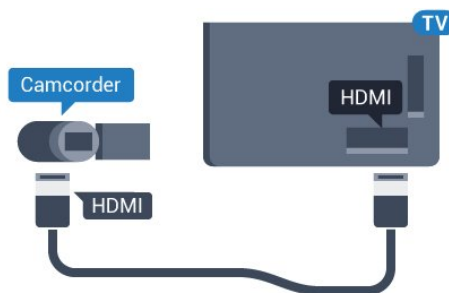

Audio Video LR / Scart

You can use an HDMI, YPbPr or SCART connection to connect your camcorder. If your camcorder only has Video (CVBS) and Audio L/R output, use a Video Audio L/R to SCART adapter (sold separately) to connect to the SCART connection.

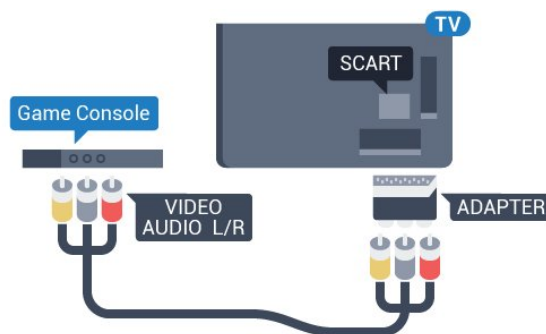

4.16

Computer

Connect

You can connect your computer to the TV and use the TV as a PC monitor.

With HDMI

Use an HDMI cable to connect the computer to the TV.

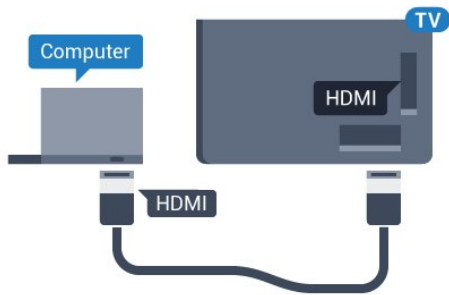

With DVI to HDMI

Alternatively, you can use a DVI to HDMI adapter (sold separately) to connect the PC to HDMI and an audio L/R cable (mini-jack 3.5mm) to AUDIO IN L/R on the back of the TV.

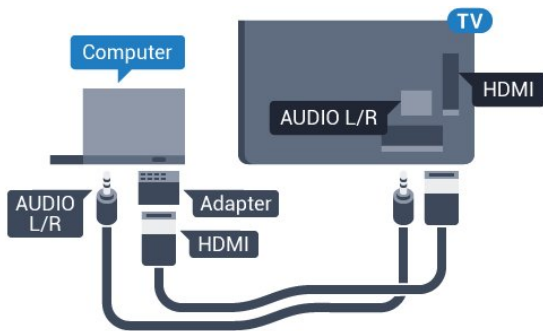

Ideal setting

If you connect a computer, we advise you to give the connection, on which the computer is connected, the correct device type name in the Source menu. If you then switch to **Computer** in the Source menu, the TV is set to the ideal Computer setting automatically.

You can manually switch the ideal setting to **Off** for watching TV or **Game** for playing a game from a connected game console (remember to switch back to **Off** when you stop playing a game).

If you switch to a source and change the **Game** or **Computer** setting, it will be stored for this selected source.

To set the TV to the ideal setting...

- 1 - Press **⚙**, select **Picture** and press **➤** (right) to enter the menu.
- 2 - Select **Advanced > Game or computer**, and press **OK**.
- 3 - Select **Game** (for gaming) or select **Computer** (for watching a movie).
- 4 - Press **◀** (left) repeatedly if necessary, to close the menu.

Remember to set **Game** or **computer** setting to **Off** when you stop playing the game.

Switching On and Off

On or standby

Before you switch on the TV, make sure you plugged in the mains power in the **POWER** connector on the back of the TV.



With the TV in Standby, press **⏻** on the remote control to switch the TV on. You can also press the small joystick key on the back of the TV to switch the TV on in case you can't find the remote control or its batteries are empty.

Switch to standby

To switch the TV to standby, press **⏻** on the remote control. You can also press the small joystick key on the back of the TV.

In standby mode, the TV is still connected to the mains power but consumes very little energy.

To switch off the TV completely, disconnect the power plug.

When disconnecting the power plug, always pull the power plug, never the cord. Ensure that you have full access to the power plug, power cord and outlet socket at all times.

Keys on TV

If you lost the remote control or its batteries are empty, you can still do some basic TV operations.

To open the basic menu...

- 1 - With the TV switched on, press the joystick key on the back of the TV to bring up the basic menu.
- 2 - Press left or right to select **🔊** Volume, **≡** Channel or **📺** Sources. Select **🎬** Demo, to start a demo movie.
- 3 - Press up or down to adjust the volume or tune to the next or previous channel. Press up or down to go through the list of sources, including the tuner selection. Press the joystick key to start the demo movie.
- 4 - The menu will disappear automatically.

To switch the TV on standby, select **⏻** and press the joystick key.



Sleep timer

With the **Sleep Timer**, you can set the TV to switch to Standby automatically after a preset time.

To set the Sleep Timer...

- 1 - Press **⚙️**, select **General settings > Sleep timer** and press **OK**.
- 2 - With the slider bar you can set the time to up to 180 minutes in increments of 5 minutes. If set to 0 minutes, the Sleep Timer is switched off. You can always switch off your TV earlier or reset the time during the countdown.
- 3 - Press **⬅️** **BACK** to close the menu.

Switch off timer

If the TV receives a TV signal but you don't press a key on the remote control during a 4 hour period, the TV switches off automatically to save energy. Also, if the TV does not receive a TV signal nor a remote control command for 10 minutes, the TV switches off automatically.

If you use the TV as a monitor or use a digital receiver to watch TV (a Set-Top Box - STB) and you do not use the remote control of the TV, you should deactivate this automatic switch off.

To deactivate the Switch Off Timer ...

- 1 - Press **⚙️**, select **Eco settings** and press **➤** (right) to enter the menu.
- 2 - Select **Switch off timer** and press **OK**.
- 3 - Press the arrows **⬆️** (up) or **⬇️** (down) to adjust the value. The value **0** deactivates the automatic switch off.
- 4 - Press **⬅️** (left) repeatedly if necessary, to close the menu.

For more information on environmentally friendly TV settings, in **Help**, press the colour key **—** **Keywords** and look up **Eco settings**.

Remote control

Key overview

Top

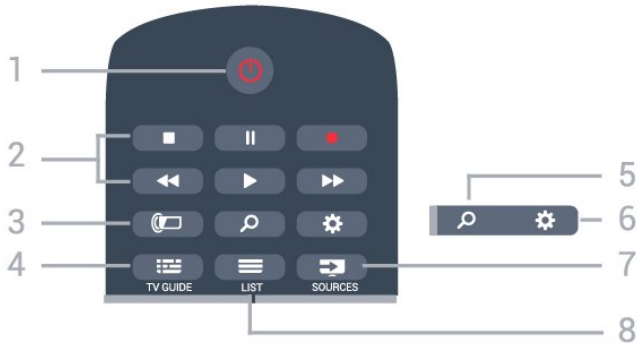

1 - Standby / On

To switch the TV on or back to Standby.

2 - Playback and Record

- Play , to playback.
- Pause , to pause playback
- Stop , to stop playback
- Rewind , to rewind
- Fast forward , to go fast forward
- Record , to start recording

3 - Ambilight

This function is only available in Ambilight series.

4 - TV GUIDE

To open or close the TV Guide.

5 - Search

To open the searches page.

6 - Settings

To open the Settings menu.

7 - SOURCES

To open the Sources menu.

8 - LIST

To open or close the channel list.

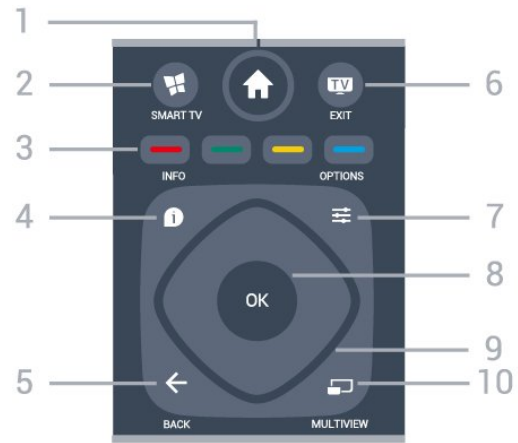

1 - Home

To open the Home menu.

2 - SMART TV

To open the Smart TV start page.

3 - Colour keys

Direct selection of options. Blue key , opens Help.

4 - INFO

To open or close programme info.

5 - BACK

To switch back to the previous channel you selected.

To close a menu without changing a setting.

To go back to the previous App/Internet page.

6 - - EXIT

To switch back to watch TV. To stop an interactive TV application.

7 - OPTIONS

To open or close the Options menu.

8 - OK key

To confirm a selection or setting. To open the channel list while watching TV.

9 - Arrow / navigation keys

To navigate up, down, left or right.

10 - MULTIVIEW

To open an extra small screen.

Bottom

Middle



- 1 - **NETFLIX**
To open the Netflix App directly. With the TV switched on or from standby.
- 2 - **Volume**
To adjust the volume level.
- 3 - **Number keys**
To select a channel directly.
- 4 - **SUBTITLE**
To switch subtitles on, off or to show automatically.
- 5 - **Channel**
To switch to the next or previous channel in the channel list. To open the next or previous page in Text/Teletext. To start the next or previous chapter on a disc.
- 6 - **Mute**
To mute the sound or to restore it.
- 7 - **TEXT**
To open or close Text/Teletext.

6.2

IR sensor

The TV can receive commands from a remote control that uses IR (infrared) to send commands. If you use such a remote control, always make sure you point the remote control at the infrared sensor on the front of the TV.

Warning

Do not put any objects in front of IR sensor of the TV, it may block the IR signal.

6.3

Batteries

If the TV does not react on a key press on the remote control, the batteries might be empty.

To replace the batteries, open the battery compartment on the back of the remote control.

- 1 - Slide the battery door in the direction shown by the arrow.
- 2 - Replace the old batteries with 2 type **AAA-R03-1.5V** batteries. Make sure the + and the - ends of the batteries line up correctly.
- 3 - Reposition the battery door and slide it back until it clicks.

Remove the batteries if you are not using the remote control for a long time.

Safely dispose of your old batteries according to the end of use directions.

For more information, in **Help**, press the colour key **Keywords** and look up **End of use**.

6.4

Cleaning

Your remote control is treated with a scratch-resistant coating.

To clean the remote control, use a soft damp cloth. Never use substances such as alcohol, chemicals or household cleaners on the remote control.

Channels

Install Channels

For more information, in **Help**, press the colour key **Keywords** and look up **Channel, Antenna installation** or **Channel, Cable installation**.

Switch channels

- To watch TV channels, press **TV**. The TV tunes to the TV channel you last watched.
- Alternatively, press **Home** to open the Home menu and select **Channels** and press **OK**.
- To switch channels, press **+** or **-**. If you know the channel number, type in the number with the number keys. Press **OK** after you entered the number to switch channels.
- To switch back to the previously tuned channel, press **BACK**.

To switch to a channel from a channel list

While watching a TV channel, press **LIST** to open the channel lists.

The channel list can have several pages with channels. To view the next or previous page, press **+** or **-**.

To close the channel lists without switching channels, press **LIST** again.

Radio channels

If digital broadcasting is available, digital radio stations are installed during installation. Switch to a radio channel just like you switch to a TV channel.

Channel lists

Favourite channels

You can create a favourite channel list that only holds the channels you want to watch. With the Favourite channel list selected, you will only see your favourite channels when you switch through channels.

Create your favourite channel list

- 1 - While watching a TV channel, press **LIST** to open the channel list.
- 2 - Select **All** to view all channels.
- 3 - Select the channel, and press **★** to mark as favourite.

- 4 - The selected channel is marked with a **★**.
- 5 - To finish, press **BACK**. The channels are added to the Favourites list.

To remove a channel from the favourites list, select the channel with **★**, then press **★** again to unmark as favourite.

Reorder

You can reorder — reposition — channels in the Favourite channel list.

- 1 - In the channel list **Favourites**, highlight the channel you want to reposition.
- 2 - Press **■**.
- 3 - Select the channel to reorder and press **OK**.
- 4 - Press the **Navigation buttons** to move the highlighted channel to another location and press **OK**.
- 5 - Once complete, press **TV EXIT** to exit from the Favourite channel list.

You can highlight another channel and do the same.

Channel list views

In the channel lists, you can find all installed TV and radio channels.

Next to the channel list **All**, which holds all installed channels, you can set up a list of **Favourites**, view the installed **Radio** stations separately or discover the newly added channels in **New**.

Channel logos

In some countries, the TV can show the channel logos. If you do not want these logos to appear, you can switch them off.

To switch off Channel logos . . .

- 1 - Press **⚙**, select **General settings** > **Channel logos** and press **OK**.
- 2 - Select **Off** and press **OK**.
- 3 - Press **BACK**, repeatedly if necessary, to close the menu.

Rename channels

You can rename channels in the channel list.

- 1 - Select the channel you want to rename in one of the channel lists.
- 2 - Select the channel to rename.
- 3 - Press **■**.

You can enter text with the remote control keyboard or open the on-screen keyboard.

With the on-screen keyboard

- To open the on-screen keyboard, place the cursor in the name text field and press **OK**.

- To delete the character in front of the cursor, press **Backspace**.
- To enter a character, select the character with the arrow keys and press **OK**.
- To select uppercase characters, press **Shift**.
- To select numbers or special characters, press **Shift**.
- When you are ready, press **← BACK** to close the on-screen keyboard.
- To finish renaming, select **Done** and press **OK**.

7.4

Watching channels

Tune to a channel

To start watching TV channels, press **TV**. The TV tunes to the channel you last watched.

Switch Channels

To switch channels, press **≡ +** or **≡ -**. If you know the channel number, type in the number with the number keys. Press **OK** after you entered the number to switch immediately.

Previous channel

To switch back to the previously tuned channel, press **← BACK**.

Lock a channel

Lock and unlock a channel

To prevent children from watching a channel, you can lock a channel. To watch a locked channel, you must enter the 4 digit **Child Lock** PIN code first. You cannot lock programmes from connected devices.

To lock a channel...

- 1 - Press **TV**.
- 2 - Press **OK** to open the channel list. If necessary change the channel list.
- 3 - Select the channel you want to lock.
- 4 - Press **≡ OPTIONS** and select **Lock channel** and press **OK**.
- 5 - Enter your 4 digit PIN code if the TV asks for it. A locked channel is marked with a **🔒** (lock).
- 6 - Press **←** (left) to go back one step or press **← BACK** to close the menu.

To unlock a channel...

- 1 - Press **TV**.
- 2 - Press **OK** to open the channel list. If necessary change the channel list.
- 3 - Select the channel you want to unlock.
- 4 - Press **≡ OPTIONS** and select **Unlock channel** and press **OK**.
- 5 - Enter your 4 digit PIN code if the TV asks for it.

- 6 - Press **←** (left) to go back one step or press **← BACK** to close the menu.

If you lock or unlock channels in a channel list, you only have to enter the PIN code just once until you close the channel list.

For more information, in **Help**, press the colour key **Keywords** and look up **Child lock** for more information.

Parental rating

To prevent children from watching a programme not suitable for their age, you can set an age rating.

Digital channels can have their programmes age rated. When the age rating of a programme is equal to or higher than the age you have set as age rating for your child, the programme will be locked. To watch a locked programme, you must enter the **Parental rating** code first.

To set an age rating...

- 1 - Press **⚙️**, select **Child Lock > Parental rating** and press **OK**.
- 2 - Enter a 4-digit Child lock code. If you did not set a code yet, select **Set code** in **Child lock**. Enter a 4-digit Child lock code and confirm. Now you can set an age rating.
- 3 - Back in **Parental rating**, select the age and press **OK**.
- 4 - Press **←** (left) repeatedly if necessary, to close the menu.

To switch off the parental age rating, select **None**. However, in some countries you must set an age rating.

For some broadcasters/operators, the TV only locks programmes with a higher rating. The parental age rating is set for all channels.

Channel options

Open options

While watching a channel, you can set some options.

Depending on the type of channel you are watching (analogue or digital) or depending on the TV settings you made, some options are available.

To open the options menu...

- 1 - While watching a channel, press **≡ OPTIONS**.
- 2 - Press **≡ OPTIONS** again to close.

Universal access

In **Help**, press **—** **Keywords** and look up **Universal access** for more information.

Video selection

Digital TV channels can offer multi video signals (multi-feed broadcast), different camera viewpoints or angles of the same event or different programmes on one TV channel. The TV shows a message if any such TV channels are available.

Subtitles

Switch on

To switch on Subtitles, press **SUBTITLE**.

You can switch subtitles **On** or **Off**. Alternatively you can select **Automatic**.

Automatic

If language information is part of the digital broadcast and the broadcasted programme is not in your language (the language set on TV), the TV can show subtitles automatically in one of your preferred subtitle languages. One of these subtitle languages must also be part of the broadcast.

You can select your preferred subtitle languages in **Subtitle language**.

Subtitles from Text

If you tune to an analogue channel, you need to make the subtitles available for each channel manually.

- 1 - Switch to a channel and press **TEXT** to open Text.
- 2 - Enter the page number for subtitles, usually **888**.
- 3 - Press **TEXT** again, to close Text.

If you select **On** in the Subtitle menu when watching this analogue channel, subtitles will be shown if available.

To know if a channel is analogue or digital, switch to the channel and press **i** **INFO**.

Subtitle Language

Preferred subtitle languages

A digital broadcast can offer several subtitle languages for a programme. You can set a preferred primary and secondary subtitle language. If subtitles in one of these languages are available, the TV will

show the subtitles you selected.

To set the primary and secondary subtitle language...

- 1 - Press **⚙**, select **General settings > Languages > Primary subtitles** or **Secondary subtitles**.
- 2 - Select the language you need and press **OK**.
- 3 - Press **⬅** (left) to go back one step or press **⬅** **BACK** to close the menu.

Select a subtitle language

If none of the preferred subtitle languages are available, you can select another subtitle language if available. If no subtitle languages are available, you cannot select this option.

To select a subtitle language when none of your preferred languages are available...

- 1 - Press **≡** **OPTIONS**.
- 2 - Select **Subtitle language** and select one of the languages as subtitles temporarily.

Audio language

Preferred audio language

A digital broadcast can offer several audio languages (spoken languages) for a programme. You can set a preferred primary and secondary audio language. If audio in one of these languages is available, the TV will switch to the audio language.

To set the primary and secondary audio language...

- 1 - Press **⚙**, select **General settings and select Languages > Primary audio** or **Secondary audio**.
- 2 - Select the language you need and press **OK**.
- 3 - Press **⬅** (left) to go back one step or press **⬅** **BACK** to close the menu.

Select an audio language

If none of the preferred audio languages are available, you can select another audio language if available. If no audio languages are available, you cannot select this option.

To select an audio language when none of your preferred languages are available...

- 1 - Press **≡** **OPTIONS**.
- 2 - Select **Audio language** and select one of the languages as audio temporarily.

Dual I-II

If an audio signal contains two audio languages but one language or both has no language indication, this option is available.

Common Interface

If you installed a CAM in one of the Common Interface slots, you can view the CAM and operator information or do some CAM related settings.

To view the CAM information...

- 1 - Press **SOURCES**.
- 2 - Select the channel type you are using the CAM for **Watch TV**.
- 3 - Press **OPTIONS** and select **Common Interface**.
- 4 - Select the appropriate Common Interface slot and press **>** (right).
- 5 - Select the TV operator of the CAM and press **OK**. The following screens come from the TV operator.

HbbTV on this channel

If you want to avoid access to HbbTV pages on a specific channel, you can block the HbbTV pages for this channel only.

- 1 - Tune to the channel of which you want to block the HbbTV pages.
- 2 - Press **OPTIONS** and select **HbbTV on this channel** and press **>** (right).
- 3 - Select **Off** and press **OK**.
- 4 - Press **<** (left) to go back one step or press **BACK** to close the menu.

To block HbbTV on TV completely...

- 1 - Press **Settings**, select **General settings > HbbTV**.
- 2 - Select **Off** and press **OK**.
- 3 - Press **<** (left) to go back one step or press **BACK** to close the menu.

MHP applications

Enable or disable the MHP applications.

Mono / Stereo

You can switch the sound of an analogue channel to Mono or Stereo.

To switch to Mono or Stereo...

- 1 - Tune to an analogue channel.
- 2 - Press **OPTIONS**, select **Mono/Stereo** and press **>** (right).
- 3 - Select **Mono** or **Stereo** and press **OK**.

4 - Press **<** (left) to go back one step or press **BACK** to close the menu.

Status

Select **Status** to view technical information on the channel (if it is analogue or digital) or a connected device you are watching.

Share

Enables the user to communicate his activity with his social networks (such as Twitter or email).

7.5

Text / Teletext

Text pages

To open Text/Teletext press **TEXT**, while you are watching TV channels.

To close Text, press **TEXT** again.

Select a Text page

To select a page . . .

- 1 - Enter the page number with the number keys.
- 2 - Use the arrow keys to navigate.
- 3 - Press a colour key to select a colour-coded subject at the bottom of the screen.

Text sub-pages

A Text page number can hold several subpages. The subpage numbers are shown on a bar next to the main page number.

To select a subpage, press **<** or **>**.

T.O.P. Text pages

Some broadcasters offer T.O.P. Text.

To open T.O.P. Text pages within Text, press **OPTIONS** and select **T.O.P. overview**.

Text options

In Text/Teletext, press **OPTIONS** to select the following...

- **Freeze page**
To stop the automatic rotation of subpages.
- **Dual screen / Full screen**
To show the TV channel and Text alongside each other.
- **T.O.P. overview**
To open T.O.P. Text.
- **Enlarge**
To enlarge the Text page for comfortable reading.

- **Reveal**

To unhide hidden information on a page.

- **Cycle subpages**

To cycle subpages when these are available.

- **Language**

To switch the group of characters that Text uses to display correctly.

- **Text 2.5**

To activate the Text 2.5 for more colours and better graphics.

Text setup

Text language

Some digital TV broadcasters have several Text languages available.

To set your primary and secondary Text language . . .

- 1 - Press , select **General settings** and press **➤** (right) to enter the menu.
- 2 - Select **Language** > **Primary text** or **Secondary text** and press **OK**.
- 3 - Select your preferred Text languages.
- 4 - Press **◀** (left) repeatedly if necessary, to close the menu.

Text 2.5

If available, Text 2.5 offers more colours and better graphics. Text 2.5 is activated as a standard factory setting.

To switch off Text 2.5...

- 1 - Press **TEXT**.
- 2 - With Text/Teletext open on screen, press  **OPTIONS**.
- 3 - Select **Text 2.5** > **Off**.
- 4 - Press **◀** (left) repeatedly if necessary, to close the menu.

7.6

Interactive TV

About iTV

With interactive TV, some digital broadcasters combine their normal TV programme with information or entertainment pages. On some pages, you can respond to a programme or vote, do online shopping or pay for a video-on-demand programme.

HbbTV, MHEG, . . .

Broadcasters use various interactive TV systems : HbbTV (Hybrid Broadcast Broadband TV) or iTV (Interactive TV - MHEG). Interactive TV is sometimes referred to as Digital Text or Red button. But each system is distinct.

Visit the broadcaster's Internet website for more

information.

What you need

Interactive TV is only available on digital TV channels. To enjoy the full benefits of Interactive TV, you need a high-speed (broadband) Internet connection to the TV.

HbbTV

If a TV channel offers HbbTV pages, you must first switch on HbbTV in the TV settings to view the pages.

- 1 - Press , select **General settings** > **Advanced** > **HbbTV** and press **OK**.
- 2 - Select **On**.
- 3 - Press **◀** (left) repeatedly if necessary, to close the menu.

If you want to avoid access to HbbTV pages on a specific channel, you can block the HbbTV pages for this channel only.

- 1 - Tune to the channel of which you want to block the HbbTV pages.
- 2 - Press  **OPTIONS** and select **HbbTV on this channel**.
- 3 - Select **Off**.

Use iTV

Open iTV pages

Most channels that offer HbbTV or iTV invite you to press the colour key  (red) or **OK** key to open their interactive programme.

Navigate iTV pages

You can use the arrow and colour keys, the number keys and the **◀** **BACK** key to navigate the iTV pages.

You can use the **▶** (Play), **⏸** (Pause) and **■** (Stop) keys to watch videos within iTV pages.

Digital Text (UK only)

To open Digital Text, press **TEXT**. To close, press **◀** **BACK** .

Close iTV pages

Most iTV pages inform you which key to use to close. To force an iTV page to close, switch to the next TV channel and press **◀** **BACK**.

About interactive TV

With interactive TV, some digital broadcasters combine their normal TV programme with information or entertainment pages.

Note:

- You cannot download files to your TV with this feature.
- Not all TV programmes, commercials and features include closed captioning information.
- You cannot respond to the digital content.

Visit the broadcaster's Internet website for more information.

TV Guide

8.1

What you need

With the TV Guide you can view a list of the current and scheduled TV programmes of your channels. Depending on where the TV guide information (data) is coming from, analogue and digital channels or only digital channels are shown. Not all channels offer TV Guide information.

The TV can collect TV Guide information for the channels that are installed on the TV. The TV cannot collect the TV Guide information for channels viewed from a digital receiver or decoder.

8.2

TV guide data

The TV Guide receives information (data) from broadcasters or from the Internet. In some regions and for some channels, TV Guide information might not be available. The TV can collect TV Guide information for the channels that are installed on the TV. The TV cannot collect the TV Guide information from channels viewed from a digital receiver or decoder.

The TV comes with the information set to **From the broadcaster**.

If TV Guide information comes from the Internet, the TV Guide can also list analogue channels next to the digital channels. The TV Guide menu also shows a small screen with the current channel.

From the Internet

If the TV is connected to the Internet, you can set the TV to receive the TV Guide information from the Internet.

To set the TV Guide information...

- 1 - Press , select **General Settings** and press **➤** (right) to enter the menu.
- 2 - Select **Advanced > TV Guide > From the Internet** and press **OK**.
- 3 - Press **◀** (left) repeatedly if necessary, to close the menu.

Missing recordings

When some recordings seem to have disappeared from the list of recordings, the TV Guide info (data) might have changed. Recordings made with the setting **From the broadcaster** become invisible in the list if you switch the setting to **From the Internet** or vice versa. The TV might have switched

to **From the Internet** automatically.

To make the recordings available in the list of recordings, switch to the setting that was selected when the recordings were made.

8.3

Using the TV guide

Open the TV guide

To open the TV Guide, press  **TV GUIDE**. The TV Guide shows the channels of the selected tuner.

Press  **TV GUIDE** again to close.

The first time you open the TV Guide, the TV scans all TV channels for programme information. This may take several minutes. TV Guide data is stored on TV.

Tune to a programme

From the TV Guide, you can tune to a current programme.

To switch to the programme (channel), select the programme and press **OK**.



View programme details

To call up the details of the selected programme...

- 1 - Press  **INFO**.
- 2 - Press  **BACK** to close.



Change day

The TV guide can show scheduled programmes for the upcoming days (maximum up to 8 days).



If the TV guide information comes from the broadcaster, you can press  **+** to view the schedule of one of the next days. Press  **-** to go back to the previous day.

Alternatively, you can press  **OPTIONS** and select **Change day**. Select **Previous day**, **Today** or **Next day** and press **OK**, to select the day of the schedule.

The TV guide can show scheduled programmes for the upcoming days (maximum up to 8 days).

If the TV guide information comes from the broadcaster, you can press  **+** to view the schedule of one of the next days. Press  **-** to go back to the previous day.



To change day...

- 1 - Press  **TV GUIDE**.
- 2 - Press  **OPTIONS**.
- 3 - Select **Change day**, select **Previous**

day, Today or Next day and press OK.
4 - Press ← BACK to close the menu.

Set a reminder



You can set reminders that alert you of the start of a programme with a message on screen.

- To set a reminder, select the programme in the schedule and press  for **Set reminder**. The programme is marked with a clock.
 - To cancel the reminder, press the  for **Clear reminder**.
 - To view a list of all reminders you have set, press  **OPTIONS**, and select **All reminders**.
-

Search by genre



If the information is available, you can look up scheduled programmes by genre like movies, sports, etc.

To search for programmes by genre...



- 1 - Press  **TV GUIDE**.
 - 2 - Press  **OPTIONS**.
 - 3 - Select **Search by genre** and press OK.
 - 4 - Select the genre you want and press OK. A list with the found programmes appears.
 - 5 - You can set reminders or schedule a recording on a selected programme.
 - 6 - Press ← **BACK** to close the menu.
-

Set a recording



You can set a recording in the TV Guide*.

To see the recording list, press  **Recordings**, a programme set to be recorded is marked with a  (red dot) on the front of the programme name.

To record a programme...

- 1 - Press  **TV GUIDE** and select a future or ongoing programme.
- 2 - Press the colour key  **Record**.
- 3 - Press ← **BACK** to close the menu.

To cancel a recording...

- 1 - Press  **TV GUIDE** and select the programme set for recording.
- 2 - Press the colour key  **Clear Recording**.
- 3 - Press ← **BACK** to close the menu.

Recording and Pause TV

Recording

What you need

You can record a digital TV broadcast and watch it later.

To record a TV programme you need...

- a connected USB Hard Drive formatted on this TV
- digital TV channels installed on this TV
- to receive channel information for the on screen TV Guide
- a reliable TV clock setting. If you reset the TV clock manually, recordings may fail.

You cannot record when you are using Pause TV.

Some digital TV operators do not allow the recording of channels.

For more information on installing a USB Hard Drive, in **Help**, press the colour key **Red** **Keywords** and look up **USB hard drive, installation**.

Record a programme

Record now

To record the programme you are watching right now, press **Red** (Record) on the remote control. The recording will start immediately.

To stop the recording, press **Black** (Stop).

When TV Guide data is available, the programme you are watching will be recorded from the moment you pressed the recording key until the programme ends.

- If you receive TV guide information from the Internet, you can adjust the end time of the recording in the pop-up window before you confirm the recording.
- If you receive TV guide information from the broadcaster, the recording starts immediately. You can adjust the end time of the recording in the list of recordings.

Schedule a recording

You can schedule a recording of an upcoming programme for today or a few days from today (maximum of 8 days away).

1 - To schedule a recording, press **TV Guide**. On the TV guide page, select the channel and programme you wish to record.

You can enter the channel number to jump to the channel in the list.

Press **Right** or **Left** to scroll through the programmes of a channel.

To change the date of the list, press **Options** and select **Change day**. In the list, select the day you want and press **OK**. If the TV guide comes from the Internet, you can select the date at the top of the page and press **OK**.

2 - With the programme highlighted, press **Record**. The TV adds some time buffer at the end of the programme. You can add some extra buffer if needed.

3 - Select **Schedule** and press **OK**. The programme is scheduled for recording. A warning will appear / will be shown automatically when overlapping recordings are scheduled.

If you plan to record a programme in your absence, remember to leave the TV switched to standby and the USB Hard Drive switched on.

List of recordings

To view the list of recordings and scheduled recordings, press **Home**, select **Utilities** > **Recordings** and press **OK**.

In this list, you can select a recording to watch, remove recorded programmes, adjust the end time of an ongoing recording or check the free disk space. Also in this list, if the TV guide comes from the Internet, you can schedule a recording for which you set the beginning and end time yourself, as a timed recording not linked to a programme. To set a timed recording, select **Schedule recording** at the top of the page and press **OK**. Set the channel, date and time span. To confirm the recording, select **Schedule** and press **OK**.

Remove a scheduled recording

Select the scheduled recording, press **Remove** and press **OK**.

Specifics

- While recording a programme, you can watch a previously recorded programme.
- While recording, you cannot switch TV channels.
- While recording, you cannot pause the TV broadcast.
- To Record, broadcasters need a reliable clock setting. If you reset the TV clock manually, recordings may fail.
- The Audio Description audio (commentary) for the visually impaired cannot be recorded.

• You can record the digital (DVB) subtitles of channel. You cannot record subtitles that come from Text services. To check if digital (DVB) subtitles are available, tune to the TV channel and press **≡** **OPTIONS**, select **Subtitle language** to open the list of Subtitles. You can only record a subtitle language preceded by a **DVB** icon.

Watch a recording

To watch a recording . . .

1 - Press **↑** **Home**, select **Utilities** > **Recordings** and press **OK**.
2 - In the list, select the recording and press **▶** (Play) to start the playback. You can use the **▶▶** (Forward), **◀◀** (Rewind), **||** (Pause) or **■** (Stop) keys on the remote control.

Expired recording

Broadcasters can limit the number of days a recording can be viewed. A recording in the list can show the number of days before it expires.

Failed recording

When a scheduled recording was prevented by the broadcaster or when the broadcast was interrupted, a recording is marked as **Failed**.

Delete a recording

To delete a made recording, select the recording in the list, press **■** **Remove** and press **OK**.

For more information, press **■** **Keywords** and look up **Record a programme**.

9.2

Pause TV

You can pause a TV broadcast and resume watching it later. Only digital TV channels can be paused. You must connect a USB Hard Drive to buffer the broadcast. You can pause a broadcast for a maximum time span of 90 minutes.

For more information, press **■** **Keywords** and look up **USB hard drive**.

Pause or resume a broadcast

To pause a broadcast, press **||** (Pause). A progress bar appears briefly on screen.

To call up the progress bar, press **||** (Pause) again.

To resume watching, press **▶** (Play). The icon on screen indicates you are watching a paused broadcast.

Back to the actual TV broadcast

To switch back to the actual TV broadcast, press **■** (Stop).

The moment you switch to a digital channel, the USB Hard Drive starts buffering the broadcast. When you switch to another digital channel, the broadcast of the new channel is buffered and the broadcast of the former channel is cleared. When you switch to a connected device (a Blu-ray Disc player or digital receiver) the USB Hard Drive stops buffering and the broadcast is cleared. Also when you switch the TV to standby the broadcast is cleared.

Whilst recording a programme on the USB Hard Drive, you cannot pause a broadcast.

Instant replay

Whilst watching a broadcast from a digital TV channel, you can easily instant replay the broadcast. To replay the last 10 seconds of a broadcast, press **||** (Pause) and press **◀** (Left). You can press **◀** repeatedly until you reach the start of the broadcast buffer or the maximum time span.

Progress bar

With the progress bar on screen, press **◀◀** (Rewind) or press **▶▶** (Forward) to select from where you want to start viewing the paused broadcast. Press these keys repeatedly to change speed.

Home menu

About the Home menu

Channels

This row contains all channels.

Sources

This row contains available sources in this TV.

Utilities

This row contains TV functions which are available for user.

Quick settings

This row contains settings which are available for user.

Open the Home menu

To open the Home menu and open an item...

- 1 - Press **⬆️** Home .
- 2 - Select an item and press **OK** to open or start it.
- 3 - Press **⬅️** BACK to close the Home menu without starting anything.

Utilities

Smart TV

Open Smart TV page.

Internet

Open Internet browser.

TV guide

For more information, in **Help**, press the colour key **— Keywords** and look up **TV guide**.

Recording

For more information, in **Help**, press the colour key **— Keywords** and look up **Recording**.

Channel

View channel list.

Update software

For more information, in **Help**, press the colour key **— Keywords** and look up **Update software**.

Demo Me

View Demo Me for demo on this TV.

Browse Net TV

View available Net TV content.

BBC Catal

View BBC Catal content.

BBC News

View BBC news content.

BBC iPlayer

View BBC iPlayer content.

BBC Sport

View BBC sport content.

Netflix

If you have a Netflix membership subscription, you can enjoy Netflix on this TV. Your TV must be connected to the Internet.

To open Netflix, press **NETFLIX** to open the Netflix App. You can open Netflix immediately from a TV in standby.

www.netflix.com



Sources

13.1

Switch to a device

From the list of Sources, you can switch to any of the connected devices. You can switch to a tuner to watch TV, open the content of a connected USB Flash Drive or see the recordings you made on a connected USB Hard Drive. You can switch to your connected devices to watch their programme, a digital receiver or a Blu-ray Disc player.

To switch to a connected device...

- 1 - Press  SOURCES to open the Sources menu.
- 2 - Select one of the item in the source list and press **OK**. The TV will show the programme or content of the device.
- 3 - Press  SOURCES again to close the menu.

One Touch Play

With the TV in standby, you can switch on a disc player with your TV remote control.



To switch on both disc player and TV from standby and start playing the disc immediately, press  (play) on the TV remote control. The device must be connected with an HDMI cable and both TV and device must have HDMI CEC switched on.

13.2

Options for a TV Input

Some TV input devices offer specific settings.

To set the options for a specific TV input...

- 1 - Press  SOURCES.
- 2 - Select the TV input in the list and press **OK**.
- 3 - Press  OPTIONS. You can set the options for the selected TV input here.
- 4 - Press  OPTIONS again to close the Options menu.

Possible options...



Controls

With this option you can operate the connected device with the TV remote control. The device must be connected with an HDMI cable and both TV and device must have HDMI CEC switched on.

Device Info

Open this option to view information on the connected device.

Scan connections

To rescan connections and update the Sources menu, press  Scan connections. (if  key is available on the bottom of the screen.)

13.4



Game or computer

The device type determines picture and sound styles, resolution values and other specifics. You don't have to worry about the ideal settings.

For some devices the type of the device is not that clear. A game console can have a built-in Blu-ray Disc player and the type is set to Player because it is used as a disc player most of the time. For this kind of devices, you can temporarily switch to the ideal settings for gaming. Or alternatively, switch to the ideal settings for a connected computer.

You can only use the setting **Game or Computer** when you switch to a connected device in the Sources menu. The Game or Computer setting is stored for the selected device.

To switch to the ideal settings for gaming or computer manually...

- 1 - Press , select **Picture > Advanced** and press **OK**.
- 2 - Select **Game, Computer** or **Off**.
- 3 - Press  (left) to go back one step or press  BACK to close the menu.

Remember to set this setting back to **Off** when you stop playing the game.

Internet





14.1

Start Internet

You can browse the Internet on your TV. You can view any Internet website but most of them are not prepared for a TV screen.

- Some plug-ins (e.g. to view pages or videos) are not available on your TV.
- You cannot send or download files.
- Internet pages are shown one page at a time and full screen.

To start the Internet browser...

- 1 - Press  Home > Utilities, and press OK.
- 2 - Select  Internet and press OK.
- 3 - Enter an Internet address and press OK.
- 4 - To close Internet, press  Home or  EXIT.

Videos, photos and music





15.1

From a USB connection

You can view your photos or play your music and videos from a connected USB flash drive or USB Hard Drive.

With the TV switched on, plug in a USB flash drive or a USB Hard Drive to one of the USB connections. The TV detects the device and will list your media files.

If the list of files does not appear automatically...

- 1 - Press  SOURCES, select  USB and press OK.
- 2 - Select  USB Devices and press  (right) to select the USB device you need.
- 3 - You can browse your files in the folder structure you have organised on the drive.
- 4 - To stop playing videos, photos and music, press  EXIT.

Warning

If you try to pause or record a programme with a USB Hard Drive connected, the TV will ask you to format the USB Hard Drive. This formatting will delete all current files on the USB Hard Drive.

15.2

From a computer

If the TV and the computer are in the same network, the TV can browse and play files stored on your computer.

On your computer, you need to install media server software like Twonky™ to share your files with the TV. The TV shows your files and folders as they are organised on your computer.

To browse the files on your computer, press  SOURCES, select **Browse network** and press OK.

15.3





Menu bar and sorting

With a USB device connected, the TV sorts the files by type. Navigate to the menu bar and select the type of file you are looking for.

If you browse files from a computer, you can only browse the files and folders as they are organized on the computer.

The menu bar

Navigate to the menu bar and select the type of file you want to watch or play.

Select  Photos,  Music or  Videos. Alternatively, you can open the  Folders view and browse your folders to look for a file.

Sorting

To browse your photos by date, month, year or alphabetically by name, press .









To browse your music by album, artist, genre or alphabetically by name, press .

Videos are sorted alphabetically.

15.4

Play your videos

Play videos

- To play a video, select  Videos in the menu bar, select a video and press OK.
- If there are more videos in the same folder, press  Play all to play all videos in this folder.
- To jump to the next or previous video, press  + or  -.
- To pause the video, press OK. Press OK again to continue.
- To make a 10-second jump forward or backward in a video, press  or .
- To rewind or go fast forward, press  or . Press the keys several times to speed up - 2x, 4x, 8x, 16x, 32x.
- To stop the video playback, press  (Stop).

Info

To view info on a video (playhead position, duration, title, date, etc.), select the video and press  INFO. Press again to hide the info.





Video options

During the video playback, press  OPTIONS to...

- **Subtitles** – If available, you can switch subtitles **On**, **Off** or **On During Mute**.
- **Shuffle** – Play your files in a random order.
- **Repeat** – Plays all videos in this folder once or continuously.

View your photos

View photos

To view photos, select  **Photos** in the menu bar, select a photo thumbnail and press **OK**.
 If there are several photos in the same folder, select a photo and press  **Slide show** to start a slide show of all photos in this folder.
 To jump to the next or previous photo, press  + or  - .
 To stop the slide show or close the photo, press  (Stop).

Info

To view info on a photo (size, creation date, file path, etc.), select a photo and press  **INFO** .
 Press again to hide the info.

Slideshow with music

You can watch a slideshow of your photos and listen to your music at the same time. You must start the music before you start the photo slideshow.

To play music with the slide show...





- 1 - Select a song or a folder with songs and press **OK**.
- 2 - Press  **INFO** to hide the browser list.
- 3 - Press  **BACK** .
- 4 - Now use the navigation arrows to select the folder with photos.
- 5 - Select the folder with photos and press  **Play All**.
- 6 - To stop the slideshow, press  **BACK** .









Photo options

With a photo on screen, press  **OPTIONS** to...

- **Shuffle** – Play your files in a random order.
- **Repeat** – Play the slide show once or continuously.
- **Slide show speed** – Set the speed of the slide show.
- **Slide show transition** – Set the style of the photo transitions.

Play your music

Play music

- To play music, select  **Music** in the menu bar, select a song and press **OK**.
- If there are more songs in the same folder, press  **Play all** to play all songs in this folder.
- To jump to the next or previous song, press  + or  - .
- To pause the music, press **OK**. Press **OK** again to continue.
- To make a 10-second jump in a song or 10-second jump back, press  or .
- To rewind or fast forward, press  or . Press the keys several times to speed up - 2x, 4x, 8x, 16x, 32x.
- To stop the music playback, press  (Stop).

Info

To view song info (title, artist, duration, etc.), select the song and press  **INFO** .
 Press again to hide the info.

Music options

Options for playing music...

- **Shuffle** – Play your files in a random order.
- **Repeat** – Plays all songs in this folder once or continuously.

Smartphones and tablets

Philips TV Remote App

The new Philips TV Remote App on your smartphone or tablet is your new TV buddy.

With the TV Remote App, you master your media around you. Send photos, music or videos to your big TV screen or watch any of your TV channels live on your tablet or phone. Look up what you want to watch on the TV Guide and watch it on your phone or TV. With the TV Remote App you can use your phone as a remote control.

Download the Philips TV Remote App from your favourite app store today.

The Philips TV Remote App is available for iOS and Android and is free of charge.

Wi-Fi Smart Screen

To watch digital TV channels on your smartphone or tablet with the Philips TV Remote App, you must switch on Wi-Fi Smart Screen. For more information, in **Help**, press the colour key **— Keywords** and look up **Wi-Fi smart screen**.

Miracast

About Wi-Fi Miracast

You can view your photos or play your music and videos from a mobile device on your TV with Wi-Fi Miracast™. The mobile device and the TV should be within range, which usually means being in the same room.

Check if your mobile device is ready for Miracast.

Your TV is a **Wi-Fi CERTIFIED Miracast™** device. With Miracast™, you can watch and share the screen of your smartphone, tablet or computer on your TV screen wirelessly. You can stream videos (audio and video), share photos or anything else that's on screen of the device. No need to connect the device to your home network. Both the TV and the device must be Wi-Fi CERTIFIED Miracast™ devices and have Miracast switched on.

Miracast on this TV is subject to the HDCP protocol and cannot display copy-protected premium content sent by a device. The maximum video resolution supported is 720p for 2.4GHz Wi-Fi or 1080p for 5GHz

Wi-Fi.

For more information on Wi-Fi CERTIFIED Miracast™ go to www.wi-fi.org

Wi-Fi®, the Wi-Fi CERTIFIED logo, the Wi-Fi logo are registered trademarks of the Wi-Fi Alliance. **Wi-Fi CERTIFIED Miracast™**, **Miracast™** are trademarks of the Wi-Fi Alliance.

Switch on Miracast

Make sure Wi-Fi Miracast is switched on.

- 1 - Press **⚙**, select **Network** and press **▶ (right)** to enter the menu.
- 2 - Select **Wi-Fi Miracast** and press **OK**.
- 3 - Select **On** and press **OK**.
- 4 - Press **◀ (left)** repeatedly if necessary, to close the menu.

Share a screen on TV

To share the screen of your smartphone, tablet or computer on the TV...

- 1 - Switch on the TV.
- 2 - On the device, in the settings menu, set the device to cast or mirror its display. Miracast uses Wi-Fi Direct™.
- 3 - On the device scan for the available Miracast devices and select the TV to connect.
- 4 - On the TV, agree to the request to connect. You might be asked to enter a PIN code from the device on the TV - enter the numbers with the digit keys on the remote control. Alternatively, you might be asked to enter a PIN code on the device. If the connection is made, the TV will show the screen of the device.
- 5 - On the device, select the videos, photos or files you want to watch on TV.

* Miracast is supported by WiDi 3.5 onwards.

You might find the Wi-Fi connection (e.g. 'DIRECT_tvname') also in lists of available networks on other network devices, e.g. your laptop computer. However, this connection can only be used by Wi-Fi Miracast devices.

Stop sharing

You can stop sharing a screen from the TV or from the mobile device.

From the device

With the application you use to start Miracast, you can disconnect and stop watching the screen of the device on TV. The TV will switch back to the last selected programme.

From the TV

To stop watching the screen of the device on TV, you can . . .

- press **TV** EXIT to watch a TV broadcast
- press **Home** to start another activity on TV
- press **SOURCES** to open the Sources menu and select a connected device.

Block a device

The first time you receive a request to connect from a device, you can block the device. The request from this device and all its requests in the future, will be ignored.

To block a device...

Select **Block...** and press **OK**.

Unblock all devices

All previously connected and also blocked devices are stored in the Wi-Fi Miracast list of connections. If you clear this list, all blocked devices will be unblocked.

To unblock all blocked devices...

- 1 - Press **Settings**, select **Network** and press **OK**.
- 2 - Select **Reset Wi-Fi Miracast connections** and press **OK**. The list is cleared.
- 3 - Press **Left** repeatedly if necessary, to close the menu.

Blocking a previously connected device

If you want to block a device that you previously connected, you need to clear the Wi-Fi Miracast connections list first. If you clear this list, you will have to confirm or block the connection for every device again.

Screen delay

The normal delay when sharing a screen with Miracast is about 1 second. The delay might be longer if you are using older devices with less processing power.

16.3

MHL

This TV is MHL™ compliant.

If your mobile device is also MHL compliant, you can connect your mobile device with a MHL cable to the TV. With the MHL cable connected you can share what's on your mobile device on the TV screen. Your mobile device charges its battery at the same time.

The MHL connection is ideal for watching movies or playing games from your mobile device on TV for a longer time.

Charging

With the MHL cable connected, your device will charge while the TV is switched on (not in standby).

MHL Cable

You need a passive MHL cable (HDMI to Micro USB) to connect your mobile device to the TV. You might need an extra adapter to connect to your mobile device. To connect the MHL cable to the TV use the **HDMI 4 MHL** connection.



MHL, Mobile High-Definition Link and the MHL Logo are trademarks or registered trademarks of the MHL, LLC.

In **Help**, press **Keywords** and look up **HDMI MHL** for more information.

16.4

Smart TV

About Smart TV

Connect this TV to the Internet and discover a new world of television. You can make a wired connection to your router or you can link up wirelessly with Wi-Fi.

With the TV connected to your home network, a smartphone can show a photo on TV, you can play videos stored on your computer or control the TV with your tablet.

With your TV connected to the Internet, you can watch a rental video from an online video store, read the online TV guide or record your favourite TV show on a USB Hard Drive. The Smart TV Apps add to the fun with all sorts of entertainment and convenient services.

What you need

To enjoy **Smart TV Apps** you must connect the TV to a router with a high-speed (broadband) connection to the Internet. You can use a home network connected to the Internet. You do not need a computer.

For more information, press **Keywords** and look up **Network**.

Tip

To enter text or to navigate an Internet page more easily, you can consider to connect a USB keyboard and a USB mouse to the TV.

For more information, press **— Keywords** and look up **USB keyboard** or **USB mouse**.

Setup Smart TV

The first time you open Smart TV, you need to configure your connection. Read and agree to the terms and conditions to continue. If you do not want to set up Smart TV, press **← BACK**.

Parental control

To lock Adult 18+ rated apps . . .

- 1 - Switch on Smart TV parental control by selecting **Enable** and then press **OK**.
- 2 - Enter an unlock PIN code of your choice.
- 3 - Confirm your PIN code.

Adult 18+ rated apps are now locked. To open a locked app, select the app and press **OK**. The TV will ask you to enter your 4-digit code.

Smart TV Apps

Open Smart TV

The Smart TV start page is your link to the Internet. You can rent movies online, read newspapers, watch videos and listen to music, also shop online, or watch TV programmes when it suits you with Online TV.

To do this, you open Apps - Internet sites which are tailored for TV. With your TV connected to the Internet, you can open Smart TV.

Open Smart TV

To open the Smart TV start page, press **Smart TV** . Alternatively, you can press **Home** > **Utilities**, select **Smart TV** and press **OK**.

The TV connects to the Internet and opens the Smart TV start page. This may take a few seconds.

Close Smart TV

To close the Smart TV start page, press **Home** and select another activity.

TP Vision Europe B.V. bears no responsibility regarding the content and the quality of the content provided by the content service providers.

Smart TV start page

- 1 - Now on your TV
- 2 - Your Apps
- 3 - App gallery
- 4 - Internet
- 5 - Recommended Apps
- 6 - Search
- 7 - Colour keys for control

Your Apps

You start Apps from the Smart TV start page. If the start page does not hold any Apps yet, you can add Apps from the App gallery.

App gallery

In the App gallery you find all available Apps.

Internet

The Internet App opens the World Wide Web on your TV.

On your TV, you can view any Internet website but most of them are not tailored for a TV screen.

- Some plug-ins (e.g. to view pages or videos) are not available on your TV.

- Internet pages are shown one page at a time and full screen.

Recommended Apps

In this window, Philips presents a range of recommended Apps for your country, Apps for Online TV or a selection of rental movies from Video stores. You can select and open them from the Recommended Apps window.

Search

With Search, you can search the App gallery for relevant Apps.

Enter a keyword in the text field, select **🔍** and press **OK** to start searching. You can enter names, titles, genres and description keywords to search. Alternatively, you can leave the text field empty and search for the most popular searches/keywords for a range of categories. In the list of found keywords, select a keyword and press **OK** to search for items with that keyword.

Open an App

To open an App, you must add it to your list of Apps in the Smart TV start page first. You can add Apps to your list from the App gallery.

The list of your Apps on the Smart TV start page can be several pages long. Use the arrow keys to go to the next or previous page. Alternatively, press **⏮ +** (Next page) or **⏭ -** (Previous page).

Open an App

To open an App . . .

1 - Press **Home** > **Utilities** > **Smart TV** .

2 - On the start page, select an App icon and press **OK**.

In an App, press **BACK** to go back 1 step or page.

Close an App

To close an App and return to the Smart TV start page, press **Smart TV** .

Reload an App page

If an App page did not load properly, press **OPTIONS** and select **Reload** to reload the page.

Zoom

To zoom in on an App page . . .

1 - Press **OPTIONS** and select **Zoom page**.

2 - Use the slider bar to set the zoom level.

3 - Return to normal view by resetting the slider bar.

View security info

You can check the security level of an App page.

On an App page, press **OPTIONS** and select **Security info**. If a lock  is shown next to the loading animation on the bottom of the screen while loading a page, the transfer is secured.

Feedback on an App

Select the App and press **Feedback** to select a 'like' or 'don't like' button and send a suggestion or remark to us. You can also report an App malfunction.

Manage your Apps

In the list of Apps on the Smart TV start page you can . . .

• Remove an App

To remove an App from the list, select the App icon and press **Remove** . The App is still available in the App gallery.

• Move an App

To reposition an App in the list, select the App icon, press **Move** and use the arrow keys to reposition the App. Press **OK** to confirm the position.

• Lock an App

To lock an App, select the App icon and press **Lock** .

When you lock an App, you must enter the 4 digit PIN code you set for Parental control when you configured Smart TV. In the list, a locked App is marked with a lock .

To unlock an App, select the App icon and press **Unlock** . You must enter the 4 digit PIN code to unlock.

App gallery

Open the **App gallery** in Smart TV to browse the Apps, the collection of tailored websites for TV.

Find the App for YouTube videos, a national newspaper, an online photo album, etc. There are Apps to rent a video from an online video store and Apps for watching programmes you missed. If the App gallery does not hold what you are looking for, try the World Wide Web and surf the Internet on TV.

Rental video Apps

With the video store Apps in Smart TV, you can rent your favourite movie from an online rental video store. You can pay securely with your credit card.

Rent a movie

1 - Open a Video store App in your list of Apps or select a recommended video on the Smart TV start page.

2 - Select a movie.

3 - Make the online payment.

4 - Start watching. You can use the **Play** and **Pause** keys.

Most Video stores ask you to create a login account.

Streaming video

With this TV, you can watch rental movies sent as a streaming video format. You can almost instantly watch the movie. You might need a USB Hard Drive to store some video buffer. If you have a USB Hard Drive connected, you can also download rental movies from video stores that offer movie downloading only. You can pause or restart a downloaded rental movie. Consult the video store regarding the rental duration of rental movies.

Internet traffic

Streaming or downloading many videos may exceed your monthly Internet traffic limit.

Online TV

With the Online TV App on the Smart TV start page*, you can watch TV programmes you missed or watch programmes whenever it suits you best.

Open Online TV

To open the Online TV App . . .

1 - Press **Smart TV** .

2 - On the start page, select the  **Online TV** icon and press **OK**.

3 - Select a programme on the page and press **OK** to start watching. You can use the **Play** and **Pause** keys.

List per broadcaster

To view the Online TV programmes ordered by broadcaster, press **→ All broadcasters** .
Select a broadcaster and press **OK**.

* If available in your region.

Multi View

While you are on a Smart TV App or the Internet, you can watch the current TV channel. **Multi view** opens a small screen for the TV channel next to the Smart TV screen.

To open Multi view...

- 1 - Press **SMART TV** to open Smart TV.
- 2 - Press **MULTI VIEW** to open the small screen.
- 3 - Press **≡ +** or **≡ -** to change the TV channel in the small screen.

Reset Smart TV

To reset your connection with Smart TV, clear the Internet memory on the TV.
You will clear your Philips Smart TV registration and parental rating setting, your video store app logins, all Smart TV app favourites, Internet bookmarks and history.

To clear the Internet memory...

- 1 - Press **⚙**, select **Network** and press **➤** (right) to enter the menu.
- 2 - Select **Clear Internet memory** and press **OK**.
- 3 - Select **OK** to confirm.
- 4 - Press **◀** (left) repeatedly if necessary, to close the menu.

Multi room

17.1

About Multi room

With Multi Room you can watch a TV programme that comes from another TV in your home. The programme is streamed from one TV to the other. You can stream a programme to a TV that has no antenna connection or has no Smart card subscription of its own. You can also stream a recorded programme from a TV with a connected Hard Drive.

The TV that streams the programme to the other TV, must be switched on and must tune to the channel or play the recording.

Streaming a TV programme with Multi Room will reduce the picture resolution to 720p maximum. You cannot stream radio channels. Some broadcasters protect their programmes to prevent this kind of streaming.

17.2

What you need

To stream a TV programme from one TV to another, the programme must come from a digital TV channel.

Both TVs must be connected to your wireless home network. For more information, press **Keywords** and look up **Wireless Network**.

Also, both TVs must have a Philips model number that ends with an 8 or higher - e.g. xxXXXxxx8. It might be necessary to update the older TV with its latest software. On the older TV, read the Help chapter on updating software.

Make sure that both TVs have the setting **Switch on with Wi-Fi (WoWLAN)** switched on in the TV setup.

To check this setting on this TV...

- 1 - Press **Settings**, select **Network** and press **Right** to enter the menu.
- 2 - Select **Switch on with Wi-Fi (WoWLAN)** and press **OK**.
- 3 - Select **On** and press **OK**.
- 4 - Press **Left** repeatedly if necessary, to close the menu.

Using Multi room

First time use

When you start Multi room for the first time, switch on both TVs.

Once this TV made a connection with the other TV, the other one will appear automatically in the **Browse network** menu even when it's in standby.

Stream a TV channel

With Multi room, you can watch the current TV channel or open the channel list of the other TV. If you select a channel from the list, the other TV will also switch to the channel you selected. If the other TV has a build-in satellite tuner with installed channels or a connected Hard Disc Drive (HDD) with recordings*, you can also watch these on this TV. You cannot switch channels while the other TV is recording, in Pause TV mode or using Skype.

To watch a TV channel from the other TV . . .



- 1 - Make sure the other TV is in standby* or switched on.
- 2 - On this TV, press **SOURCES**, select **Browse network** and press **OK**.
- 3 - If the TV is not yet connected to your home network, the network installation will start automatically. If the TV is already connected, go to step 4.
- 4 - In the **Browse network** menu, select the name of the other TV and press **OK**. If you have several TVs in your home, you might want to change the name of the other TV. You can do that on the TV itself.
- 5 - Select what you want to watch from the other TV . . .
 - to watch the current channel of the other TV, select **Current channel** and press **OK**.
 - to open the channel list of the other TV, select **Watch TV** and press **Right**.
 - to open the satellite channel list of the other TV, select **Watch satellite** and press **Right**.
 - to open the list of recordings* on the other TV, select **Watch recordings** and press **Right**.
 - you can switch channels with **+** and **-**. You cannot switch channels when the other TV is recording, in Pause TV mode or using Skype.

* To switch on the other TV from standby or to watch its recordings from a connected HDD, both TVs must have a type number that ends with an 8 or higher - e.g. xxXXXxxx8 or xxXXXxxx9.

TV network name

If you have more than one TV in your home network, you can give the TV a unique name.

To change the TV name...

- 1 - Press , select **Network** and press  (right) to enter the menu.
- 2 - Select **TV network name** and press **OK**.
- 3 - Enter the name with the on-screen keyboard.
- 4 - Select **Done** to confirm the change.
- 5 - Press  (left) repeatedly if necessary, to close the menu.

Settings

Quick settings

Eco settings

For more information, in **Help**, press the colour key **— Keywords** and look up **Eco settings**.

Picture style

For more information, in **Help**, press the colour key **— Keywords** and look up **Picture style**.

Picture format

For more information, in **Help**, press the colour key **— Keywords** and look up **Picture format**.

Sound style

For more information, in **Help**, press the colour key **— Keywords** and look up **Sound style**.

Headphones volume

For more information, in **Help**, press the colour key **— Keywords** and look up **Headphones volume**.

Speakers

For more information, in **Help**, press the colour key **— Keywords** and look up **TV speakers**.

Clock

For more information, in **Help**, press the colour key **— Keywords** and look up **Clock**.

Sleep timer

For more information, in **Help**, press the colour key **— Keywords** and look up **Sleep timer**.

Picture

Picture style

Select a style

For easy picture adjustment, you can select a preset Picture Style.

- 1 - While watching a TV channel, press **⚙**.
- 2 - Select **Picture > Picture style**, and select one of the styles in the list.
- 3 - Press **◀** (left) repeatedly if necessary, to close the menu.

The available styles are...

- **Personal** - The picture preferences you set during the first start up.
- **Vivid** - Ideal for daylight viewing
- **Natural** - Natural picture settings
- **Standard** - Most energy conscious setting - Factory setting
- **Movie** - Ideal for watching movies
- **Photo** - Ideal for viewing photos

Customise a style

Any picture setting you adjust, like Colour or Contrast, is stored in the currently selected **Picture style**. It allows you to customise each style.

Only the style **Personal** can save its settings for each connected device in the Sources menu.

Restore a style

The selected style will store the changes you made. We recommend to adjust the picture settings for the style **Personal** only. The Picture Style - Personal can save its settings for each individual connected device in Sources menu.

To restore the style to its original setting...

- 1 - While watching a TV channel, press **⚙**.
- 2 - Select **Picture > Picture style**, and select the Picture Style you want to restore.
- 3 - Press the colour key **— Restore style**, and press **OK**. The style is restored.
- 4 - Press **◀** (left) repeatedly if necessary, to close

the menu.

Home or Shop

If the **Picture style** is switched back to **Vivid** every time you switch on the TV, the TV location is set to **Shop**. A setting meant for in-store promotion.

To set the TV for Home use...

- 1 - Press **⚙️**, select **General settings** and press **➤** (right) to enter the menu.
- 2 - Select **Location > Home** and press **OK**.
- 3 - Press **⬅** (left) repeatedly if necessary, to close the menu.

Picture settings

Colour

With **Colour**, you can adjust the colour saturation of the picture.

To adjust the colour...

- 1 - Press **⚙️**, select **Picture** and press **➤** (right) to enter the menu.
- 2 - Select **Colour** and press **➤** (right).
- 3 - Press the arrows **⬆** (up) or **⬇** (down) to adjust the value.
- 4 - Press **⬅** (left) repeatedly if necessary, to close the menu.

Contrast

With **Contrast**, you can adjust the contrast of the picture.

To adjust the contrast...

- 1 - Press **⚙️**, select **Picture** and press **➤** (right) to enter the menu.
- 2 - Select **Contrast** and press **➤** (right).
- 3 - Press the arrows **⬆** (up) or **⬇** (down) to adjust the value.
- 4 - Press **⬅** (left) repeatedly if necessary, to close the menu.

Sharpness

With **Sharpness**, you can adjust the level of sharpness in fine detail of the picture.

To adjust the sharpness...

- 1 - Press **⚙️**, select **Picture** and press **➤** (right) to enter the menu.
- 2 - Select **Sharpness** and press **➤** (right).
- 3 - Press the arrows **⬆** (up) or **⬇** (down) to adjust the value.

4 - Press **⬅** (left) repeatedly if necessary, to close the menu.

Advanced picture settings

Game or computer

When you connect a device, the TV recognizes its type and gives each device a correct type name. You can change the type name if you wish. If a correct type name for a device is set, the TV automatically switches to the ideal TV settings when you switch to this device in the Sources menu.

If you have a game console with a built-in Blu-ray Disc player, you might have set the type name to Blu-ray Disc. With **Game or computer** you can switch to the ideal settings for gaming manually. Don't forget to switch the Game or Computer setting off, when you return to watch TV.

To switch to the ideal settings for gaming or computer manually...

- 1 - Press **⚙️**, select **Picture > Advanced** and press **OK**.
- 2 - Select **Game, Computer or Off**.
- 3 - Press **⬅** (left) to go back one step or press **⬅** **BACK** to close the menu.

Colour settings

Colour enhancement

With **Colour enhancement**, you can enhance the colour intensity and the details in bright colours.

To adjust the level...

- 1 - Press **⚙️**, select **Picture** and press **➤** (right) to enter the menu.
- 2 - Select **Advanced > Colour > Colour enhancement** and press **OK**.
- 3 - Select **Maximum, Medium, Minimum or Off**.
- 4 - Press **⬅** (left) repeatedly if necessary, to close the menu.

Colour temperature

With **Colour temperature**, you can set the picture to a preset colour temperature or select **Custom** to set a temperature setting yourself with **Custom colour temperature**. Colour Temperature and Custom Colour Temperature are settings intended for expert users.

To select a preset...

- 1 - Press **⚙️**, select **Picture** and press **➤** (right) to enter the menu.
- 2 - Select **Advanced > Colour > Colour temperature** and press **OK**.

- 3 - Select **Normal**, **Warm** or **Cool**. Or select **Custom** if you want to customise a colour temperature yourself.
- 4 - Press **◀** (left) repeatedly if necessary, to close the menu.

Custom colour temperature

With **Custom colour temperature**, you can set a colour temperature yourself. To set a custom colour temperature, first select **Custom** in the Colour Temperature menu. Custom Colour Temperature is a setting intended for expert users.

To set a custom colour temperature...

- 1 - Press **⚙️**, select **Picture** and press **▶** (right) to enter the menu.
- 2 - Select **Advanced > Colour > Custom colour temperature** and press **OK**.
- 3 - Press the arrows **▲** (up) or **▼** (down) to adjust the value. WP is white point and BL is black level. You can also select one of the presets in this menu.
- 4 - Press **◀** (left) repeatedly if necessary, to close the menu.

Contrast settings

Contrast modes

With **Contrast Mode**, you can set the level at which power consumption can be reduced by dimming the intensity of the screen. Choose for the best power consumption or for the picture with the best intensity.

To adjust the level...

- 1 - Press **⚙️**, select **Picture** and press **▶** (right) to enter the menu.
- 2 - Select **Advanced > Contrast > Contrast mode** and press **OK**.
- 3 - Select **Standard**, **Best power**, **Best picture**, or **Off**.
- 4 - Press **◀** (left) repeatedly if necessary, to close the menu.

Dynamic contrast

With **Dynamic Contrast**, you can set the level at which the TV automatically enhances the details in the dark, middle and light areas of the picture.

To adjust the level...

- 1 - Press **⚙️**, select **Picture** and press **▶** (right) to enter the menu.
- 2 - Select **Advanced > Contrast > Dynamic contrast** and press **OK**.
- 3 - Select **Maximum**, **Medium**, **Minimum** or **Off**.

- 4 - Press **◀** (left) repeatedly if necessary, to close the menu.

Brightness

With **Brightness**, you can set the level of brightness of the picture signal. Brightness is a setting intended for expert users. We recommend non-expert users to adjust the brightness of the picture with the **Contrast** setting.

To adjust the level...

- 1 - Press **⚙️**, select **Picture** and press **▶** (right) to enter the menu.
- 2 - Select **Advanced > Contrast > Brightness**, and press **OK**.
- 3 - Press the arrows **▲** (up) or **▼** (down) to adjust the value.
- 4 - Press **◀** (left) repeatedly if necessary, to close the menu.

Video contrast

With **Video Contrast**, you can decrease the range of the video contrast.

To adjust the level...

- 1 - Press **⚙️**, select **Picture** and press **▶** (right) to enter the menu.
- 2 - Select **Advanced > Contrast > Video contrast**, and press **OK**.
- 3 - Press the arrows **▲** (up) or **▼** (down) to adjust the value.
- 4 - Press **◀** (left) repeatedly if necessary, to close the menu.

Gamma

With **Gamma**, you can set a non-linear setting for picture luminance and contrast. Gamma is a setting intended for expert users.

To adjust the level...

- 1 - Press **⚙️**, select **Picture** and press **▶** (right) to enter the menu.
- 2 - Select **Advanced > Contrast > Gamma**, and press **OK**.
- 3 - Press the arrows **▲** (up) or **▼** (down) to adjust the value.
- 4 - Press **◀** (left) repeatedly if necessary, to close the menu.

Sharpness settings

Ultra Resolution

With **Ultra Resolution**, you switch on a superior sharpness in line edges and contours.

To switch on or off...

- 1 - Press **⚙️**, select **Picture** and press **➤ (right)** to enter the menu.
- 2 - Select **Advanced > Sharpness > Ultra Resolution**, and press **OK**.
- 3 - Select **On** or **Off**.
- 4 - Press **⬅ (left)** repeatedly if necessary, to close the menu.

Noise reduction

With **Noise reduction**, you can filter out and reduce the level of image noise.

To adjust the noise reduction...

- 1 - Press **⚙️**, select **Picture** and press **➤ (right)** to enter the menu.
- 2 - Select **Advanced > Sharpness > Noise reduction**, and press **➤ (right)** to enter the menu.
- 3 - Select **Maximum, Medium, Minimum** or **Off**.
- 4 - Press **⬅ (left)** repeatedly if necessary, to close the menu.

MPEG artefact reduction

With **MPEG artefact reduction**, you can smoothen the digital transitions in the picture. MPEG artefacts are mostly visible as small blocks or jagged edges in images.

To reduce the MPEG artefacts...

- 1 - Press **⚙️**, select **Picture** and press **➤ (right)** to enter the menu.
- 2 - Select **Advanced > Sharpness > MPEG artefact reduction**, and press **➤ (right)** to enter the menu.
- 3 - Select **Maximum, Medium, Minimum** or **Off**.
- 4 - Press **⬅ (left)** repeatedly if necessary, to close the menu.

Motion settings

Natural motion

With **Natural motion**, you can reduce the motion judder, visible in movies on TV. Natural Motion makes any movement smooth and fluent.

To adjust the motion judder...

- 1 - Press **⚙️**, select **Picture** and press **➤ (right)** to

enter the menu.

2 - Select **Advanced > Motion > Natural motion**, and press **OK**.

3 - Select **Maximum, Medium, Minimum** or **Off**.

4 - Press **⬅ (left)** repeatedly if necessary, to close the menu.

Picture format

Fill the screen settings

If the picture is not filling the whole screen, if black bars are showing on the top or bottom or at both sides, you can adjust the picture to fill the screen completely.

To select one of the basic settings to fill the screen...

- 1 - Press **⚙️**, select **Picture** and press **➤ (right)** to enter the menu.
- 2 - Select **Picture format** and press **➤ (right)**.
- 3 - Select **Fill screen, Fit to screen** or **Wide screen**, and press **OK**.
- 4 - Press **⬅ BACK** to close the menu.

- **Fill screen** – automatically enlarges the picture to fill the screen. Picture distortion is minimal, subtitles remain visible. Not suitable for PC input. Some extreme picture formats can still show black bars.
- **Fit to screen** – automatically zooms in the picture to fill the screen without distortion. Black bars may be visible. Not suitable for PC input.

Advanced

If the two basic settings are inadequate to format the picture you want, you can use the advanced settings. With the advanced settings you manually format the picture on your screen.

You can zoom, stretch and shift the picture until it shows what you need – e.g. missing subtitles or scrolling text banners. If you format the picture for a specific Source – like a connected game console – you can return to this setting the next time you use the game console. The TV stores the last setting you did for each connection.

To format the picture manually...

- 1 - Press **⚙️**, select **Picture** and press **➤ (right)** to enter the menu.
 - 2 - Select **Picture format** and press **➤ (right)**.
 - 3 - Select **Advanced** and press **OK**.
 - 4 - Use **Shift, Zoom, Stretch** or **Original** to adjust the picture. Select **Undo** to return to the setting the picture had when you opened **Picture Format**.
- **Last setting** – Select to return to the last setting.
 - **Shift** – Select on the arrows to shift the picture. You can only shift the picture when it is zoomed in.

- **Zoom** – Select on the arrows to zoom in.
- **Stretch** – Select on the arrows to stretch the picture vertically or horizontally.
- **Original** – Shows the original format of the incoming picture. This is a 1:1 pixel on pixel format. Expert mode for HD and PC input.
- **Undo** – Select to return to the picture format you started with.

18.3

Sound

Sound style

Select a style

For easy sound adjustment, you can select a preset setting with Sound Style.

- 1 - While watching a TV channel, press .
- 2 - Select **Sound** and press **➤** (right) to enter the menu.
- 3 - Select **Sound style**, and select one of the styles in the list.
- 4 - Press **◀** (left) repeatedly if necessary, to close the menu.

The available styles are...

- **Personal** - The sound preferences you set during the first start up.
- **Original** - Most neutral sound setting
- **Movie** - Ideal for watching movies
- **Music** - Ideal for listening to music
- **Game** - Ideal for gaming



- **News** - Ideal for speech

Restore a style

With a Sound Style selected, you can adjust any sound setting in **Setup > Sound...**

The selected style will store the changes you made. We recommend to adjust the sound settings for the style **Personal** only. The Sound Style - Personal can save its settings for each individual connected device in Sources menu.

To restore the style to its original setting...

- 1 - While watching a TV channel, press .
- 2 - Select **Sound** and press **➤** (right) to enter the menu.
- 3 - Select **Sound style**, and select the Sound Style you want to restore.
- 4 - Press the colour key  **Restore style**. The style is restored
- 5 - Press **◀** (left) repeatedly if necessary, to close the menu.

Sound settings

Bass

With **Bass**, you can adjust the level of low tones in the sound.

To adjust the level...

- 1 - Press , select **Sound** and press **➤** (right) to enter the menu.
- 2 - Select **Bass** and press **➤** (right).
- 3 - Press the arrows **▲** (up) or **▼** (down) to adjust the value.
- 4 - Press **◀** (left) repeatedly if necessary, to close the menu.

Treble

With **Treble**, you can adjust the level of high tones in the sound.

To adjust the level...

- 1 - Press , select **Sound** and press **➤** (right) to enter the menu.
- 2 - Select **Treble** and press **➤** (right).
- 3 - Press the arrows **▲** (up) or **▼** (down) to adjust the value.
- 4 - Press **◀** (left) repeatedly if necessary, to close the menu.

Surround mode

With **Surround Mode**, you can set the sound effect of the TV speakers.

To set the surround mode...

- 1 - Press , select **Sound** and press **➤** (right) to enter the menu.
- 2 - Select **Surround mode** and press **➤** (right) to enter the menu.
- 3 - Select **Stereo** or **Incredible surround**.
- 4 - Press **◀** (left) repeatedly if necessary, to close the menu.

Advanced sound settings

Auto volume levelling

With **Auto Volume Levelling**, you can set the TV to automatically level out sudden volume differences. Typically at the beginning of adverts or when you are switching channels.

To switch on or off...

- 1 - Press , select **Sound** and press **➤** (right) to enter the menu.
- 2 - Select **Advanced** and press **➤** (right) to enter

the menu.

3 - Select **Auto volume levelling** and press **➤** (right) to enter the menu.

4 - Select **On** or **Off**.

5 - Press **◀** (left) repeatedly if necessary, to close the menu.

Delta volume

With **Delta volume**, you can set the TV to automatically level out sudden volume differences.

To adjust the value...

1 - Press **⚙**, select **Sound** and press **➤** (right) to enter the menu.

2 - Select **Advanced** and press **➤** (right) to enter the menu.

3 - Select **Delta volume** and press **➤** (right) to enter the menu.

4 - Press the arrows **▲** (up) or **▼** (down) to adjust the value.

5 - Press **◀** (left) repeatedly if necessary, to close the menu.

TV speakers

You can send the TV sound to a connected audio device - a Home Theatre System or audio system.

You can select where you want to hear the TV sound and how you want to control it.

- If you select **TV speakers > Off**, you permanently switch off the TV speakers.

- If you select **TV speakers > On**, the TV speakers are always on.

With an audio device connected with HDMI CEC, you can use one of the EasyLink settings.

- If you select **EasyLink**, the TV sends the TV sound to the audio device. The TV will switch off the TV speakers when the device is playing the sound.

- If you select **EasyLink autostart**, the TV will switch on the audio device, send the TV sound to the device and switch off the TV speakers.

With EasyLink or EasyLink Autostart selected, you can still switch to TV speakers if necessary.

To set the TV speakers...

1 - Press **⚙**, select **Sound** and press **➤** (right) to enter the menu.

2 - Select **Advanced** and press **➤** (right) to enter the menu.

3 - Select **TV speakers** and press **➤** (right) to enter the menu.

4 - Select **On**, **Off**, **EasyLink**, or **EasyLink autostart**.

5 - Press **◀** (left) repeatedly if necessary, to close the menu.

To switch to speakers directly...

1 - While watching TV, press **⚙**.

2 - Select **Quick settings > Speakers** and select **TV** or **Amplifier** (audio system).

3 - Press **◀** (left) repeatedly if necessary, to close the menu.

Clear sound

With **Clear Sound**, you improve the sound for speech. Ideal for news programmes. You can switch the speech improvement on or off.

To switch on or off...

1 - Press **⚙**, select **Sound** and press **➤** (right) to enter the menu.

2 - Select **Advanced > Clear sound** and press **OK**.

3 - Select **On** or **Off**, then press **OK**.

4 - Press **◀** (left) repeatedly if necessary, to close the menu.

Audio out format

For more information, in **Help**, press the colour key **— Keywords** and look up **Audio out format**.

Audio out levelling

For more information, in **Help**, press the colour key **— Keywords** and look up **Audio out levelling**.

HDMI 1 - ARC

To switch on or off...

1 - Press **⚙**, select **Sound** and press **➤** (right) to enter the menu.

2 - Select **Advanced > HDMI 1 - ARC** and press **OK**.

3 - Select **On** or **Off**, then press **OK**.

4 - Press **◀** (left) repeatedly if necessary, to close the menu.

Audio out delay

If you set an Audio sync delay on your Home Theatre System, to synchronise the sound with the picture, you must switch off **Audio Out Delay** on the TV.

To switch off Audio Out Delay...

1 - Press **⚙**, select **Sound** and press **➤** (right) to enter the menu.

2 - Select **Advanced > Audio out delay** and press **OK**.

3 - Select **Off**.

4 - Press **◀** (left) repeatedly if necessary, to close the menu.

For more information, in **Help**, press the colour key **— Keywords** and look up **Audio out delay**.

Audio out offset

If you cannot set a delay on the Home Theatre System, you can set a delay on the TV with **Audio Out Offset**.

To synchronise the sound on the TV...

- 1 - Press **⚙️**, select **Sound** and press **➤ (right)** to enter the menu.
- 2 - Select **Advanced > Audio out offset** and press **OK**.
- 3 - Use the slider bar to set the sound offset and press **OK**.
- 4 - Press **⬅ (left)** repeatedly if necessary, to close the menu.

For more information, in **Help**, press the colour key **— Keywords** and look up **Audio out offset**.

Headphone volume

With **Headphones Volume**, you can set the volume of a connected headphone separately.

To adjust the volume...

- 1 - Press **⚙️**, select **Sound** and press **➤ (right)** to enter the menu.
- 2 - Select **Headphones volume** and press **OK**.
- 3 - Press the arrows **⬆ (down)** or **⬆ (down)** to adjust the value.
- 4 - Press **⬅ (left)** repeatedly if necessary, to close the menu.

TV placement

As part of the first installation, this setting is set to either **On a TV stand** or **On the wall**. If you have changed the placement of the TV since then, adjust this setting accordingly for best sound reproduction.

- 1 - Press **⚙️**, select **Sound** and press **➤ (right)** to enter the menu.
- 2 - Select **TV placement** and press **OK**.
- 3 - Select **On a TV stand** or **On the wall**.
- 4 - Press **⬅ (left)** repeatedly if necessary, to close the menu.

18.4

Eco settings

Energy saving

Eco settings **🌿** bundles the settings that help the environment.

Energy Saving

If you select Energy Saving, the TV switches to Picture Style - Standard automatically, the most ideal energy conscious setting for the picture.

To set the TV in Energy Saving...

- 1 - Press **⚙️**, select **Eco settings** and press **➤ (right)** to enter the menu.
- 2 - Select **Energy saving**, the **Picture style** is set to **Standard** automatically.
- 3 - Press **⬅ (left)** repeatedly if necessary, to close the menu.

Screen off

If you only listen to music, you can switch off the TV screen to save energy.

To only switch off the TV screen...

- 1 - Press **⚙️**, select **Eco settings** and press **➤ (right)** to enter the menu.
- 2 - Select **Screen off**.
- 3 - Press **⬅ (left)** repeatedly if necessary, to close the menu.

To switch the screen back on, press any key on the remote control.

Switch off timer

If the TV receives a TV signal but you don't press a key on the remote control during a 4 hour period, the TV switches off automatically to save energy. Also, if the TV does not receive a TV signal nor a remote control command for 10 minutes, the TV switches off automatically.

If you use the TV as a monitor or use a digital receiver to watch TV (a Set-Top Box - STB) and you do not use the remote control of the TV, you should deactivate this automatic switch off.

To deactivate the Switch Off Timer ...

- 1 - Press **⚙️**, select **Eco settings** and press **➤ (right)** to enter the menu.
- 2 - Select **Switch off timer** and press **OK**.
- 3 - Press the arrows **⬆ (down)** or **⬆ (down)** to adjust the value. The value **0** deactivates the automatic switch off.

4 - Press **◀** (left) repeatedly if necessary, to close the menu.

For more information on environmentally friendly TV settings, in **Help**, press the colour key **—** **Keywords** and look up **Eco settings**.

18.5

General settings

Languages

In **Help**, press **—** **Keywords** and look up **Language settings** for more information.

Clock

In **Help**, press **—** **Keywords** and look up **Clock settings** for more information.

Sleep timer

For more information, in **Help**, press the colour key **—** **Keywords** and look up **Sleep timer**.

Switch off timer

For more information, in **Help**, press the colour key **—** **Keywords** and look up **Switch off timer**.

EasyLink

EasyLink

To switch off EasyLink completely...

- 1 - Press **⚙**, select **General settings** and press **▶** (right) to enter the menu.
- 2 - Select **EasyLink**, press **▶** (right) and select **EasyLink** one step further.
- 3 - Select **Off**.
- 4 - Press **◀** (left) repeatedly if necessary, to close the menu.

EasyLink remote control

To switch off EasyLink remote control...

- 1 - Press **⚙**, select **General settings** and press **▶** (right) to enter the menu.
- 2 - Select **EasyLink > Easylink remote control**, and press **OK**.

3 - Select **Off**.

4 - Press **◀** (left) repeatedly if necessary, to close the menu.

HDMI Ultra HD

This TV can display Ultra HD signals. Some devices - connected with HDMI - do not recognise a TV with Ultra HD and might not work correctly or show distorted picture or sound. To avoid the malfunctioning of such a device, you can set the signal quality to a level the device can handle. If the device is not using Ultra HD signals, you can switch off Ultra HD for this HDMI connection.

The setting **UHD 4:4:4/4:2:2** allows UHD YCbCr 4:4:4 / 4:2:2 signals. The setting **UHD 4:2:0** allows UHD YCbCr 4:2:0 signals.

To set the signal quality...

- 1 - Press **⚙**, select **General settings** and press **▶** (right) to enter the menu.
- 2 - Select **HDMI Ultra HD > HDMI 3 & 4** and press **OK**.
- 3 - Select **UHD 4:4:4/4:2:2**, **UHD 4:2:0** or **UHD Off** and press **OK**.
- 4 - Press **◀** (left) repeatedly if necessary, to close the menu.

USB keyboard settings

To install the USB keyboard, switch on the TV and connect the USB keyboard to one of the **USB** connections on the TV. When the TV detects the keyboard for the first time, you can select your keyboard lay-out and test your selection. If you select a Cyrillic or Greek keyboard layout first, you can select a secondary Latin keyboard layout.

To change the keyboard layout setting when a layout was selected...

- 1 - Press **⚙**, select **General settings** and press **▶** (right) to enter the menu.
- 2 - Select **USB keyboard settings**, and press **OK** to start the keyboard setup.

Mouse settings

To Adjust the motion speed of the USB mouse...

- 1 - Press **⚙**, select **General settings** and press **▶** (right) to enter the menu.
- 2 - Select **Mouse settings**, and press **OK** to start the mouse speed setup.

Home or Shop

If the TV is installed in a shop, you can set the TV to display an in store promotion banner. **Picture style** is set to **Vivid** automatically. **Switch off timer** is switched off.

To set the TV to Shop location...

- 1 - Press **⚙️**, select **General settings** and press **➤ (right)** to enter the menu.
- 2 - Select **Location > Shop**, and press **OK**.
- 3 - Press **⬅ (left)** repeatedly if necessary, to close the menu.

If you use the TV at home, set the TV in Home location.

Shop setup

If the TV is set to **Shop**, you can set the availability of a specific demo for in store use.

- 1 - Press **⚙️**, select **General settings** and press **➤ (right)** to enter the menu.
- 2 - Select **Shop setup** and press **➤ (right)** to enter the menu.
- 3 - Select **banner**, and select **Commercial banner** or **Promotional banner** as in store demo.
- 4 - Press **⬅ (left)** repeatedly if necessary, to close the menu.

TV Guide

For more information, in **Help**, press the colour key **— Keywords** and look up **TV guide, data and information**.

Channel logos

In some countries, the TV can show the channel logos.

If you do not want these logos to appear, you can switch them off.

To switch off the logos...

- 1 - Press **⚙️**, select **General settings** and press **➤ (right)** to enter the menu.
- 2 - Select **Channel logos** and press **➤ (right)** to enter the menu.
- 3 - Select **Off** and press **OK**.
- 4 - Press **⬅ (left)** repeatedly if necessary, to close the menu.

HbbTV

If a TV channel offers HbbTV pages, you must first switch on HbbTV in the TV settings to view the pages.

- 1 - Press **⚙️**, select **General settings** and press **➤ (right)** to enter the menu.
- 2 - Select **HbbTV**, and press **OK**.
- 3 - Select **On** or **Off**.
- 4 - Press **⬅ (left)** repeatedly if necessary, to close the menu.

If you want to avoid access to HbbTV pages on a specific channel, you can block the HbbTV pages for this channel only.

- 1 - Tune to the channel of which you want to block the HbbTV pages.
- 2 - Press **≡ OPTIONS** and select **HBB TV on this channel** and press **OK**.
- 3 - Select **Off** and press **OK**.

Factory settings

You can set the TV back to the original TV settings (the factory settings).

To switch back to the original settings...

- 1 - Press **⚙️**, select **General settings** and press **➤ (right)** to enter the menu.
- 2 - Select **Factory settings** and press **OK**.
- 3 - Press **⬅ (left)** repeatedly if necessary, to close the menu.

Reinstall TV

You can redo a full TV installation. The TV is completely reinstalled.

To redo a full TV installation...

- 1 - Press **⚙️**, select **General settings** and select **Reinstall TV**.
- 2 - Follow the instructions on screen. The installation may take a few minutes.

Channel list copy

For more information, in **Help**, press the colour key **— Keywords** and look up **Channel List Copy, copy**.

CAM settings

Switch on operator profile

To switch on operator profile for CI+/CAM for easy channel installation and updates...

- 1 - Press , select **General settings** and press **>** (right) to enter the menu.
- 2 - Select **CAM Operator profile** and press **OK**.
- 3 - Select **Enable** and press **OK**
- 4 - Press **<** (left) repeatedly if necessary, to close the menu.

View CAM profile name

To display profile name of the CAM card connected...

- 1 - Press , select **General settings** and press **>** (right) to enter the menu.
- 2 - Select **CAM profile name** and press **OK**.
- 3 - Press **<** (left) repeatedly if necessary, to close the menu.

Universal access

For more information, in **Help**, press the colour key  **Keywords** and look up **Universal access**.

Child lock

Parental rating

To set a minimum age to watch rated programmes...

- 1 - Press , select **Child lock** and press **>** (right) to enter the menu.
- 2 - Select **Parental rating**, and select one of the age in the list.
- 3 - Press **<** (left) repeatedly if necessary, to close the menu.

Set code / Change code

The Child Lock PIN code is used to lock or unlock channels or programmes.

To set the lock code or to change the current code...

- 1 - Press , select **Child Lock** and press **>** (right) to enter the menu.
- 2 - Select **Set code** or **Change code** and press **OK**.
- 3 - Enter a 4 digit code of your choice. If a code is set already, enter the current Child Lock code and then enter the new code twice.
- 4 - Press **<** (left) repeatedly if necessary, to close the menu.

The new code is set.

Forgotten your Child Lock PIN code?

If you forgot your PIN code, you can override the current code and enter a new code.

- 1 - Press , select **Child lock** and press **>** (right) to enter the menu.
- 2 - Select **Change code** and press **OK**.
- 3 - Enter the overriding code **8888**.
- 4 - Now enter a new Child Lock PIN code and enter it again to confirm.
- 5 - Press **<** (left) repeatedly if necessary, to close the menu.

The new code is set.

CAM PIN

For more information, in **Help**, press the colour key  **Keywords** and look up **CAM PIN**.

18.6

Clock and language

Menu language

To change the language of the TV menus and messages...

- 1 - Press , select **General settings > Language > Menu language** and press **OK**.
- 2 - Select on the language you need.
- 3 - Press **<** (left) repeatedly if necessary, to close the menu.

Language preferences

Audio language settings

Digital TV channels can broadcast audio with several spoken languages for a programme. You can set a preferred primary and secondary audio language. If audio in one of these languages is available, the TV will switch to this audio.

If none of the preferred audio languages is available, you can select another audio language which is available.

To set the primary and secondary audio language...

- 1 - Press , select **General settings > Languages > Primary audio** or **Secondary audio** and press **OK**.
- 2 - Select on the language you need.
- 3 - Press **<** (left) repeatedly if necessary, to close the menu.

To select an audio language when none of your preferred audio language is available...

- 1 - Press **≡** **OPTIONS** .
- 2 - Select **Audio language** and select on the audio language you want temporarily.

Subtitles

Switch on

To switch on Subtitles, press **SUBTITLE**.

You can switch subtitles **On**, **Off** or **On during mute**.

Or to show subtitles automatically when the broadcasted programme is not in language – the language set for the TV – select **Automatic**. This setting will also show Subtitles automatically when you mute the sound.

Subtitle language settings

Digital channels can offer several subtitle languages for a programme. You can set a preferred primary and secondary subtitle language. If subtitles in one of these languages are available, the TV will show the subtitles you selected.

If none of the preferred subtitle languages are available, you can select another subtitle language which is available.

To set the primary and secondary subtitle language...

- 1 - Press **⚙**, select **General settings > Languages > Primary subtitles** or **Secondary subtitles** and press **OK**.
- 2 - Select on the language you need.
- 3 - Press **◀** (left) repeatedly if necessary, to close the menu.

To select a subtitle language when none of your preferred languages are available...

- 1 - Press **≡** **OPTIONS** .
- 2 - Select **Subtitle language** and select on the language you want temporarily.

Subtitles from Text

If you tune to an analogue channel, you need to make the subtitles available for each channel manually.

- 1 - Switch to a channel and press **TEXT** to open Text.
- 2 - Enter the page number for subtitles, usually **888**.
- 3 - Press **TEXT** again, to close Text.

If you select **On** in the Subtitle menu when watching this analogue channel, subtitles will be shown if

available.

To know if a channel is analogue or digital, switch to the channel and open **Channel Info** in **≡** **OPTIONS**.

Text / Teletex Languages

Text pages

To open Text/Teletext press **TEXT**, while you are watching TV channels.

To close Text, press **TEXT** again.

Select a Text page

To select a page . . .

- 1 - Enter the page number with the number keys.
- 2 - Use the arrow keys to navigate.
- 3 - Press a colour key to select a colour-coded subject at the bottom of the screen.

Text sub-pages

A Text page number can hold several subpages. The subpage numbers are shown on a bar next to the main page number.

To select a subpage, press **◀** or **▶**.

T.O.P. Text pages

Some broadcasters offer T.O.P. Text.

To open T.O.P. Text pages within Text, press **≡** **OPTIONS** and select **T.O.P. overview**.

Favourite pages

The TV makes a list of the last 10 Text pages you opened. You can easily reopen them again in the Favourite Text pages column.

- 1 - In Text, select the star in the top left corner of the screen to show the column of favourite pages.
- 2 - Press **▼** (down) or **▲** (up) to select a page number and press **OK** to open the page. You can clear the list with the option **Clear favourite pages**.

Search Text





You can select a word and scan Text for all occurrences of this word.

- 1 - Open a Text page and press **OK**.
- 2 - Select a word or number with the arrow keys.
- 3 - Press **OK** again to jump immediately to the next occurrence of this word or number.
- 4 - Press **OK** again to jump to the subsequent occurrence.
- 5 - To stop searching, press **▲** (up) until nothing is selected.

Text from a connected device

Some devices that receive TV channels can also offer Text.

To open Text from a connected device . . .

- 1 - Press  select the device and press **OK**.
- 2 - While watching a channel on the device, press  **OPTIONS**, select **Show device keys** and select the  key and press **OK**.
- 3 - Press  **BACK** to hide the device keys.
- 4 - To close Text, press  **BACK** again.

Digital Text (UK only)

Some digital broadcasters offer dedicated Digital Text or interactive TV on their digital TV channels. This includes normal Text using the number, colour and arrow keys to select and navigate.

To close Digital Text, press  **BACK**.

Text options

In Text/Teletext, press  **OPTIONS** to select the following...

- **Freeze page**

To stop the automatic rotation of subpages.

- **Dual screen / Full screen**

To show the TV channel and Text alongside each other.

- **T.O.P. overview**

To open T.O.P. Text.

- **Enlarge**

To enlarge the Text page for comfortable reading.

- **Reveal**

To unhide hidden information on a page.

- **Cycle subpages**

To cycle subpages when these are available.

- **Language**

To switch the group of characters that Text uses to display correctly.

- **Text 2.5**



To activate the Text 2.5 for more colours and better graphics.

Text setup

Text language

Some digital TV broadcasters have several Text languages available.



To set your primary and secondary Text language . . .

- 1 - Press , select **General settings** > **Language** > **Primary text** or **Secondary text** and press **OK**.
- 2 - Select your preferred Text languages.
- 3 - Press  (left) repeatedly if necessary, to close the menu.

Text 2.5

If available, Text 2.5 offers more colours and better graphics. Text 2.5 is activated as a standard factory setting.

To switch off Text 2.5...

- 1 - Press **TEXT**.
- 2 - With Text/Teletext open on screen, press  **OPTIONS**.
- 3 - Select **Text 2.5** > **Off**.
- 4 - Press  (left) repeatedly if necessary, to close the menu.

Clock



Date and time

Automatic

In some countries, digital broadcasts do not send UTC - Coordinated Universal Time information. The daylight saving change might be ignored and the TV might show an incorrect time.



When you record programmes - scheduled in the TV Guide, we recommend not to change the time and date manually. In some countries, for some network operators, the **Clock** setting is hidden to avoid an incorrect clock setting.

To correct the TV clock automatically...

- 1 - Press , select **General settings** > **Clock** > **Auto clock mode**, and select **Country dependent**.
- 2 - Select **Daylight savings** and select the appropriate setting.
- 3 - Press  (left) repeatedly if necessary, to close the menu.



Manual

To set the TV clock manually...

- 1 - Press , select **General settings** > **Clock** > **Auto clock mode**, and select **Manual**.
- 2 - Select **Date** and **Time** to adjust.
- 3 - Press  (left) repeatedly if necessary, to close the menu.





Time zone

To set the time zone...

- 1 - Press , select **General settings** > **Clock** > **Time zone**, and press **OK**.
- 2 - Select one of the time zones.
- 3 - Press  (left) repeatedly if necessary, to close the menu.

Manual time offset

To adjust time offset...

- 1 - Press , select **General settings** > **Clock** > **Manual time offset**, and press **OK**.
- 2 - Press the arrows  (up) or  (down) to adjust the value.
- 3 - Press  (left) repeatedly if necessary, to close the menu.

18.7

Universal access



Switch on

With **Universal access** switched on, the TV is prepared for use for the deaf, hard of hearing, blind or partially sighted people.

Switch on

If you did not switch on **Universal access** during the installation, you can still switch it on in **Universal access** menu.

To switch on **Accessibility**...





- 1 - Press , select **Universal access** and press  (right) to enter the menu.
- 2 - Select **Universal access** one step further.
- 3 - Select **On** and press **OK**.
- 4 - Press  (left) repeatedly if necessary, to close the menu.

With **Universal access** switched on, the option **Universal access** is added in the **Options** menu.

Hard of hearing

Some digital TV channels broadcast special audio and subtitles adapted for the hard of hearing or deaf people. With **Hearing impaired** switched on, the TV automatically switches to the adapted audio and subtitles, if available. Before you can switch on **Hearing impaired**, you have to switch on **Universal access**.



To switch on **Hearing impaired**...

- 1 - Press , select **Universal access** and press  (right) to enter the menu.
- 2 - Select **Hearing impaired** and press  (right) to enter the menu.
- 3 - Select **On** and press **OK**.
- 4 - Press  (left) repeatedly if necessary, to close the menu.

To switch on **Hearing impaired** while watching TV...

1 - While watching a TV channel, press  **OPTIONS**, select **Universal access** and press **OK**.

2 - Select **Hearing impaired**, and select **On**.

To check whether a hearing impaired audio language is available, press  **OPTIONS**, select **Audio Language** and look for an audio language marked with a .

If **Accessibility** does not appear in the **Options** menu, switch on **Universal access** in setup menu.

For more information, in **Help**, press the colour key  **Keywords** and look up **Universal access**.

Audio description

Switch on

Digital TV channels can broadcast special audio commentary describing what is happening on screen.





To be able to set the visually impaired audio and effects, you have to switch on **Audio description** first.

Also, before you can switch on **Audio description**, you have to switch on **Universal access** in setup menu.

With **Audio Description**, a narrator's commentary is added to the normal audio.

To switch on the commentary (if available)...

To switch on **Audio Description**...

- 1 - Press , select **Universal access** and press  (right) to enter the menu.
- 2 - Select **Audio description** and press  (right) to enter the menu.
- 3 - Select **Audio description** one step further
- 4 - Select **On** and press **OK**.
- 5 - Press  (left) repeatedly if necessary, to close the menu.

To switch on **Audio description** while watching TV...

- 1 - While watching a TV channel, press  **OPTIONS**, select **Universal access** and press **OK**.
- 2 - Select **Audio description**, and select **On**.

You can check if an audio commentary is available. In the **Options** menu, select **Audio language** and look for an audio language marked with a .

Speakers/Headphones

With **Speakers/Headphones**, you can select where you want to hear the audio commentary. On the TV speakers only, on the headphones only or on both.

To set **Speakers/Headphones**...

- 1 - Press , select **Universal access** and press **>** (right) to enter the menu.
 - 2 - Select **Audio Description** > **Speakers/Headphones** and press **OK**.
 - 3 - Select **Speakers**, **Headphones** or **Speakers + Headphones** and press **OK**.
 - 4 - Press **<** (left) repeatedly if necessary, to close the menu.
-

Mixed volume

You can mix the volume of the normal audio with the audio commentary.

To mix the volume...

- 1 - Press , select **Universal access** and press **>** (right) to enter the menu.
 - 2 - Select **Audio Description** > **Mixed volume** and press **OK**.
 - 3 - Press the arrows **^** (up) or **v** (down) to adjust the value.
 - 4 - Press **<** (left) repeatedly if necessary, to close the menu.
-

Audio effect

Some audio commentary can hold extra audio effects, like stereo or fading sound.

To switch on **Audio effects** (if available)...

- 1 - Press , select **Universal access** and press **>** (right) to enter the menu.
 - 2 - Select **Audio description** > **Audio effects** and press **OK**.
 - 3 - Press **<** (left) repeatedly if necessary, to close the menu.
-

Speech

The audio commentary can also hold subtitles for the words which are spoken.

To switch on these subtitles (if available) . . .

- 1 - Press , select **Universal access** and press **>** (right) to enter the menu.
- 2 - Select **Audio description** > **Speech** and press **OK**.
- 3 - Select **Descriptive** or **Subtitles** and press **OK**.
- 4 - Press **<** (left) repeatedly if necessary, to close the menu.

Networks

For more information, in **Help**, press the colour key **— Keywords** and look up **Network**, for more information on connecting the TV to a network.

Channel installation

Antenna/cable installation

Update channels

Automatic channel update

If you receive digital channels, you can set the TV to automatically update the list with new channels. Alternatively, you can start a channel update yourself.

Automatic channel update

Once a day, at 6 AM, the TV updates the channels and stores new channels. New channels are stored in the All channels list but also in the New channels list. Empty channels are removed.

If new channels are found or if channels are updated or removed, a message is shown at TV start up. The TV must be in standby to automatically update channels.

To switch off the message at start up . . .

- 1 - Press , select **Antenna/cable installation** and press **OK**.
- 2 - Enter your PIN code if necessary.
- 3 - Select **Automatic channel update** and press **OK**.
- 4 - Select **Off** and press **OK**.
- 5 - Press **← BACK** to close the menu.

When new channels are found or if channels are updated or removed, a message is shown at TV start up. To avoid this message to appear after every channel update, you can switch it off.

To switch off the message...

- 1 - Press , select **Antenna/cable installation** and press **OK**.
- 2 - Enter your PIN code if necessary.
- 3 - Select **Channel update message** and press **OK**.
- 4 - Select **Off** and press **OK**.
- 5 - Press **← BACK** to close the menu.

In certain countries, the Automatic channel update is done while watching TV or on any moment when the TV is in standby.

Manual channel update

You can always start an channel update yourself.

To start a channel update manually...

- 1 - Press , select **Antenna/cable installation** and press **OK**.
- 2 - Enter your PIN code if necessary.

- 3 - Select **Search for channels** and press **OK**.
- 4 - Select **Start now** and press **OK**.
- 5 - Select **Update channels** and press **OK**.
- 6 - Press **← BACK** to close the menu.

Reinstall channels

Reinstall all channels

You can reinstall all channels and leave all other TV settings untouched.

If a PIN code is set, you will need to enter this code before you can reinstall channels.

To reinstall channels...

- 1 - Press , select **Antenna/cable installation** and press **OK**.
- 2 - Enter your PIN code if necessary.
- 3 - Select **Search for channels** and press **OK**.
- 4 - Select **Start now** and press **OK**.
- 5 - Select **Re-install channels**, select **Next** and press **OK**.
- 6 - Select the country where you are now and press **OK**.
- 7 - Select **Antenna (DVB-T)** or **Cable (DVB-C)**.
- 8 - Select **Start** and press **OK** to update channels. This can take a few minutes.
- 9 - Press **← BACK** to close the menu.

Reinstall TV

You can redo a full TV installation. The TV is completely reinstalled.

To redo a full TV installation...

- 1 - Press , select **General Settings > Reinstall TV** and press **OK**.
- 2 - Enter your PIN code if necessary.
- 3 - Select **Yes** and press **OK** to confirm.
- 4 - The TV will reinstall completely. All settings will be reset and installed channels will be replaced. The installation can take a few minutes.
- 5 - Press **← BACK** to close the menu.

DVB-T or DVB-C

DVB-T or DVB-C reception

During the channel installation, just before you search for channels, you selected Antenna (DVB-T) or Cable (DVB-C). Antenna DVB-T searches for terrestrial analogue channels and digital DVB-T channels. Cable DVB-C searches for analogue and digital channels available from a cable DVB-C operator.

DVB-C Channel Installation

For ease of use, all DVB-C settings are set to automatic.

If your DVB-C operator gave you specific DVB-C values, the network ID or network frequency, enter these values when the TV asks for them during installation.

Channel Number Conflicts

In some countries, different TV channels (broadcasters) might have the same channel number. While installing, the TV shows the list with channel number conflicts. You need to select which TV channel you want to install on a channel number with multiple TV channels.

DVB settings

Access DVB settings

- 1 - Press , select **Antenna/cable installation** and press **OK**.
- 2 - Enter your PIN code if necessary.
- 3 - Select **Search for channels** and press **OK**.
- 4 - Select **Start now** and press **OK**.
- 5 - Select **Re-install channels**, select **Next** and press **OK**.
- 6 - Select the country where you are now and press **OK**.
- 7 - Select **Cable (DVB-C)**.
- 8 - Select **Start to search channels**, or select **Settings for DVB-C settings**.
- 9 - Press **← BACK** to close the menu.

Network frequency mode

If you intend to use the fast **Quick scan** method in **Frequency scan** to search for channels, select **Automatic**. The TV will use 1 of the predefined network frequencies (or HC - homing channel) as used by most cable providers in your country.

If you received a specific network frequency value to search for channels, select **Manual**.

Network frequency

With the **Network frequency mode** set to **Manual**, you can enter the network frequency value received from your cable provider here. To enter the value, use the number keys.

Frequency scan

Select the method of searching for channels. You can select the faster **Quick scan** method and use the predefined settings used by most cable providers in your country.

If this results in having no channels installed or if some channels are missing, you can select the extended **Full scan** method. This method will take more time to search for and install channels.

Frequency step size

The TV searches for channels in steps of **8MHz**.

If this results in having no channels installed or if some channels are missing, you can search in smaller steps of **1MHz**. Using the 1MHz steps will take more time to search for and install channels.

Digital channels

If you know your cable operator is not offering digital channels, you can skip searching for digital channels.

Analogue channels

If you know your cable operator is not offering analogue channels, you can skip searching for analogue channels.

Free / Scrambled

If you have a subscription and a CAM - Conditional Access Module for pay TV services, select **Free + Scrambled**. If you did not subscribe to pay TV channels or services, you can select **Free Channels Only**.

For more information, in **Help**, press the colour key  **Keywords** and look up **CAM, conditional access module**.

Reception quality

You can check the quality and signal strength of a digital channel. If you have your own antenna, you can reposition the antenna to try and improve the reception.

To check the reception quality of a digital channel...

- 1 - Tune to the channel.
- 2 - Press , select **Antenna/Cable Installation** and press **OK**. Enter your PIN code if necessary.
- 3 - Select **Digital: Reception Test** and press **OK**.

The digital frequency is shown for this channel. If the reception is poor, you can reposition your antenna. To check the signal quality of this frequency again, select **Search** and press **OK**. To enter a specific digital frequency yourself, use the remote control digit keys. Alternatively, select the

frequency, position the arrows on a number with **<** and **>** and change the number with **▲** and **▼**. To check the frequency, select **Search** and press **OK**.

If you use DVB-C to receive channels, the option **Symbol rate mode** is available. For Symbol rate mode, select **Automatic**, unless your cable provider gave you a specific symbol rate value. To enter the symbol rate value, use the number keys.

Manual installation

Analogue TV channels can be manually installed, channel by channel.

To install analogue channels manually...

1 - Press **⚙**, select **Antenna/Cable Installation** and press **OK**. Enter your PIN code if necessary.

2 - Select **Analogue: Manual Installation** and press **OK**.

• System

To set up the TV system, select **System**.

Select your country or the part of the world where you are now and press **OK**.

• Search Channel

To find a channel, select **Search Channel** and press **OK**. You can enter a frequency yourself to find a channel or let the TV search for a channel.

Press **>** (right) to select **Search** and press **OK** to search for a channel automatically. The found channel is shown on screen and if the reception is poor, press **Search** again. If you want to store the channel, select **Done** and press **OK**.

• Fine tune

To fine tune a channel, select **Fine tune** and press **OK**. You can fine tune the channel with **▲** or **▼**.

If you want to store the channel found, select **Done** and press **OK**.

• Store

You can store the channel on the current channel number or as a new channel number.

Select **Store Current Channel** or **Store as New Channel** and press **OK**. The new channel number is shown briefly.

You can redo these steps until you have found all available analogue TV channels.

Channel list copy

Introduction

Channel List Copy is intended for dealers and expert users.

With Channel List Copy, you can copy the channels installed on one TV onto another Philips TV of the same range. With Channel List Copy, you avoid the time-consuming channel search by uploading a predefined channel list on a TV. Use a USB flash drive of minimum 1 GB.

Conditions

- Both TVs are from the same year range.
- Both TVs have the same hardware type. Check the hardware type on the TV type plate on the back of the TV. Typically noted as Q . . . LA
- Both TVs have compatible software versions.

Current software version

To check the current version of the TV software...

1 - Press **⚙**, select **Update Software** and press **>** (right) to enter the menu.

2 - Select **Current Software Info** and press **OK**.

3 - The version, release notes and creation date are shown. Also, the Netflix ESN Number is shown if available.

4 - Press **<** (left) repeatedly if necessary, to close the menu.

Copy a channel list

To copy a channel list...

1 - Switch on the TV. This TV should have channels installed.

2 - Plug in a USB flash drive.

3 - Press **⚙**, select **General settings > Channel List Copy** and press **OK**.

4 - Select **Copy to USB** and press **OK**. You might be asked to enter the Child Lock PIN code to copy the channel list.

5 - When copying is done, unplug the USB flash drive.

6 - Press **<** (left) repeatedly if necessary, to close the menu.

Now you can upload the copied channel list onto another Philips TV.

Upload a channel list

To not installed TVs

Depending on whether your TV is already installed or not, you must use a different method to upload a channel list.



To a TV that is not yet installed

- 1 - Plug in the power plug to start the installation and select language and country. You can skip the channel search. Finish the installation.
- 2 - Plug in the USB flash drive that holds the channel list of the other TV.
- 3 - To start the channel list upload, press , select **General settings** and press **OK**.
- 4 - Select **Channel List Copy > Copy to TV** and press **OK**. Enter your PIN code if necessary.
- 5 - The TV notifies you if the channel list is copied to the TV successfully. Unplug the USB flash drive.

To installed TVs

Depending on whether your TV is already installed or not, you must use a different method to upload a channel list.

To an already installed TV

- 1 - Verify the country setting of the TV. (To verify this setting, see chapter Reinstall All Channels. Start this procedure until you reach the country setting. Press  **BACK** to cancel the installation.) If the country is correct continue with step 2. If the country is not correct, you need to start a reinstallation. See chapter Reinstall All Channels and start the installation. Select the correct country and skip the channels search. Finish the installation. When done, continue with step 2.
- 2 - Plug in the USB flash drive that holds the channel list of the other TV.
- 3 - To start the channel list upload, press , select **General settings** and press **OK**.
- 4 - Select **Channel List Copy > Copy to TV** and press **OK**. Enter your PIN code if necessary.
- 5 - The TV notifies you if the channel list is copied to the TV successfully. Unplug the USB flash drive.

Software

21.1

Update software

Update from Internet

If the TV is connected to the Internet, you may receive a message from TP Vision to update the TV software. You need a high-speed (broadband) Internet connection.

If you receive this message, we recommend you carry out the update.

Select **Update**. Follow the instructions on screen.

You can also look for new updates yourself.

To look for an update . . .

- 1 - Press **⚙️**, select **Update software > Search for updates**, then press **OK**.
- 2 - Select **Internet**, then press **OK**. Follow the instructions on screen.

When the update is complete, the TV switches off and back on again automatically.

Wait for the TV to switch itself back on.

Update from USB

It might be necessary to update the TV software. You need a computer with an high-speed Internet connection and a USB memory device to upload the software on the TV. Use a USB memory device with 512MB free space. Make sure that write protection is switched off.

1 - Start the update on TV

Press **⚙️**, select **Update software > Search for updates**, then press **OK**.

Select **USB** and press **OK**.

2 - Identify the TV

Insert the USB memory into one of the USB connections of the TV.

Select **Start** and press **OK**. An identification file is written on the USB memory device.

3 - Download the TV software

Insert the USB memory into your computer.

On the USB memory device, locate the

file **update.htm** and double click it.

Click on **Send ID**.

If new software is available, download the .zip file.

After the download, unzip the file and copy the

file **autorun.upg** onto the USB memory device.

Do not place this file in a folder.

4 - Update the TV software

Insert the USB memory into the TV again. The update starts automatically.

The TV switches itself off for 10 seconds and then back on again. Please wait.

Do not . . .

- use the remote control
- remove the USB memory device from the TV

If a power cut occurs during the update, never remove the USB memory device from the TV. When the power returns, the update will continue.

At the end of the update, the message **Operation successful** appears on screen. Remove the USB memory device and press **⏻** on the remote control.

Do not . . .

- press **⏻** twice
 - press the power switch on the TV
- The TV switches itself off (for 10 seconds) and then back on again. Please wait.

The TV software has been updated. You can use the TV again.

To prevent an accidental update of the TV software, delete the **autorun.upg** file from the USB memory device.

21.2

Software version

To view the current TV software version...

- 1 - Press **⚙️**, select **Update Software > Current Software Info** and press **OK**.
- 2 - The version, **Release Version** is shown. Also, the Netflix ESN Number is shown if available.
- 3 - Press **⬅️** (left) repeatedly if necessary, to close the menu.

21.3

Local updates

For dealers and expert users...

- 1 - Press **⚙️**, select **Update Software > Local updates** and press **OK**.
- 2 - Follow the on-screen instruction.
- 3 - Press **⬅️** (left) repeatedly if necessary, to close the menu.

21.4

Look for OAD updates

Search for an Over-the-air software update...

- 1 - Press **⚙️**, select **Update Software > Look for OAD updates** and press **OK**.
- 2 - Select **Start now**. Follow the on-screen instruction.

3 - Press ◀ (left) repeatedly if necessary, to close the menu.

21.5

Open source software

This television contains open source software. TP Vision Europe B.V. hereby offers to deliver, upon request, a copy of the complete corresponding source code for the copyrighted open source software packages used in this product for which such offer is requested by the respective licences.

This offer is valid up to three years after product purchase to anyone in receipt of this information. To obtain the source code, please write in English to .

Intellectual Property Dept.
TP Vision Europe B.V.
Prins Bernhardplein 200
1097 JB Amsterdam
The Netherlands

21.6

Open source license

About open source license

Acknowledgements and License Texts for any open source software used in this Philips TV.

This is a document describing the distribution of the source code used on the Philips TV, which fall either under the GNU General Public License (the GPL), or the GNU Lesser General Public License (the LGPL), or any other open source license. Instructions to obtain source code for this software can be found in the user manual.

PHILIPS MAKES NO WARRANTIES WHATSOEVER, EITHER EXPRESS OR IMPLIED, INCLUDING ANY WARRANTIES OF MERCHANTABILITY OR FITNESS FOR A PARTICULAR PURPOSE, REGARDING THIS SOFTWARE. Philips offers no support for this software. The preceding does not affect your warranties and statutory rights regarding any Philips product(s) you purchased. It only applies to this source code made available to you.

Open source license information

Freetype (2.4.3)

FreeType is a software font engine that is designed to be small, efficient, highly customizable, and portable while capable of producing high-quality output (glyph images).

This piece of software is made available under the terms and conditions of the FreeType Project license, which can be found below.

Source: <http://freetype.sourceforge.net>

zlib (1.2.3)

The 'zlib' compression library provides in-memory compression and decompression functions, including integrity checks of the uncompressed data.

This piece of software is made available under the terms and conditions of the zlib license, which can be found below.

Source: <http://www.zlib.net/>

Fraunhofer AAC Ecnoder (3.3.3)

AAC Ecnoder.

Source: Android JB source code

unicode (3.2)

This library is used to perform UNICODE string manipulation.

This piece of software is made available under the terms and conditions of the ICU license, which can be found below.

Source: <http://www.icu-project.org/>

libpng (1.2.43)

PNG decoder.

This piece of software is made available under the terms and conditions of the libpng license, which can be found below.

Source: <http://www.libpng.org/pub/png/libpng.html>

libjpg (6b)

This library is used to perform JPEG decoding tasks.

This piece of software is made available under the terms and conditions of the libjpg license, which can be found below.

Source: <http://www.ijg.org/>

libmng (1.0.10)

libmng -THE reference library for reading, displaying, writing and examining Multiple-Image Network Graphics.MNG is the animation extension to the popular PNG image-format.

This piece of software is made available under the terms and conditions of the libmng license, which can be found below.

Source:

<http://sourceforge.net/projects/libmng/files/>

u-Boot loader (1.3.4)

Used by boot loader and only linked with boot loader, GPL license.

This piece of software is made available under the terms and conditions of the u-Boot loader license, which can be found below.

Source: <http://sourceforge.net/projects/u-boot/files/u-boot/U-Boot-1.1.4/u-boot-1.1.4.tar.bz2/download>

Libcurl (7.21.7)

HTTP client; libcurl is a free and easy-to-use client-side URL transfer library, supporting FTP, HTTPS, HTTP, HTTPS, SCP, SFTP, TFTP, TELNET, DICT, LDAP, LDAPS, FILE, IMAP, SMTP, POP3 and RTSP. libcurl supports SSL certificates, HTTP POST, HTTP PUT, FTP uploading, HTTP form based upload, proxies, cookies, user+password authentication (Basic, Digest, NTLM, Negotiate, Kerberos4), file transfer resume, http proxy tunneling and more!

This piece of software is made available under the terms and conditions of the Libcurl license, which can be found below.

Source: <http://curl.haxx.se/>

c-ares (1.7.4)

c-ares is a C library that performs DNS requests and name resolves asynchronously.

This piece of software is made available under the terms and conditions of the c-ares license, which can be found below.

Source: <http://c-ares.haxx.se/c-ares-1.7.1.tar.gz>

openssl (1.0.0d)

OpenSSL is an open source implementation of the SSL and TLS protocols. The core library (written in the C programming language) implements the basic cryptographic functions and provides various utility functions. Wrappers allowing the use of the OpenSSL library in a variety of computer languages are available.

This piece of software is made available under the terms and conditions of the 1.7.4 license, which can be found below.

Source: <http://www.openssl.org/source/openssl-1.0.0.tar.gz>

Expat (2.01)

xml parser; Expat is an XML parser library written in C. It is a stream-oriented parser in which an application registers handlers for things the parser might find in the XML document (like start tags). An introductory article on using.

This piece of software is made available under the terms and conditions of the Expat license, which can be found below.

Source: <http://expat.sourceforge.net/>

DirectFB include SAWMAN (1.4.0)

It is a software library for GNU/Linux/UNIX based operating system with a small memory footprint that provides graphics acceleration, input device handling

and abstraction layer, and integrated windowing system with support for translucent windows and multiple display layers on top of the Linux framebuffer without requiring any kernel modifications.

This piece of software is made available under the terms and conditions of the DirectFB license, which can be found below.

Source: http://sourceforge.net/projects/jointspace/files/remote_applications_SDK/remote_applications_SDK_v1.3.1/DirectFB141_source_1.3.1.7z/download

SAWMAN

SquashFS is a compressed read-only file system for Linux. SquashFS compresses files, inodes and directories, and supports block sizes up to 1 MB for greater compression. SquashFS is also the name of free/open software, licensed under the GPL, for accessing SquashFS filesystems.

Source: <http://squashfs.sourceforge.net/>

Linux Kernel (3.0)

The Linux kernel is an operating system kernel used by the Linux family of Unix-like operating systems. This piece of software is made available under the terms and conditions of the Linux Kernel license, which can be found below.

Source: <http://www.kernel.org>

SQLite (3.7.2)

SQLite is a in-process library that implements a self-contained, serverless, zero-configuration, transactional SQL database engine.

This piece of software is made available under the terms and conditions of the SQLite license, which can be found below.

Source: <http://www.sqlite.org/download.html>

SquashFS (3.4)

SquashFS is a compressed read-only file system for Linux. SquashFS compresses files, inodes and directories, and supports block sizes up to 1 MB for greater compression. SquashFS is also the name of free/open software, licensed under the GPL, for accessing SquashFS filesystems.

This piece of software is made available under the terms and conditions of the SquashFS license, which can be found below.

Source: <http://squashfs.sourceforge.net/>

glibc (2.6.1)

Any Unix-like operating system needs a C library: the library which defines the "system calls" and other basic facilities such as open, malloc, printf, exit...The GNU C library is used as the C library in the GNU system and most systems with the Linux kernel. This piece of software is made available under the terms and conditions of the glibc license, which can be found below.

Source: <http://www.gnu.org/software/libc/>

mtd-utils (1)

The aim of the system is to make it simple to provide a driver for new hardware, by providing a generic interface between the hardware drivers and the upper layers of the system. Hardware drivers need to know nothing about the storage formats used, such as FTL, FFS2, etc., but will only need to provide simple routines for read, write and erase. Presentation of the device's contents to the user in an appropriate form will be handled by the upper layers of the system. This piece of software is made available under the terms and conditions of the mtd-utils license, which can be found below.

Source: <http://www.linux-mtd.infradead.org/index.html>

libusb (1.0.6)

This is the home of libusb, a library that gives user level applications uniform access to USB devices across many different operating systems. libusb is an open source project licensed under the GNU Lesser General Public License version 2.1. Many participants in the libusb community have helped and continue to help with ideas, implementation, support and improvements for libusb.

This piece of software is made available under the terms and conditions of the libusb license, which can be found below.

Source:
<http://libusb.wiki.sourceforge.net>
<http://www.libusb.org/>

libusb-compat (0.1.3)

Library to enable user space application programs to communicate with USB devices.

This piece of software is made available under the terms and conditions of the libusb-compat license, which can be found below.

Source:
<http://libusb.wiki.sourceforge.net/LibusbCompat0.1>

NTFS-3G Read/Write Driver (2010.5.22)

NTFS-3G is an open source cross-platform implementation of the Microsoft Windows NTFS file system with read-write support. NTFS-3G often uses the FUSE file system interface, so it can run unmodified on many different operating systems. It is runnable on Linux, FreeBSD, NetBSD, OpenSolaris, BeOS, QNX, WinCE, Nucleus, VxWorks, Haiku, MorphOS, and Mac OS X. It is licensed under either the GNU General Public License or a proprietary license. It is a partial fork of ntfsprogs and is under active maintenance and development.

This piece of software is made available under the terms and conditions of the NTFS-3G Read/Write Driver license, which can be found below.

Source: <http://www.tuxera.com>

WPA Supplicant (0.5.10 & 0.6.7)

These packages are used to provide WiFi access. The

supplier for these tools is Atheros. These pieces of software are made available under the terms and conditions of the GPL v2 license, which can be found below.

This piece of software is made available under the terms and conditions of the WPA Supplicant license, which can be found below.

Source: http://hostap.epitest.fi/wpa_supplicant/

ntfsprogs (2.0.0)

Some useful tool for ntfs file system.

This piece of software is made available under the terms and conditions of the ntfsprogs license, which can be found below.

Source: <http://sourceforge.net/projects/linux-ntfs>

fuse (2.8.4)

Fuse is a simple interface for userspace programs to export a virtual filesystem to the linux kernel.

This piece of software is made available under the terms and conditions of the fuse license, which can be found below.

Source: <http://fuse.sourceforge.net/>

libiconv (1.11.1)

This library provides an iconv() implementation, for use on systems which don't have one, or whose implementation cannot convert from/to Unicode. .

This piece of software is made available under the terms and conditions of the libiconv license, which can be found below.

Source: <http://ftp.gnu.org/pub/gnu/libiconv>

electric-fence (2.1.13)

Used for memory corruption detection.

This piece of software is made available under the terms and conditions of the electric-fence license, which can be found below.

Source: http://perens.com/FreeSoftware/ElectricFence/electric-fence_2.1.13-0.1.tar.gz

liveMedia

When Wifi Display or streaming RtspPlayer are enabled.

This piece of software is made available under the terms and conditions of the electric-fence license, which can be found below.

Source: www.live555.com

QT (4.7.0)

Netflix skype besttv pandora picasa? will use QT.

This piece of software is made available under the terms and conditions of the QT license, which can be found below.

Source: <http://qt.nokia.com/>

e2fsprogs (1.41.14)

e2fsprogs provides the filesystem utilities for use with the ext2 filesystem, it also supports the ext3 and ext4 filesystems.

This piece of software is made available under the terms and conditions of the e2fsprogs license, which can be found below.

Source: <http://e2fsprogs.sourceforge.net/>

alsa (1.0.24.1)

Advanced Linux Sound Architecture (ALSA).

This piece of software is made available under the terms and conditions of the alsa license, which can be found below.

Source: <http://www.alsa-project.org>

lvm2 (2.02.89)

DM_VERITY.

This piece of software is made available under the terms and conditions of the lvm2 license, which can be found below.

Source:

<ftp://sources.redhat.com/pub/lvm2/releases/>

encfs (1.3.2)

A library provides an encrypted filesystem in user-space.

Source: <http://www.arg0.net/encfs>

boost (1.15.0)

A library provides free peer-reviewed portable C++ source libraries is used for encfs.

Source: <http://www.boost.org>

rlog (1.4)

A library that provides a flexible message logging facility for C programs and libraries is used for encfs.

Source: <http://www.arg0.net/rlog>

iptables (1.4.15)

For Cross connection.

Source: <http://www.netfilter.org/projects/iptables/>

bash (3.2.48)

Bash is the shell, or command language interpreter, that will appear in the GNU operating system.

Bash is an sh-compatible shell that incorporates useful features from the Korn shell (ksh) and C shell (csh).

It is intended to conform to the IEEE POSIX P1003.2/ISO 9945.2 Shell and Tools standard.

It offers functional improvements over sh for both programming and interactive use.

In addition, most sh scripts can be run by Bash without modification.

Source: <http://www.gnu.org/software/bash/>

coreutils (6.9)

The GNU Core Utilities are the basic file, shell and text manipulation utilities of the GNU operating system.

These are the core utilities which are expected to exist on every operating system.

Source: <http://www.gnu.org/software/coreutils/>

findutils (4.2.31)

The GNU Find Utilities are the basic directory searching utilities of the GNU operating system.

These programs are typically used in conjunction with other programs to provide modular and powerful directory search and file locating capabilities to other commands.

Source: <http://www.gnu.org/software/findutils/>

gawk (3.1.5)

If you are like many computer users, you would frequently like to make changes in various text files wherever certain patterns appear, or extract data from parts of certain lines while discarding the rest.

To write a program to do this in a language such as C or Pascal is a time-consuming inconvenience that may take many lines of code.

The job is easy with awk, especially the GNU implementation: gawk.

Source: <http://www.gnu.org/software/gawk/>

grep (2.5.1a)

The grep command searches one or more input files for lines containing a match to a specified pattern. By default, grep prints the matching lines.

Source: <http://www.gnu.org/software/grep/>

gzip (1.3.12)

GNU Gzip is a popular data compression program originally written by Jean-loup Gailly for the GNU project. Mark Adler wrote the decompression part.

Source: <http://www.gnu.org/software/gzip/>

inetutils (1.4.2)

Inetutils is a collection of common network programs.

Source: <http://www.gnu.org/software/inetutils/>

iputils (s20101006)

The iputils package is set of small useful utilities for Linux networking. It was originally maintained by Alexey Kuznetsov.

Source: <http://www.skbuff.net/iputils/>

module-init-tools (3.12)

Provides developer documentation for the utilities used by Linux systems to load and manage kernel modules (commonly referred to as "drivers").

Source: https://modules.wiki.kernel.org/index.php/Main_Page

ncurses (5.7)

The Ncurses (new curses) library is a free software emulation of curses in System V Release 4.0, and more.

It uses Terminfo format, supports pads and color and multiple highlights and forms characters and function-key mapping, and has all the other SYSV-curses enhancements over BSD Curses.

Source: <http://www.gnu.org/software/ncurses/>

net-tools (1.6)

The Net-tools package is a collection of programs for controlling the network subsystem of the Linux kernel.

Source: <http://www.linuxfromscratch.org/blfs/view/6.3/basicnet/net-tools.html>

procps (ps, top) (3.2.8)

procps is the package that has a bunch of small useful utilities that give information about processes using the /proc filesystem.

The package includes the programs ps, top, vmstat, w, kill, free, slabtop, and skill.

Source: <http://procps.sourceforge.net/index.html>

psmisc (22.13)

This PSmisc package is a set of some small useful utilities that use the proc filesystem. We're not about changing the world, but providing the system administrator with some help in common tasks.

Source: <http://psmisc.sourceforge.net/>

sed (4.1.5)

sed (stream editor) isn't an interactive text editor.

Instead, it is used to filter text, i.e., it takes text input, performs some operation (or set of operations) on it, and outputs the modified text.

sed is typically used for extracting part of a file using pattern matching or substituting multiple occurrences of a string within a file.

Source: <http://www.gnu.org/software/sed/>

tar (1.17)

GNU Tar provides the ability to create tar archives, as well as various other kinds of manipulation.

For example, you can use Tar on previously created archives to extract files, to store additional files, or to update or list files which were already stored.

Source: <http://www.gnu.org/software/tar/>

util-linux-ng (2.18)

Various system utilities.

Source: <http://userweb.kernel.org/~kzak/util-linux-ng/>

udhcpc (0.9.8cvs20050303-3)

Udhcpc is a very small DHCP client geared towards embedded systems.

Source: <http://udhcp.sourceforge.com/downloads/0.9.8cvs20050303-3/>

Libxml2 (2.7.8)

The "libxml2" library is used in AstroTV as a support for the execution of NCL application. This library was developed for the GNOME software suite and is available under a "MIT" license.

Source: <http://www.xmlsoft.org>

uriparser (0.7.7)

For MPEG-DASH

Source: <http://uriparser.sourceforge.net/>

xerces-c++ (3.1.1)

For MPEG-DASH

Source: <http://xerces.apache.org/>

webp (0.2.1)

For Netflix

Source: <https://code.google.com/p/webp/>

wget (1.10.2)

GNU Wget is a free software package for retrieving files using HTTP, HTTPS and FTP, the most widely-used Internet protocols.

It is a non-interactive commandline tool, so it may easily be called from scripts, cron jobs, terminals without X-Windows support, etc.

Source:

<http://ftp.gnu.org/gnu/wget/wget-1.10.2.tar.gz>

wireless_tools (0.29)

The Wireless Tools (WT) is a set of tools allowing to manipulate the Wireless Extensions.

They use a textual interface and are rather crude, but aim to support the full Wireless Extension.

Source: http://www.hpl.hp.com/personal/Jean_Tourrilhes/Linux/Tools.html

ezxml (0.8.6)

ezXML is a C library for parsing XML documents. Used inside Philips libraries.

Source: <http://sourceforge.net/projects/ezxml/>

SQLite (3.7.7.1)

SQLite is a in-process library that implements a self-contained, serverless, zero-configuration, transactional SQL database engine.

Source: <http://www.sqlite.org/download.html>

AES (aes-src-29-04-09.zip)

Advanced Encryption Standard (AES) is a specification for the encryption of electronic data. Used inside Philips libraries.

Source: <http://gladman.plushost.co.uk/oldsite/AES/>

microhttpd (libmicrohttpd-0.9.9.tar.gz)

GNU libmicrohttpd is a small C library that is supposed to make it easy to run an HTTP server as part of another application.

The original download site for this software is :

<http://www.gnu.org/software/libmicrohttpd/>This piece of software is made available under the terms and conditions of the LGPL v2.1 license

Source: <http://ftp.gnu.org/gnu/libmicrohttpd/libmicrohttpd-0.9.9.tar.gz>

yajl (lloyd-yajl-2.0.1-0-gf4b2b1a.tar.gz)

YAJL is a small event-driven (SAX-style) JSON parser written in ANSI C, and a small validating JSON generator. YAJL is released under the ISC license.

The original download site for this software is :
<http://lloyd.github.com/yajl/>This piece of software is made available under the terms and conditions of the ISC license

Source: <http://pkgs.fedoraproject.org/repo/pkgs/yajl/lloyd-yajl-2.0.1-0-gf4b2b1a.tar.gz/df6a751e7797b9c2182efd91b5d64017/lloyd-yajl-2.0.1-0-gf4b2b1a.tar.gz>

HMAC-SHA1 (0.1)

keyed-hash message authentication code (HMAC) is a specific construction for calculating a message authentication code (MAC) involving a cryptographic hash function in combination with a secret cryptographic key.

As with any MAC, it may be used to simultaneously verify both the data integrity and the authentication of a message.

Any cryptographic hash function, such as MD5 or SHA-1, may be used in the calculation of an HMAC; the resulting MAC algorithm is termed HMAC-MD5 or HMAC-SHA1 accordingly.

Source:

http://www.deadhat.com/wlancrypto/hmac_sha1.c

gSoap (2.7.15)

The gSOAP toolkit is an open source C and C++ software development toolkit for SOAP/XML Web services and generic (non-SOAP) C/C++ XML data bindings.

Part of the software embedded in this product is gSOAP software. Portions created by gSOAP are Copyright 2000-2011 Robert A. van Engelen, Genivia inc. All Rights Reserved.

Source: <http://sourceforge.net/projects/gsoap2/>

jQuery (1.10.2)

jQuery is a fast and concise JavaScript Library that simplifies HTML document traversing, event handling, animating, and Ajax interactions for rapid web development.

Source: <http://jquery.com/>

Libupnp (1.2.1)

The Linux* SDK for UPnP* Devices (libupnp) provides developers with an API and open source code for building control points, devices, and bridges that are compliant with Version 1.0 of the UPnP Device Architecture Specification.

Source: <http://upnp.sourceforge.net/>

mDNSResponder (mDNSResponder-320.10.80)

The mDNSResponder project is a component of Bonjour, Apple's ease-of-use IP networking initiative:<<http://developer.apple.com/bonjour/>> In our project, Bonjour is used for the automatic discovery of devices and services

Source: <http://developer.apple.com/bonjour/AcknowledgementsandLicenseTextsforanyopensource>

software used in this Philips TV.

This is a document describing the distribution of the source code used on the Philips TV, which fall either under the GNU General Public License (the GPL), or the GNU Lesser General Public License (the LGPL), or any other open source license. Instructions to obtain source code for this software can be found in the user manual.

PHILIPS MAKES NO WARRANTIES WHATSOEVER, EITHER EXPRESS OR IMPLIED, INCLUDING ANY WARRANTIES OF MERCHANTABILITY OR FITNESS FOR A PARTICULAR PURPOSE, REGARDING THIS SOFTWARE. Philips offers no support for this software. The preceding does not affect your warranties and statutory rights regarding any Philips product(s) you purchased. It only applies to this source code made available to you.

Freetype (2.4.3)

FreeType is a software font engine that is designed to be small, efficient, highly customizable, and portable while capable of producing high-quality output (glyph images).

This piece of software is made available under the terms and conditions of the FreeType Project license, which can be found below.

Source: <http://freetype.sourceforge.net>

zlib (1.2.3)

The 'zlib' compression library provides in-memory compression and decompression functions, including integrity checks of the uncompressed data.

This piece of software is made available under the terms and conditions of the zlib license, which can be found below.

Source: <http://www.zlib.net/>

Fraunhofer AAC Ecnoder (3.3.3)

AAC Ecnoder.

Source: Android JB source code

unicode (3.2)

This library is used to perform UNICODE string manipulation.

This piece of software is made available under the terms and conditions of the ICU license, which can be found below.

Source: <http://www.icu-project.org/>

libpng (1.2.43)

PNG decoder.

This piece of software is made available under the terms and conditions of the libpng license, which can be found below.

Source: <http://www.libpng.org/pub/png/libpng.html>

libjpg (6b)

This library is used to perform JPEG decoding tasks.

This piece of software is made available under the terms and conditions of the libjpeg license, which can be found below.

Source: <http://www.ijg.org/>

libmng (1.0.10)

libmng - THE reference library for reading, displaying, writing and examining Multiple-Image Network Graphics. MNG is the animation extension to the popular PNG image-format.

This piece of software is made available under the terms and conditions of the libmng license, which can be found below.

Source:

<http://sourceforge.net/projects/libmng/files/>

u-Boot loader (1.3.4)

Used by boot loader and only linked with boot loader, GPL license.

This piece of software is made available under the terms and conditions of the u-Boot loader license, which can be found below.

Source: <http://sourceforge.net/projects/u-boot/files/u-boot/U-Boot-1.1.4/u-boot-1.1.4.tar.bz2/download>

Libcurl (7.21.7)

HTTP client; libcurl is a free and easy-to-use client-side URL transfer library, supporting FTP, FTPS, HTTP, HTTPS, SCP, SFTP, TFTP, TELNET, DICT, LDAP, LDAPS, FILE, IMAP, SMTP, POP3 and RTSP. libcurl supports SSL certificates, HTTP POST, HTTP PUT, FTP uploading, HTTP form based upload, proxies, cookies, user+password authentication (Basic, Digest, NTLM, Negotiate, Kerberos4), file transfer resume, http proxy tunneling and more!

This piece of software is made available under the terms and conditions of the Libcurl license, which can be found below.

Source: <http://curl.haxx.se/>

c-ares (1.7.4)

c-ares is a C library that performs DNS requests and name resolves asynchronously.

This piece of software is made available under the terms and conditions of the c-ares license, which can be found below.

Source: <http://c-ares.haxx.se/c-ares-1.7.1.tar.gz>

openssl (1.0.0d)

OpenSSL is an open source implementation of the SSL and TLS protocols. The core library (written in the C programming language) implements the basic cryptographic functions and provides various utility functions. Wrappers allowing the use of the OpenSSL library in a variety of computer languages are available.

This piece of software is made available under the terms and conditions of the 1.7.4 license, which can be found below.

Source:

<http://www.openssl.org/source/openssl-1.0.0.tar.gz>

Expat (2.01)

xml parser; Expat is an XML parser library written in C. It is a stream-oriented parser in which an application registers handlers for things the parser might find in the XML document (like start tags). An introductory article on using.

This piece of software is made available under the terms and conditions of the Expat license, which can be found below.

Source: <http://expat.sourceforge.net/>

DirectFB include SAWMAN (1.4.0)

It is a software library for GNU/Linux/UNIX based operating system with a small memory footprint that provides graphics acceleration, input device handling and abstraction layer, and integrated windowing system with support for translucent windows and multiple display layers on top of the Linux framebuffer without requiring any kernel modifications.

This piece of software is made available under the terms and conditions of the DirectFB license, which can be found below.

Source: http://sourceforge.net/projects/jointspace/files/remote_applications_SDK/remote_applications_SDK_v1.3.1/DirectFB141_source_1.3.1.7z/download

SAWMAN

SquashFS is a compressed read-only file system for Linux. SquashFS compresses files, inodes and directories, and supports block sizes up to 1 MB for greater compression. SquashFS is also the name of free/open software, licensed under the GPL, for accessing SquashFS filesystems.

Source: <http://squashfs.sourceforge.net/>

Linux Kernel (3.0)

The Linux kernel is an operating system kernel used by the Linux family of Unix-like operating systems.

This piece of software is made available under the terms and conditions of the Linux Kernel license, which can be found below.

Source: <http://www.kernel.org>

SQLite (3.7.2)

SQLite is a in-process library that implements a self-contained, serverless, zero-configuration, transactional SQL database engine.

This piece of software is made available under the terms and conditions of the SQLite license, which can be found below.

Source: <http://www.sqlite.org/download.html>

SquashFS (3.4)

SquashFS is a compressed read-only file system for Linux. SquashFS compresses files, inodes and directories, and supports block sizes up to 1 MB for greater compression. SquashFS is also the name of

free/open software, licensed under the GPL, for accessing SquashFS filesystems. This piece of software is made available under the terms and conditions of the SquashFS license, which can be found below.
Source: <http://squashfs.sourceforge.net/>

glibc (2.6.1)
Any Unix-like operating system needs a C library: the library which defines the "system calls" and other basic facilities such as open, malloc, printf, exit...The GNU C library is used as the C library in the GNU system and most systems with the Linux kernel. This piece of software is made available under the terms and conditions of the glibc license, which can be found below.
Source: <http://www.gnu.org/software/libc/>

mtd-utils (1)
The aim of the system is to make it simple to provide a driver for new hardware, by providing a generic interface between the hardware drivers and the upper layers of the system. Hardware drivers need to know nothing about the storage formats used, such as FTL, FFS2, etc., but will only need to provide simple routines for read, write and erase. Presentation of the device's contents to the user in an appropriate form will be handled by the upper layers of the system. This piece of software is made available under the terms and conditions of the mtd-utils license, which can be found below.
Source: <http://www.linux-mtd.infradead.org/index.html>

libusb (1.0.6)
This is the home of libusb, a library that gives user level applications uniform access to USB devices across many different operating systems. libusb is an open source project licensed under the GNU Lesser General Public License version 2.1. Many participants in the libusb community have helped and continue to help with ideas, implementation, support and improvements for libusb. This piece of software is made available under the terms and conditions of the libusb license, which can be found below.
Source:
<http://libusb.wiki.sourceforge.net>
<http://www.libusb.org/>

libusb-compat (0.1.3)
Library to enable user space application programs to communicate with USB devices. This piece of software is made available under the terms and conditions of the libusb-compat license, which can be found below.
Source:
<http://libusb.wiki.sourceforge.net/LibusbCompat0.1>

NTFS-3G Read/Write Driver (2010.5.22)

NTFS-3G is an open source cross-platform implementation of the Microsoft Windows NTFS file system with read-write support. NTFS-3G often uses the FUSE file system interface, so it can run unmodified on many different operating systems. It is runnable on Linux, FreeBSD, NetBSD, OpenSolaris, BeOS, QNX, WinCE, Nucleus, VxWorks, Haiku, MorphOS, and Mac OS X. It is licensed under either the GNU General Public License or a proprietary license. It is a partial fork of ntfsprogs and is under active maintenance and development. This piece of software is made available under the terms and conditions of the NTFS-3G Read/Write Driver license, which can be found below.
Source: <http://www.tuxera.com>

WPA Supplicant (0.5.10 & 0.6.7)
These packages are used to provide WiFi access. The supplier for these tools is Atheros. These pieces of software are made available under the terms and conditions of the GPL v2 license, which can be found below. This piece of software is made available under the terms and conditions of the WPA Supplicant license, which can be found below.
Source: http://hostap.epitest.fi/wpa_supplicant/

ntfsprogs (2.0.0)
Some useful tool for ntfs file system. This piece of software is made available under the terms and conditions of the ntfsprogs license, which can be found below.
Source: <http://sourceforge.net/projects/linux-ntfs>

fuse (2.8.4)
Fuse is a simple interface for userspace programs to export a virtual filesystem to the linux kernel. This piece of software is made available under the terms and conditions of the fuse license, which can be found below.
Source: <http://fuse.sourceforge.net/>

libiconv (1.11.1)
This library provides an iconv() implementation, for use on systems which don't have one, or whose implementation cannot convert from/to Unicode. . This piece of software is made available under the terms and conditions of the libiconv license, which can be found below.
Source: <http://ftp.gnu.org/pub/gnu/libiconv>

electric-fence (2.1.13)
Used for memory corruption detection. This piece of software is made available under the terms and conditions of the electric-fence license, which can be found below.
Source: http://perens.com/FreeSoftware/ElectricFence/electric-fence_2.1.13-0.1.tar.gz

liveMedia

When Wifi Display or streaming RtspPlayer are enabled.

This piece of software is made available under the terms and conditions of the electric-fence license, which can be found below.

Source: www.live555.com

QT (4.7.0)

Netflix skype besttv pandora picasa? will use QT.

This piece of software is made available under the terms and conditions of the QT license, which can be found below.

Source: <http://qt.nokia.com/>

e2fsprogs (1.41.14)

e2fsprogs provides the filesystem utilities for use with the ext2 filesystem, it also supports the ext3 and ext4 filesystems.

This piece of software is made available under the terms and conditions of the e2fsprogs license, which can be found below.

Source: <http://e2fsprogs.sourceforge.net/>

alsa (1.0.24.1)

Advanced Linux Sound Architecture (ALSA).

This piece of software is made available under the terms and conditions of the alsa license, which can be found below.

Source: <http://www.alsa-project.org>

lvm2 (2.02.89)

DM_VERITY.

This piece of software is made available under the terms and conditions of the lvm2 license, which can be found below.

Source:

<ftp://sources.redhat.com/pub/lvm2/releases/>

encfs (1.3.2)

A library provides an encrypted filesystem in user-space.

Source: <http://www.arg0.net/encfs>

boost (1.15.0)

A library provides free peer-reviewed portable C++ source libraries is used for encfs.

Source: <http://www.boost.org>

rlog (1.4)

A library that provides a flexible message logging facility for C programs and libraries is used for encfs.

Source: <http://www.arg0.net/rlog>

iptables (1.4.15)

For Cross connection.

Source: <http://www.netfilter.org/projects/iptables/>

bash (3.2.48)

Bash is the shell, or command language interpreter, that will appear in the GNU operating system.

Bash is an sh-compatible shell that incorporates useful features from the Korn shell (ksh) and C shell (csh).

It is intended to conform to the IEEE POSIX P1003.2/ISO 9945.2 Shell and Tools standard.

It offers functional improvements over sh for both programming and interactive use.

In addition, most sh scripts can be run by Bash without modification.

Source: <http://www.gnu.org/software/bash/>

coreutils (6.9)

The GNU Core Utilities are the basic file, shell and text manipulation utilities of the GNU operating system.

These are the core utilities which are expected to exist on every operating system.

Source: <http://www.gnu.org/software/coreutils/>

findutils (4.2.31)

The GNU Find Utilities are the basic directory searching utilities of the GNU operating system.

These programs are typically used in conjunction with other programs to provide modular and powerful directory search and file locating capabilities to other commands.

Source: <http://www.gnu.org/software/findutils/>

gawk (3.1.5)

If you are like many computer users, you would frequently like to make changes in various text files wherever certain patterns appear, or extract data from parts of certain lines while discarding the rest.

To write a program to do this in a language such as C or Pascal is a time-consuming inconvenience that may take many lines of code.

The job is easy with awk, especially the GNU implementation: gawk.

Source: <http://www.gnu.org/software/gawk/>

grep (2.5.1a)

The grep command searches one or more input files for lines containing a match to a specified pattern. By default, grep prints the matching lines.

Source: <http://www.gnu.org/software/grep/>

gzip (1.3.12)

GNU Gzip is a popular data compression program originally written by Jean-loup Gailly for the GNU project. Mark Adler wrote the decompression part.

Source: <http://www.gnu.org/software/gzip/>

inetutils (1.4.2)

Inetutils is a collection of common network programs.

Source: <http://www.gnu.org/software/inetutils/>

iputils (s20101006)

The iputils package is set of small useful utilities for Linux networking. It was originally maintained by Alexey Kuznetsov.

Source: <http://www.skbuff.net/iputils/>

module-init-tools (3.12)

Provides developer documentation for the utilities used by Linux systems to load and manage kernel modules (commonly referred to as "drivers").

Source: https://modules.wiki.kernel.org/index.php/Main_Page

ncurses (5.7)

The Ncurses (new curses) library is a free software emulation of curses in System V Release 4.0, and more.

It uses Terminfo format, supports pads and color and multiple highlights and forms characters and function-key mapping, and has all the other SYSV-curses enhancements over BSD Curses.

Source: <http://www.gnu.org/software/ncurses/>

net-tools (1.6)

The Net-tools package is a collection of programs for controlling the network subsystem of the Linux kernel.

Source: <http://www.linuxfromscratch.org/blfs/view/6.3/basicnet/net-tools.html>

procps (ps, top) (3.2.8)

procps is the package that has a bunch of small useful utilities that give information about processes using the /proc filesystem.

The package includes the programs ps, top, vmstat, w, kill, free, slabtop, and skill.

Source: <http://procps.sourceforge.net/index.html>

psmisc (22.13)

This PSmisc package is a set of some small useful utilities that use the proc filesystem. We're not about changing the world, but providing the system administrator with some help in common tasks.

Source: <http://psmisc.sourceforge.net/>

sed (4.1.5)

sed (stream editor) isn't an interactive text editor. Instead, it is used to filter text, i.e., it takes text input, performs some operation (or set of operations) on it, and outputs the modified text.

sed is typically used for extracting part of a file using pattern matching or substituting multiple occurrences of a string within a file.

Source: <http://www.gnu.org/software/sed/>

tar (1.17)

GNU Tar provides the ability to create tar archives, as well as various other kinds of manipulation.

For example, you can use Tar on previously created archives to extract files, to store additional files, or to update or list files which were already stored.

Source: <http://www.gnu.org/software/tar/>

util-linux-ng (2.18)

Various system utilities.

Source: <http://userweb.kernel.org/~kzak/util-linux-ng/>

udhcp (0.9.8cvs20050303-3)

Udhcp is a very small DHCP client geared towards embedded systems.

Source: <http://udhcp.sourceforge.com/downloads/0.9.8cvs20050303-3/>

Libxml2 (2.7.8)

The "libxml2" library is used in AstroTV as a support for the execution of NCL application. This library was developed for the GNOME software suite and is available under a "MIT" license.

Source: <http://www.xmlsoft.org>

uriparser (0.7.7)

For MPEG-DASH

Source: <http://uriparser.sourceforge.net/>

xerces-c++ (3.1.1)

For MPEG-DASH

Source: <http://xerces.apache.org/>

webp (0.2.1)

For Netflix

Source: <https://code.google.com/p/webp/>

wget (1.10.2)

GNU Wget is a free software package for retrieving files using HTTP, HTTPS and FTP, the most widely-used Internet protocols.

It is a non-interactive commandline tool, so it may easily be called from scripts, cron jobs, terminals without X-Windows support, etc.

Source:

<http://ftp.gnu.org/gnu/wget/wget-1.10.2.tar.gz>

wireless_tools (0.29)

The Wireless Tools (WT) is a set of tools allowing to manipulate the Wireless Extensions.

They use a textual interface and are rather crude, but aim to support the full Wireless Extension.

Source: http://www.hpl.hp.com/personal/Jean_Tourrilhes/Linux/Tools.html

ezxml (0.8.6)

ezXML is a C library for parsing XML documents. Used inside Philips libraries.

Source: <http://sourceforge.net/projects/ezxml/>

SQLite (3.7.7.1)

SQLite is a in-process library that implements a self-contained, serverless, zero-configuration, transactional SQL database engine.

Source: <http://www.sqlite.org/download.html>

AES (aes-src-29-04-09.zip)

Advanced Encryption Standard (AES) is a

specification for the encryption of electronic data.
Used inside Philips libraries.
Source: <http://gladman.plushost.co.uk/oldsite/AES/>

microhttpd (libmicrohttpd-0.9.9.tar.gz)
GNU libmicrohttpd is a small C library that is supposed to make it easy to run an HTTP server as part of another application.
The original download site for this software is :
<http://www.gnu.org/software/libmicrohttpd/>This piece of software is made available under the terms and conditions of the LGPL v2.1 license
Source: <http://ftp.gnu.org/gnu/libmicrohttpd/libmicrohttpd-0.9.9.tar.gz>

yajl (lloyd-yajl-2.0.1-0-gf4b2b1a.tar.gz)
YAJL is a small event-driven (SAX-style) JSON parser written in ANSI C, and a small validating JSON generator. YAJL is released under the ISC license.
The original download site for this software is :
<http://lloyd.github.com/yajl/>This piece of software is made available under the terms and conditions of the ISC license
Source: <http://pkgs.fedoraproject.org/repo/pkgs/yajl/lloyd-yajl-2.0.1-0-gf4b2b1a.tar.gz/df6a751e7797b9c2182efd91b5d64017/lloyd-yajl-2.0.1-0-gf4b2b1a.tar.gz>

HMAC-SHA1 (0.1)
keyed-hash message authentication code (HMAC) is a specific construction for calculating a message authentication code (MAC) involving a cryptographic hash function in combination with a secret cryptographic key.
As with any MAC, it may be used to simultaneously verify both the data integrity and the authentication of a message.
Any cryptographic hash function, such as MD5 or SHA-1, may be used in the calculation of an HMAC; the resulting MAC algorithm is termed HMAC-MD5 or HMAC-SHA1 accordingly.
Source:
http://www.deadhat.com/wlancrypto/hmac_sha1.c

gSoap (2.7.15)
The gSOAP toolkit is an open source C and C++ software development toolkit for SOAP/XML Web services and generic (non-SOAP) C/C++ XML data bindings.
Part of the software embedded in this product is gSOAP software. Portions created by gSOAP are Copyright 2000-2011 Robert A. van Engelen, Genivia inc. All Rights Reserved.
Source: <http://sourceforge.net/projects/gsoap2/>

jquery (1.10.2)
jQuery is a fast and concise JavaScript Library that simplifies HTML document traversing, event handling, animating, and Ajax interactions for rapid web development.

Source: <http://jquery.com/>

Libupnp (1.2.1)
The Linux* SDK for UPnP* Devices (libupnp) provides developers with an API and open source code for building control points, devices, and bridges that are compliant with Version 1.0 of the UPnP Device Architecture Specification.
Source: <http://upnp.sourceforge.net/>

mDNSResponder (mDNSResponder-320.10.80)
The mDNSResponder project is a component of Bonjour, Apple's ease-of-use IP networking initiative:<<http://developer.apple.com/bonjour/>>
In our project, Bonjour is used for the automatic discovery of devices and services
Source: <http://developer.apple.com/bonjour/>

Specifications

22.1

Environmental

European Energy Label

The European Energy Label informs you on the energy efficiency class of this product. The greener the energy efficiency class of this product is, the lower the energy it consumes.

On the label, you can find the energy efficiency class, the average power consumption of this product in use and the average energy consumption for 1 year. You can also find the power consumption values for this product on the Philips website for your country at www.philips.com/TV

Product Fiche

43PUx6101

- Energy Efficiency Class : A+
- Visible Screen Size : 108 cm / 43 inch
- On Mode Power Consumption (W) : 47 W
- Annual Energy Consumption (kWh) * : 68 kWh
- Standby Power Consumption (W) **: 0.30 W
- Off Mode Power Consumption (W) : Not applicable
- Display Resolution (Pixels) : 3840 x 2160p

49PUx6101

- Energy Efficiency Class : A+
- Visible Screen Size : 123 cm / 49 inch
- On Mode Power Consumption (W) : 66 W
- Annual Energy Consumption (kWh) * : 96 kWh
- Standby Power Consumption (W) **: 0.30 W
- Off Mode Power Consumption (W) : Not applicable
- Display Resolution (Pixels) : 3840 x 2160p

55PUx6101

- Energy Efficiency Class : A+
- Visible Screen Size : 139 cm / 55 inch
- On Mode Power Consumption (W) : 62 W
- Annual Energy Consumption (kWh) * : 91 kWh
- Standby Power Consumption (W) **: 0.30 W
- Off Mode Power Consumption (W) : Not applicable
- Display Resolution (Pixels) : 3840 x 2160p

* Energy consumption kWh per year, based on the power consumption of the television operating 4 hours per day for 365 days. The actual energy consumption depends on how the television is used.

** When the TV is turned off with the remote control and no function is active.

End of use

Disposal of your old product and batteries

Your product is designed and manufactured with high quality materials and components, which can be recycled and reused.



When this crossed-out wheeled bin symbol is attached to a product it means that the product is covered by the European Directive 2012/19/EU.



Please inform yourself about the local separate collection system for electrical and electronic products.

Please act according to your local rules and do not dispose of your old products with your normal household waste. Correct disposal of your old product helps to prevent potential negative consequences for the environment and human health.

Your product contains batteries covered by the European Directive 2006/66/EC, which cannot be disposed with normal household waste.



Please find out for yourself about the local rules on separate collection of batteries because correct disposal will help to prevent negative consequences for the environment and human health.

22.2

Power

Product specifications are subject to change without notice. For more specification details of this product, see www.philips.com/support

Power

- Mains power : AC 220–240V +/-10%
- Ambient temperature : 5°C to 35°C
- Power saving features : Eco mode, Picture mute (for radio), Auto switch-off timer, Eco settings menu.

For power consumption information, see chapter **Product Fiche**.

The power rating stated on the product typeplate is

the power consumption for this product during normal household use (IEC 62087 Ed.2). The maximum power rating, stated between brackets, is used for electrical safety (IEC 60065 Ed. 7.2).

22.3

Reception

- Aerial input : 75 ohm coaxial (IEC75)
- Tuner bands : Hyperband, S-Channel, UHF, VHF
- DVB : DVB-T (terrestrial, antenna) COFDM 2K/8K, DVB-C (cable) QAM
- Analogue video playback : SECAM, PAL
- Digital video playback : MPEG2 SD/HD (ISO/IEC 13818-2), MPEG4 SD/HD (ISO/IEC 14496-10)
- Digital audio playback (ISO/IEC 13818-3)

22.4

Display type

Diagonal screen size

- 43PUx6101 : 108 cm / 43 inch
- 49PUx6101 : 123 cm / 49 inch
- 55PUx6101 : 139 cm / 55 inch

Display resolution

- 3840 x 2160p

22.5

Display input resolution

Video formats

Resolution — Refresh rate

- 480i - 60 Hz
- 480p - 60 Hz
- 576i - 50 Hz
- 576p - 50 Hz
- 720p - 50 Hz, 60 Hz
- 1080i - 50 Hz, 60 Hz
- 1080p - 24 Hz, 25 Hz, 30 Hz
- 2160p - 24 Hz, 25 Hz, 30 Hz, 50 Hz, 60 Hz

Computer formats

Resolutions (amongst others)

- 640 x 480p - 60 Hz
- 800 x 600p - 60 Hz
- 1024 x 768p - 60 Hz
- 1280 x 768p - 60 Hz
- 1360 x 765p - 60 Hz
- 1360 x 768p - 60 Hz
- 1280 x 1024p - 60 Hz
- 1920 x 1080p - 60 Hz
- 3840 x 2160p - 24 Hz, 25 Hz, 30 Hz, 50 Hz, 60 Hz

22.6

Dimensions and Weights

43PUx6101

- without TV stand:
Width 968.2 mm - Height 575.7 mm - Depth 81.8 mm
- Weight ± 9.25 kg

- with TV stand:
Width 968.2 mm - Height 623.3 mm - Depth 201.8 mm - Weight ± 9.73 kg

49PUx6101

- without TV stand:
Width 1099.2 mm - Height 631.9 mm - Depth 86.7 mm - Weight ± 11.03 kg

- with TV stand:
Width 1099.2 mm - Height 699.7 mm - Depth 210.5 mm - Weight ± 11.85 kg

55PUx6101

- without TV stand:
Width 1239.2 mm - Height 724.7 mm - Depth 87.9 mm
- Weight ± 15.5 kg

- with TV stand:
Width 1239.2 mm - Height 779.4 mm - Depth 228.8 mm - Weight ± 16 kg

22.7

Connectivity

TV Side

- HDMI 3 in
- HDMI 4 in - MHL
- USB 2
- USB 3
- 1x Common Interface slot: CI+/CAM
- Headphones - Stereo mini-jack 3.5mm

TV Rear

- Audio In (DVI to HDMI) - Stereo mini-jack 3.5mm
- SCART: Audio L/R, CVBS in, RGB
- CVBS/Y Pb Pr : CVBS/Y Pb Pr, Audio L/R

TV Bottom

- HDMI 1 in - ARC
- HDMI 2 in
- USB 1
- Audio out - Optical Toslink
- Network LAN - RJ45
- Antenna (75 ohm)

22.8

Sound

- HD Stereo
- Output power (RMS) : 16W
- Dolby® Digital Plus
- DTS 2.0+ Digital out™

Multimedia

Connections

- USB 2.0 / USB 3.0
- Ethernet LAN RJ-45
- Wi-Fi 802.11b/g/n (built-in)

Supported USB file systems

- FAT 16, FAT 32, NTFS

Playback formats

- Containers : 3GP, AVCHD, AVI, MPEG-PS, MPEG-TS, MPEG-4, Matroska (MKV), Quicktime (MOV, M4V, M4A), Windows Media (ASF/WMV/WMA)
- Video Codecs : MPEG-1, MPEG-2, MPEG-4 Part 2, MPEG-4 Part 10 AVC (H.264), VC-1, WMV9
- Audio Codecs : AAC, HE-AAC (v1/v2), AMR-NB, Dolby Digital, Dolby Digital Plus, DTS 2.0 + Digital Out™, MPEG-1/2/2.5 Layer I/II/III (includes MP3), WMA (v2 to v9.2), WMA Pro (v9/v10)
- Subtitles :
 - Formats : SAMI, SubRip (SRT), SubViewer (SUB), MicroDVD (TXT), mplayer2 (TXT), TMPlayer (TXT)
 - Character encodings : UTF-8, Central Europe and Eastern Europe (Windows-1250), Cyrillic (Windows-1251), Greek (Windows-1253), Turkish (Windows-1254), Western Europe (Windows-1252)
- Image Codecs : JPEG
- Limitations :
 - Maximum supported total bit rate for a media file is 30Mbps.
 - Maximum supported video bit rate for a media file is 20Mbps.
 - MPEG-4 AVC (H.264) is supported up to High Profile @ L4.1.
 - VC-1 is supported up to Advanced Profile @ L3.

Wi-Fi Certified

This TV supports Miracast certified devices.

Supported media server software (DMS)

- You can use any DLNA V1.5 certified media server software (DMS class).
- You can use the Philips TV Remote app (iOS and Android) on mobile devices.

Performance may vary, depending on the capabilities of the mobile device and the software used.

ESD regulations

This apparatus meets performance criteria A for ESD. In case the apparatus does not recover in file sharing mode due to electrostatic discharge, user interference is required.

Help and support

23.1

Register your TV



Register your TV and enjoy a range of benefits including full support (including downloads), privileged access to information about new products, exclusive offers and discounts, the chance to win prizes and even participate in special surveys about new releases.

Go to www.philips.com/welcome

23.2

Using help

Open Help

Press the  key (blue) to open Help immediately. Help will open on the chapter that is most relevant to what you are doing or what is selected on TV. To look up topics alphabetically, press the colour key  **Keywords**.

To read the Help as a book, select **Book**.

Before you execute the Help instructions, close Help. To close Help, press the colour key  **Close**.

For some activities, like Text (Teletext), the colour keys have specific functions and cannot open Help.

TV Help on your tablet, smartphone or computer

To carry out extended sequences of instructions more easily, you can download the TV Help in PDF format to read on your smartphone, tablet or computer. Alternatively, you can print the relevant Help page from your computer.

To download the Help (user manual) go to www.philips.com/support

23.3

Troubleshooting

Switch on and remote control

The TV does not switch on

- Disconnect the power cable from the power outlet. Wait for one minute then reconnect it.
- Make sure that the power cable is securely connected.

Creaking sound at startup or switch off

When you are turning the TV on, off or to standby, you hear a creaking sound from the TV chassis. The

creaking sound is due to the normal expansion and contraction of the TV as it cools and warms up. This does not affect performance.

TV does not respond to the remote control

The TV requires some time to start up. During this time, the TV does not respond to the remote control or TV controls. This is normal behaviour.

If the TV continues to be unresponsive to the remote control, you can check if the remote control is working by means of a mobile phone camera. Put the phone in camera mode and point the remote control to the camera lens. If you press any key on the remote control and you notice the infra red LED flicker through the camera, the remote control is working. The TV needs to be checked.

If you do not notice the flickering, the remote control might be broken or its batteries are low.

This method of checking the remote control is not possible with remote controls which are wirelessly paired with the TV.

The TV goes back to standby after showing the Philips startup screen

When the TV is in standby, a Philips startup screen is displayed, then the TV returns to standby mode. This is normal behaviour. When the TV is disconnected and reconnected to the power supply, the startup screen is displayed at the next startup. To switch on the TV from standby, press on the remote control or the TV.

The standby light keeps on blinking

Disconnect the power cable from the power outlet. Wait 5 minutes before you reconnect the power cable. If the blinking reoccurs, contact Philips TV Consumer Care.

Channels

No digital channels found during the installation

See the technical specifications to make sure that your TV supports DVB-T or DVB-C in your country. Make sure that all cables are properly connected and that the correct network is selected.

Previously installed channels are not in the channel list

Make sure that the correct channel list is selected.

Picture

No picture / distorted picture

- Make sure that the antenna is properly connected to the TV.
- Make sure that the correct device is selected as the display source.
- Make sure that the external device or source is properly connected.

Sound but no picture

- Make sure that the picture settings are set correctly.

Poor antenna reception

- Make sure that the antenna is properly connected to the TV.
- Loud speakers, unearthed audio devices, neon lights, high buildings and other large objects can influence reception quality. If possible, try to improve the reception quality by changing the antenna direction or moving devices away from the TV.
- If reception on only one channel is poor, fine-tune this channel with Manual Installation.

Poor picture from a device

- Make sure that the device is connected properly.
- Make sure that the picture settings are set correctly.

Picture settings change after a while

Make sure that **Location** is set to **Home**. You can change and save settings in this mode.

A commercial banner appears

Make sure that **Location** is set to **Home**.

Picture does not fit the screen

Change to a different picture format.

Picture format keeps changing with different channels

Select a non 'Auto' picture format.

Picture position is incorrect

Picture signals from some devices may not fit the screen correctly. Check the signal output of the connected device.

Computer picture is not stable

Make sure that your PC uses the supported resolution and refresh rate.

Sound

No sound or poor sound quality

If no audio signal is detected, the TV automatically switches the audio output off — this does not indicate malfunction.

- Make sure that the sound settings are correctly set.
- Make sure that all cables are properly connected.

- Make sure that the volume is not muted or set to zero.
- Make sure that the TV audio output is connected to the audio input on the Home Theatre System. Sound should be heard from the HTS speakers.
- Some devices may require you to manually enable HDMI audio output. If HDMI audio is already enabled, but you still do not hear audio, try changing the digital audio format of the device to PCM (Pulse Code Modulation). Refer to the documentation accompanying your device for instructions.

HDMI and USB

HDMI

- Note that HDCP (High-bandwidth Digital Content Protection) support can delay the time taken for a TV to display content from an HDMI device.
- If the TV does not recognise the HDMI device and no picture is displayed, switch the source from one device to another and back again.
- If the picture and sound of a device connected with HDMI is distorted, check if a different **HDMI Ultra HD** setting can solve this problem. In Help, press the colour key  **Keywords** and look up **HDMI Ultra HD**.
- If there are intermittent sound disruptions, make sure that output settings from the HDMI device are correct.
- If you use an HDMI-to-DVI adapter or HDMI-to-DVI cable, make sure that an additional audio cable is connected to AUDIO IN (mini-jack only), if available.

HDMI EasyLink does not work

- Make sure that your HDMI devices are HDMI-CEC compatible. EasyLink features only work with devices that are HDMI-CEC compatible.

No volume icon shown

- When an HDMI-CEC audio device is connected and you use the TV Remote Control to adjust the volume level from the device, this behaviour is normal.

Photos, videos and music from a USB device do not show

- Make sure that the USB storage device is set to Mass Storage Class compliant, as described in the storage device's documentation.
- Make sure that the USB storage device is compatible with the TV.
- Make sure that the audio and picture file formats are supported by the TV.

Choppy playback of USB files

- The transfer performance of the USB storage device may limit the data transfer rate to the TV which causes poor playback.

Wi-Fi and Internet

Wi-Fi network not found or distorted

- Microwave ovens, DECT phones or other Wi-Fi 802.11b/g/n devices in your proximity might disturb the wireless network.
- Make sure that the firewalls in your network allow access to the TV's wireless connection.
- If the wireless network does not work properly in your home, try the wired network installation.

Internet does not work

- If the connection to the router is OK, check the router connection to the Internet.

The PC and Internet connection are slow

- Look in your wireless router's user manual for information on indoor range, transfer rate and other factors of signal quality.
- Use a high-speed (broadband) Internet connection for your router.

DHCP

- If the connection fails, you can check the DHCP (Dynamic Host Configuration Protocol) setting of the router. DHCP should be switched on.

Wrong menu language

Wrong menu language

Change the language back to your language.

To change the language of the TV menus and messages...

- 1 - Press , select **General settings** > **Language** > **Menu Language** and press **OK**.
- 2 - Select on the language you need.
- 3 - Press **◀** (left) repeatedly if necessary, to close the menu.

23.4

Online help

To solve any Philips TV related problem, you can consult our online support. You can select your language and enter your product model number.

Go to www.philips.com/support .

On the support site you can find your country's telephone number to contact us as well as answers to frequently asked questions (FAQs). In some countries, you can chat with one of our collaborators and ask your question directly or send a question by email. You can download new TV software or the manual to read on your computer.

23.5

Consumer care / Repair

For support and repair, call the Consumer Care hotline in your country. Find the telephone number in the printed documentation that came with the TV. Or consult our website www.philips.com/support .

TV model number and serial number

You might be asked to provide the TV product model number and serial number. Find these numbers on the packaging label or on the type label on the back or bottom of the TV.

Warning

Do not attempt to repair the TV yourself. This may cause severe injury, irreparable damage to your TV or void your warranty.

Safety and care

24.1

Safety

Important

Read and understand all safety instructions before you use the TV. If damage is caused by failure to follow instructions, the warranty does not apply.

Secure the TV from falling over

Always use the supplied wall bracket to secure the TV from falling over. Mount the bracket and secure the TV onto the bracket, even if you put the TV on the floor.

You can find the mounting instructions in the Quick Start Guide that came with the TV. In case you lost this guide, you can download the guide from www.philips.com Use the product type number of the TV to look for the Quick Start Guide to download.

Risk of electric shock or fire

- Never expose the TV to rain or water. Never place liquid containers, such as vases, near the TV. If liquids are spilt on or into the TV, disconnect the TV from the power outlet immediately. Contact Philips TV Consumer Care to have the TV checked before use.
- Never expose the TV, remote control or batteries to excessive heat. Never place them near burning candles, naked flames or other heat sources, including direct sunlight.
- Never insert objects into the ventilation slots or other openings on the TV.
- Never place heavy objects on the power cord.
- Avoid force coming onto power plugs. Loose power plugs can cause arcing or fire. Ensure that no strain is exerted on the power cord when you swivel the TV screen.
- To disconnect the TV from the mains power, the power plug of the TV must be disconnected. When disconnecting the power, always pull the power plug, never the cord. Ensure that you have full access to the power plug, power cord and outlet socket at all times.

Risk of injury or damage to the TV

- Two people are required to lift and carry a TV that weighs more than 25 kg or 55 lbs.
- If you mount the TV on a stand, only use the supplied stand. Secure the stand to the TV tightly. Place the TV on a flat, level surface that can support the weight of the TV and the stand.
- When wall mounted, ensure that the wall mount can safely bear the weight of the TV set. TP Vision bears no responsibility for improper wall mounting that results in accident, injury or damage.
- Parts of this product are made of glass. Handle with care to avoid injury or damage.

Risk of damage to the TV !

Before you connect the TV to the power outlet, ensure that the power voltage matches the value printed on the back of the TV. Never connect the TV to the power outlet if the voltage is different.

Risk of injury to children

Follow these precautions to prevent the TV from toppling over and causing injury to children:

- Never place the TV on a surface covered by a cloth or other material that can be pulled away.
- Ensure that no part of the TV hangs over the edge of the mounting surface.
- Never place the TV on tall furniture, such as a bookcase, without anchoring both the furniture and TV to the wall or a suitable support.
- Teach children about the dangers of climbing on furniture to reach the TV.

Risk of swallowing batteries !

The remote control may contain coin-type batteries which can easily be swallowed by small children. Keep these batteries out of reach of children at all times.

Risk of overheating

Never install the TV in a confined space. Always leave a space of at least 10 cm or 4 inches around the TV for ventilation. Ensure curtains or other objects never cover the ventilation slots on the TV.

Lightning storms

Disconnect the TV from the power outlet and antenna before lightning storms.

During lightning storms, never touch any part of the TV, power cord or antenna cable.

Risk of hearing damage

Avoid using earphones or headphones at high volumes or for prolonged periods of time.

Low temperatures

If the TV is transported in temperatures below 5°C or 41°F, unpack the TV and wait until the TV temperature reaches room temperature before connecting the TV to the power outlet.

Humidity

In rare occasions, depending on temperature and humidity, minor condensation can occur on the inside of the TV glass front (on some models). To prevent this, do not expose the TV to direct sunlight, heat or extreme humidity. If condensation occurs, it will disappear spontaneously while the TV is playing for a few hours.

The condensation moisture will not harm the TV or cause malfunction.

24.2

Screen care

- Never touch, push, rub or strike the screen with any object.
- Unplug the TV before cleaning.
- Clean the TV and frame with a soft damp cloth and wipe gently. Never use substances such as alcohol, chemicals or household cleaners on the TV.
- To avoid deformations and colour fading, wipe off water drops as quickly as possible.
- Avoid stationary images as much as possible.

Stationary images are images that remain onscreen for extended periods of time. Stationary images include onscreen menus, black bars, time displays, etc. If you must use stationary images, reduce screen contrast and brightness to avoid screen damage.

Terms of use

2016 © TP Vision Europe B.V. All rights reserved.

This product was brought to the market by TP Vision Europe B.V. or one of its affiliates, hereinafter referred to as TP Vision, which is the manufacturer of the product. TP Vision is the warrantor in relation to the TV with which this booklet was packaged. Philips and the Philips Shield Emblem are registered trademarks of Koninklijke Philips N.V.

Specifications are subject to change without notice. Trademarks are the property of Koninklijke Philips N.V. or their respective owners. TP Vision reserves the right to change products at any time without being obliged to adjust earlier supplies accordingly.

The written material packaged with the TV and the manual stored in the memory of the TV or downloaded from the Philips website www.philips.com/support are believed to be adequate for the intended use of the system.

The material in this manual is believed adequate for the intended use of the system. If the product, or its individual modules or procedures, are used for purposes other than those specified herein, confirmation of their validity and suitability must be obtained. TP Vision warrants that the material itself does not infringe any United States patents. No further warranty is expressed or implied. TP Vision cannot be held responsible neither for any errors in the content of this document nor for any problems as a result of the content in this document. Errors reported to Philips will be adapted and published on the Philips support website as soon as possible.

Terms of warranty - Risk of injury, damage to TV or void of warranty!

Never attempt to repair the TV yourself. Use the TV and accessories only as intended by the manufacturer. The caution sign printed on the back of the TV indicates risk of electric shock. Never remove the TV cover. Always contact Philips TV Customer Care for service or repairs. Find the telephone number in the printed documentation that came with the TV. Or consult our website www.philips.com/support and select your country if needed. Any operation expressly prohibited in this manual, or any adjustments and assembly procedures not recommended or authorised in this manual, shall void the warranty.

Pixel characteristics

This LCD/LED product has a high number of colour pixels. Although it has effective pixels of 99.999% or more, black dots or bright points of light (red, green or blue) may appear constantly on the screen. This is a structural property of the display (within common industry standards) and is not a malfunction.

CE compliance

This product is in compliance with the essential requirements and other relevant provisions of Directives 2006/95/EC (Low Voltage), 2004/108/EC (EMC) and 2011/65/EU (ROHS).

Compliance with EMF

TP Vision manufactures and sells many products targeted at consumers which, like any electronic apparatus, in general have the ability to emit and receive electromagnetic signals. One of TP Vision's leading business principles is to take all necessary health and safety measures for our products, to comply with all applicable legal requirements and to stay well within the Electro Magnetic Field (EMF) standards applicable at the time of producing the products.

TP Vision is committed to developing, producing and marketing products that cause no adverse health effects. TP Vision confirms that, as long as its products are handled properly for their intended use, they are safe to use according to scientific evidence available today. TP Vision plays an active role in the development of international EMF and safety standards, enabling TP Vision to anticipate further developments in standardisation for early integration in its products.

Copyrights

26.1

MHL

MHL, Mobile High-Definition Link and the MHL Logo are trademarks or registered trademarks of the MHL, LLC.



26.2

Ultra HD

The DIGITALEUROPE UHD Display Logo is a trademark of DIGITALEUROPE.



26.3

HDMI

The terms HDMI and HDMI High-Definition Multimedia Interface, and the HDMI Logo are trademarks or registered trademarks of HDMI Licensing LLC in the United States and other countries.



26.4

Dolby Digital Plus

Manufactured under license from Dolby Laboratories. Dolby and the double-D symbol are trademarks of Dolby Laboratories.



26.5

DTS 2.0 + Digital Out™

Manufactured under license under U.S. Patent Nos: 5,956,674; 5,974,380; 6,487,535 and other U.S. and worldwide patents issued and pending. DTS, the Symbol, and DTS and the Symbol together are registered trademarks and DTS 2.0+Digital Out is a trademark of DTS, Inc. Product includes software. © DTS, Inc. All Rights Reserved.



26.6

DTV_i

The DTV_i brand and logo are registered marks of Pontifical Catholic University of Rio de Janeiro (PUC-Rio) and the Federal University of Paraíba (UFPB).

26.7

Java

Java and all Java based trademarks are registered trademarks of Oracle and/or its affiliates, in the United States and other countries.

26.8

Microsoft

Windows Media

Windows Media is either a registered trademark or trademark of Microsoft Corporation in the United States and/or other countries.



Microsoft PlayReady

Content owners use Microsoft PlayReady™ content access technology to protect their intellectual property, including copyrighted content.

This device uses PlayReady technology to access PlayReady-protected content and/or WMDRM-protected content. If the device fails to properly enforce restrictions on content usage, content owners may require Microsoft to revoke the device's ability to consume PlayReady-protected content. Revocation should not affect unprotected content or content protected by other content access technologies. Content owners may require you to upgrade PlayReady to access their content. If you decline an upgrade, you will not be able to access content that requires the upgrade.

26.9

Wi-Fi Alliance

Wi-Fi®, the Wi-Fi CERTIFIED logo, the Wi-Fi logo are registered trademarks of the Wi-Fi Alliance.



26.10

Kensington

Kensington and Micro Saver are registered US trademarks of ACCO World Corporation with issued registrations and pending applications in other countries throughout the world.



26.11

MHEG software

The copyright in MHEG software ("the Software") comprised in this television ("this product") and included to enable you to use interactive television features is owned by S&T CLIENT SYSTEMS LIMITED ("the Owner"). You are permitted to use the Software only in conjunction with this product.

26.12

Other trademarks

All other registered and unregistered trademarks are the property of their respective owners.

Index

A

- Age Rating 28
- Antenna connection 7
- Antenna, Manual Installation 68
- App gallery 47
- Audio commentary 63
- Audio Description 63
- Audio Language 29
- Audio Language, Primary 29
- Audio Language, Secondary 29
- Audio Out - Optical, tips 15
- Audio Out Delay 17
- Audio Out Format 18
- Audio Out Levelling 18
- Audio Out Offset 18
- Audio Out Settings 17
- Audio to Video Sync 17
- Auto Volume Levelling 55
- Automatic Channel Update 66
- Automatic switch off 24

B

- Backlight Contrast 52
- Bass 55
- Blu-ray Disc player, connect 18

C

- Cable, Manual Installation 68
- CAM PIN 16
- CAM, Conditional Access Module 15
- Camcorder, connect 22
- Channel 27
- Channel List 27
- Channel List Copy 68
- Channel List Copy, copy 68
- Channel List Copy, upload 69
- Channel List, about 27
- Channel List, filter 27
- Channel List, open 27
- Channel logos 59
- Channel Update Message 66
- Channel, age rating 28
- Channel, Antenna installation 66
- Channel, Automatic Channel Update 66
- Channel, Cable Installation 66
- Channel, Manual channel update 66
- Channel, Options 28
- Channel, Reinstall 66
- Channel, switch to a channel 28
- Channel, TV guide 33
- Child Lock 60
- CI+ 15
- Clear Internet Memory 10
- Clear Miracast connection 10
- Clear Sound 56
- Clock settings 62
- Colour 52
- Colour, Colour enhancement 52
- Colour, colour temperature 52
- Colour, custom colour temperature 53
- Common Interface Slot 15
- Computer, connect 22

- Connect, USB Flash Drive 22
- Connectivity Guide 12
- Consumer Care 87
- Contact Philips 87
- Contrast 52
- Contrast, Contrast Mode 53
- Contrast, Dynamic Contrast 53
- Contrast, Gamma 53
- Contrast, Video Contrast 53

D

- Digital Text 30
- Disposal of TV or batteries 82
- DMR, Digital Media Renderer 9
- DVB (Digital Video Broadcast) 66
- DVD player 19

E

- EasyLink 13
- EasyLink, On or Off 13
- EasyLink, Remote control 13
- EasyLink, settings 14
- Eco settings 57
- End of use 82
- European Ecolabel 82

F

- Frequency Scan 67
- Frequency Step Size 67

G

- Game Console, connect 19
- Game or Computer 40
- Game or Computer, setting 52
- Gamma 53

H

- Hard of hearing 63
- HbbTV 31
- HDMI MHL 12
- HDMI Ultra HD 58
- HDMI, ARC 12
- HDMI, DVI connection 14
- Headphones Volume 57
- Headphones, connect 19
- Hearing impaired 63
- Home Menu 37
- Home Theatre System, Multichannel 18
- Home Theatre System, problems 18
- Home Theatre System, volume levelling 18

I

- Incredible Surround 55
- Interactive TV 31
- Interactive TV, about 31

I

- iTV 31

K

- Keys on TV 24

L

- Language settings 60

M

- Media 42
- Media files, from a computer or NAS 42
- Media files, from a USB drive 42
- Miracast™, switch on 44
- Motion, Natural Motion 54
- MPEG Artefact Reduction 54

N

- Natural Motion 54
- Network Frequency 67
- Network Frequency Mode 67
- Network installation 8
- Network, Clear Wi-Fi Miracast connection 10
- Network, connect 8
- Network, problem 8
- Network, settings 9
- Network, static IP 9
- Network, Switch on Wi-Fi 10
- Network, TV Network Name 10
- Network, view settings 9
- Network, Wi-Fi Smart Screen 10
- Network, wired 9
- Network, wireless 8
- Network, WoWLAN 9
- Network, WPS 8
- Network, WPS with PIN code 8
- Noise Reduction 54

O

- On a TV stand, TV Placement 57
- On the wall, TV Placement 57
- Online support 87
- Open Source software 71
- Options on a Channel 28

P

- Parental Rating 28
- Partially sighted 63
- Pause TV 36
- Photo camera, connect 22
- Photos, videos and music 42
- Picture Format 54
- Picture Format, advanced 54
- Picture Format, basic 54
- Picture Style 51
- Picture, Backlight Contrast 52
- Picture, Colour 52
- Picture, Sharpness 52
- Pixel Plus link 14
- Placement, TV placement 6
- Placement, viewing distance 6
- Power connection 6
- Problems 85
- Problems, Channels 85
- Problems, Connection, HDMI 86
- Problems, Connection, Internet 87
- Problems, Connection, USB 86
- Problems, Connection, Wi-Fi 87
- Problems, Menu language 87
- Problems, Picture 86
- Problems, Remote control 85
- Problems, Sound 86
- Product Fiche 82

R

- Radio stations 27

- Reception Quality 67
- Recording 35
- Recording, TV Guide data 33
- Register your product 85
- Reinstall TV 66
- Remote control and batteries 26
- Rental videos 47
- Repair 87

S

- Safety instructions 88
- SCART connection, tips 15
- Screen care 89
- Sharpness 52
- Sharpness, MPEG Artefact Reduction 54
- Sharpness, Noise reduction 54
- Sharpness, Ultra Resolution 54
- Sleep Timer 24
- Smart Card, CAM 15
- Smart TV 45
- Software, Update 70
- Sound Style 55
- Sound, Auto Volume Levelling 55
- Sound, Bass 55
- Sound, Clear Sound 56
- Sound, Headphones Volume 57
- Sound, surround mode 55
- Sound, Treble 55
- Subtitle 29
- Subtitle Language 29
- Subtitle Language, Primary 29
- Subtitle Language, Secondary 29
- Support, online 87
- Surround Mode 55
- Switch off timer 24
- Switching on 24
- Synchronise Audio and Video 17

T

- Teletext 30
- Terms of Use 90
- Test Reception 67
- Text 30
- Text language, Primary 31
- Text language, Secondary 31
- Treble 55
- TV Guide 33
- TV Guide, data and information 33
- TV Guide, Reminder 34
- TV Installation 66

U

- Universal access 63
- Universal access, Hard of hearing 63
- Universal Access, Speakers/Headphones 63
- USB Hard Drive, disk space 20
- USB Hard Drive, Installation 20
- USB Keyboard 21
- USB Keyboard, connect 21

V

- Video Selection 29
- Visually impaired 63

W

- Watch TV 28
- Wi-Fi 8
- Wired network 9

Wireless network 8

WoWLAN 9

Y

YPbPr connection, tips 14



www.philips.com/support

Հայաստան - Armenia
Հաճախորդների սպասարկում
0 800 01 004
փոխանցված 0,03€/ min

Azərbaycan - Azerbaijan
Müştəri xidmətləri
088 220 00 04
Köçürüldü zəng edin 0,17€/min

България
Грижа за клиента
02 4916 273
(Национален номер)

België/Belgique
Klantenservice/
Service Consommateurs
02 700 72 62
(0.15€/min.)

Bosna i Hercegovina
Potpora potrošačima
033 941 251
(Lokalni poziv)

Republika Srbija Potpora
potrošačima
011 321 6840
(Lokalni poziv)

Česká republika
Zákaznická podpora
228 880 895
(Místní tarif)

Danmark
Kundeservice
3525 8314

Deutschland
Kundendienst
069 66 80 10 10
(Zum Festnetzstarif Ihres
Anbieters)

Ελλάδα
Τμήμα καταναλωτών
2111983028
(Διεθνής κλήση)

Eesti
Klienditugi
668 30 61
(Kohalikud kõned)

España
Atención al consumidor
913 496 582
(0,10€ + 0,08€/min.)

France
Service Consommateurs
01 57 32 40 50
(coût d'un appel local sauf
surcoût éventuel selon opérateur
réseau)

Hrvatska
Potpora potrošačima
01 777 66 01
(Lokalni poziv)

Indonesia
Consumer Care
0800 133 3000

Ireland
Consumer Care
015 24 54 45
(National Call)

Italia
Servizio Consumatori
0245 28 70 14
(Chiamata nazionale)

Қазақстан Республикасы
байланыс орталығы
810 800 2000 00 04
(стационарлық нөмірлерден
Қазақстан Республикасы бойынша
қоңырау шалу тегін)

Latvija
Klientu atbalsts
6616 32 63
(Vietēlais tarifs)

Lietuva
Klientų palaikymo tarnyba
8 521 402 93
(Vietinai tarifais)

Luxembourg
Service Consommateurs
2487 11 00
(Appel nat./ (Nationale Ruf)

Magyarország
Ügyfélszolgálat
(061) 700 81 51
(Belföldi hívás)

Malaysia
Consumer Care
1800 220 180

Nederland
Klantenservice
0900 202 08 71
(1€/gesprek)

Norge
Forbrukerstotte
22 97 19 14

Österreich
Kundendienst
0150 284 21 40
(0,05€/Min.)

Республика Беларусь
Контакт Центр
8 10 (800) 2000 00 04
(бесплатный звонок по
Республике Беларусь со
стационарных номеров)

Российская Федерация
Контакт Центр
8 (800) 220 00 04
(бесплатный звонок по России)

Polska
Wsparcie Klienta
22 397 15 04
(Połączenie lokalne)

Portugal
Assistência a clientes
800 780 068
(0,03€/min. – Móvel 0,28€/min.)

România
Serviciul Clienti
031 630 00 42
(Tarif local)

Schweiz/Suisse/Svizzera
Kundendienst/Service
Consommateurs/Servizio
Consumatori
0848 000 291
(0,04 CHF/Min)

Slovenija
Skrb za potrošnike
01 88 88 312
(Lokalni klic)

Slovensko
Zákaznická podpora
02 332 154 93
(vnútroštátny hovor)

Suomi
Finland Kuluttajapalvelu
09 88 62 50 40

Sverige
Kundtjänst
08 57 92 90 96

Türkiye
Tüketici Hizmetleri
0 850 222 44 66

Україна
Служба підтримки
споживачів
0-800-500-480
(дзвінки зі стаціонарних і
мобільних телефонів у межах
України безкоштовні)

Кыргызстан
Байланыш борбору
810 800 2000 00 04

United Kingdom
Consumer Care
020 79 49 03 19
(5p/min BT landline)



All registered and unregistered trademarks are property of their respective owners. Specifications are subject to change without notice. Philips and the Philips' shield emblem are trademarks of Koninklijke Philips N.V. and are used under license from Koninklijke Philips N.V. 2016 © TP Vision Europe B.V. All rights reserved.

philips.com