

TV

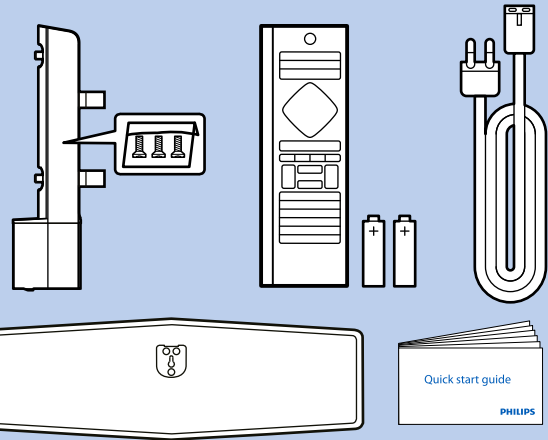

Register your product and get support at  
[www.philips.com/welcome](http://www.philips.com/welcome)

6551 series

**PHILIPS**



**English** - Read the safety instructions.

**Български** - Прочетете инструкциите за безопасност.

**Čeština** - Přečtěte si bezpečnostní pokyny.

**Hrvatski** - Pročitajte sigurnosne upute.

**Dansk** - Læs sikkerhedsforskrifterne.

**Deutsch** - Lesen Sie die Sicherheitshinweise.

**Ελληνικά** - Διαβάστε τις οδηγίες ασφαλείας.

**Eesti** - Lugege ohutusnõudeid.

**Español** - Lea las instrucciones de seguridad.

**Français** - Lisez les consignes de sécurité.

**Gaeilge** - Léigh na teoracha sábháilteachta.

**Bahasa Indonesia** - Baca petunjuk keselamatan.

**Italiano** - Leggere le istruzioni di sicurezza.

**Казакша** - Қорғаныстық нұсқаулар.

**Latviešu** - Izlasiet drošības norādījumus.

**Lietuvių** - Perskaitykite saugos instrukcijas.

**Македонски** - Прочитајте ги безбедносните инструкции.

**Magyar** - Olvassa el a biztonsági utasításokat.

**Bahasa Malaysia** - Baca arahan keselamatan.

**Nederlands** - Lees de veiligheidsvoorschriften.

**Norsk** - Les sikkerhetsforskriftene.

**Polski** - Zapoznaj się z instrukcjami bezpieczeństwa.

**Português** - Leia as instruções de segurança.

**Română** - Citiți instrucțiunile de siguranță.

**Русский** - Читайте инструкции по технике безопасности.

**Srpski** - Pročitajte bezbednosna uputstva.

**Slovenščina** - Preberite varnostna navodila.

**Slovenský** - Prečítajte si bezpečnostné pokyny.

**Suomi** - Lue turvaohjeet.

**Svenska** - Läs säkerhetsinstruktionerna.

**ภาษาไทย** - โปรดอ่านคำแนะนำด้านความปลอดภัย

**Türkçe** - Güvenlik talimatlarını okuyun.

**Українська** - Читайте інструкції з техніки безпеки.

**Кыргызча** - Коопсуздук техникасы боюнча нускаманы окуңуз.

**Tiếng Việt** - Hãy đọc chỉ dẫn an toàn.

**简体中文** - 请阅读安全说明。

**繁體中文** - 請閱讀安全說明。

**العربية** قراءة تعليمات السلامة.

**עברית** קראו את הוראות הבטיחות

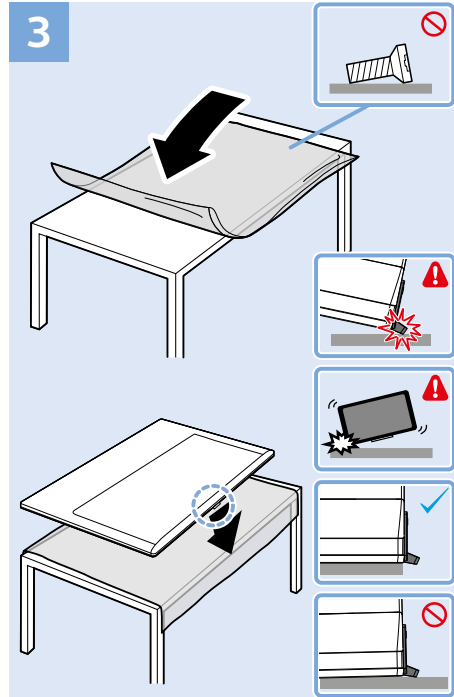
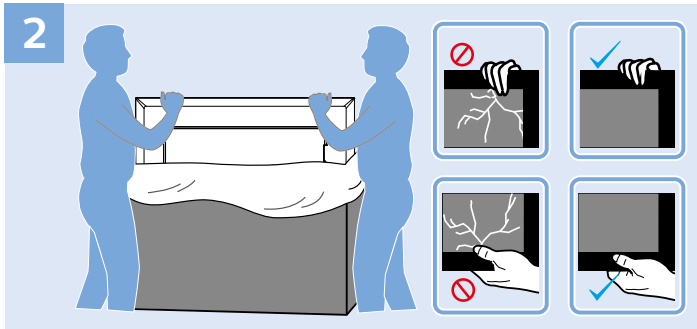
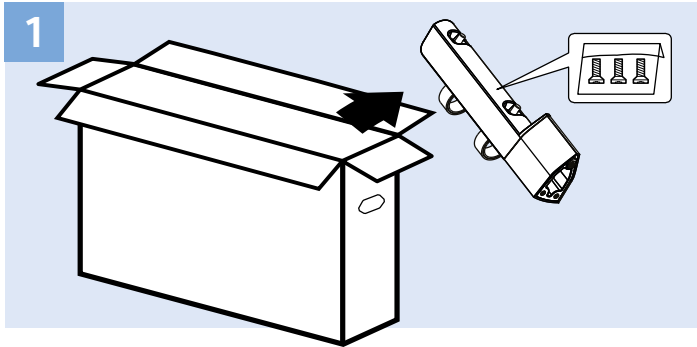
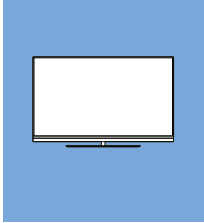

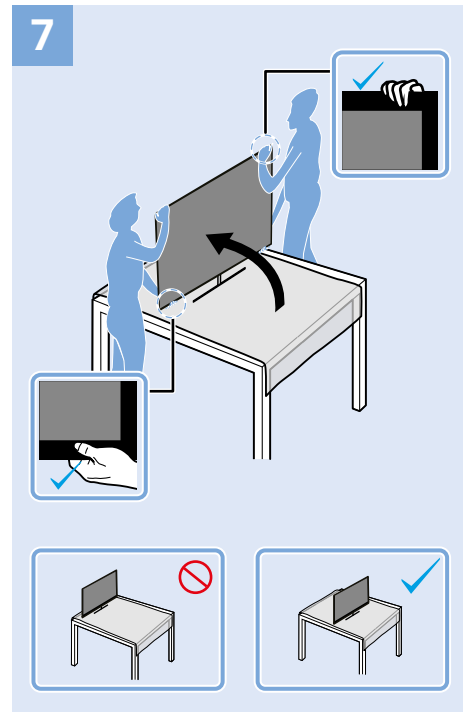
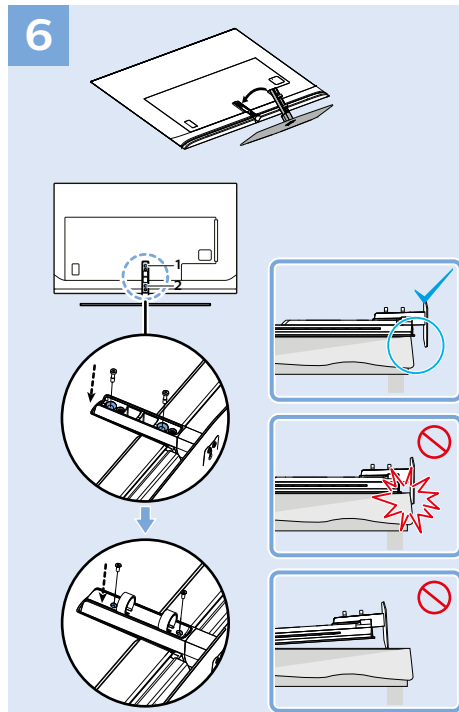
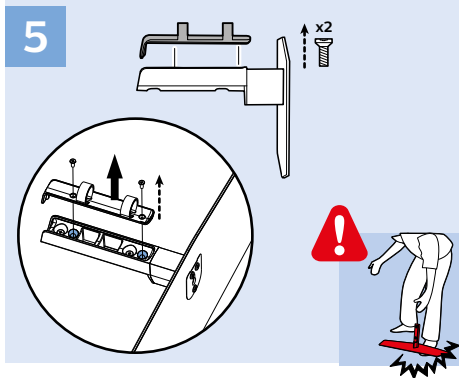
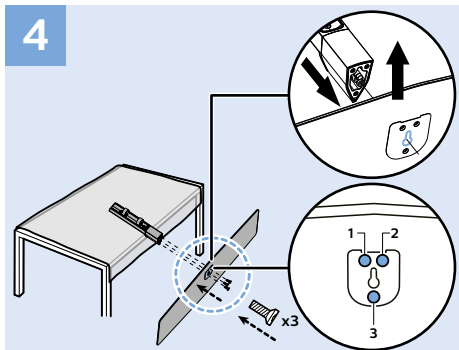

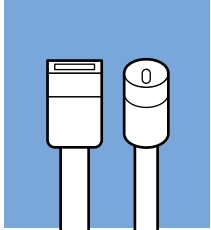

[www.philips.com/connectivityguide](http://www.philips.com/connectivityguide)

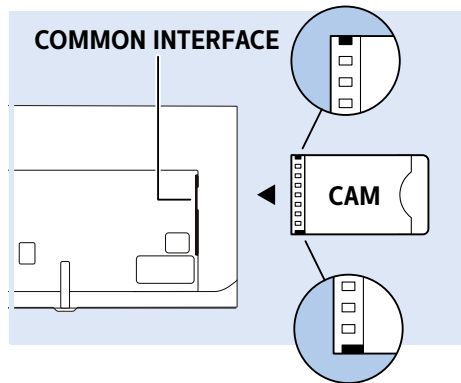
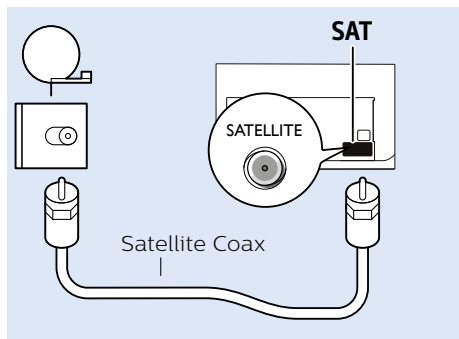
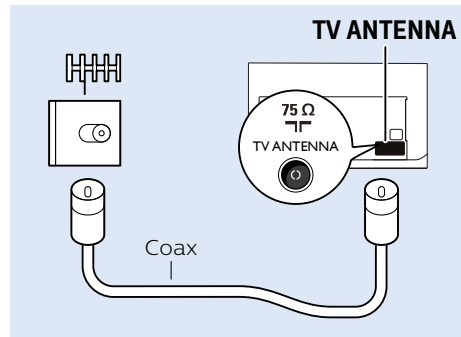
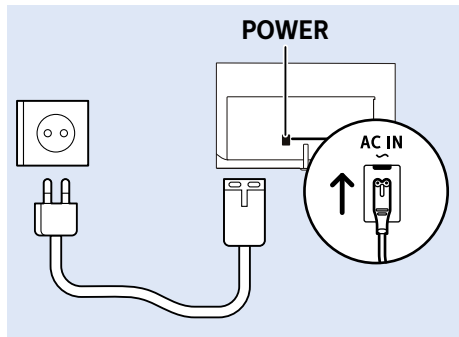

## Network - Wireless

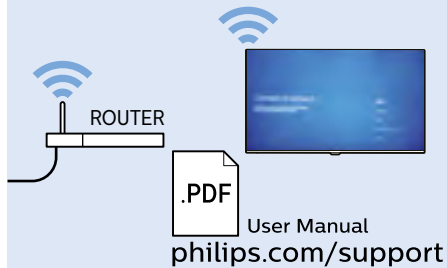

## Network - Wired

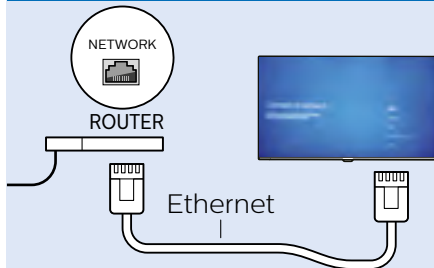

## Set top box/Multimedia Player(UHD source)

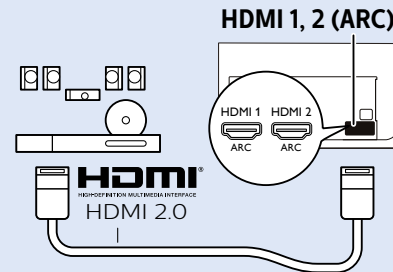

## Set top box/Multimedia Player(FHD source)

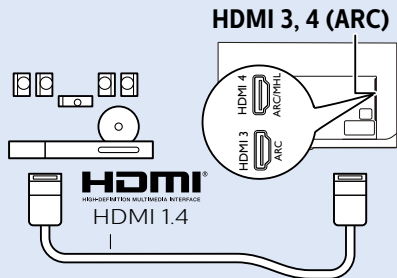

## Home Theatre System - Audio

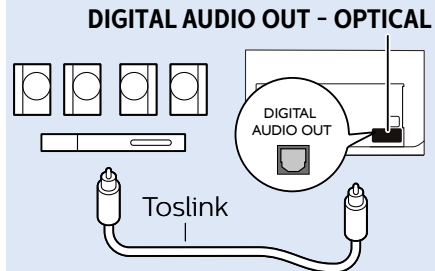

## Video Player

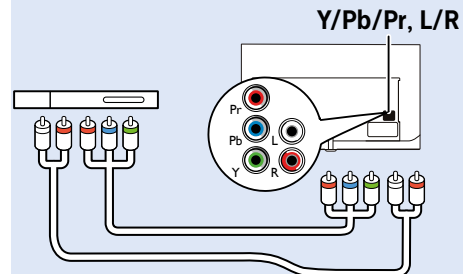

## USB Hard Drive

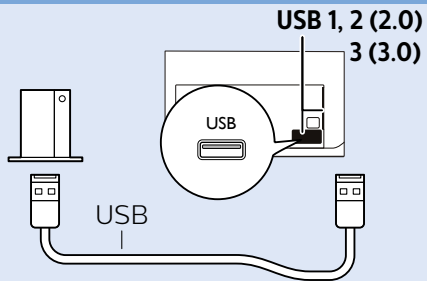

## Headphones

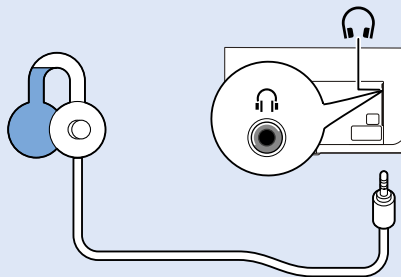

## DVD Player

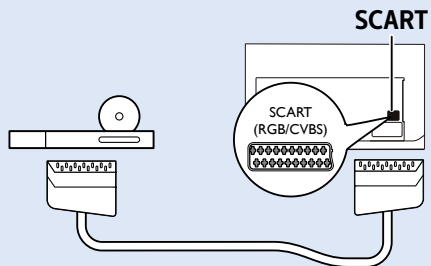

## MHL

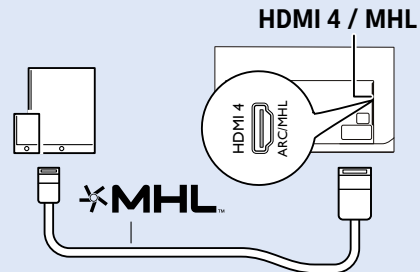

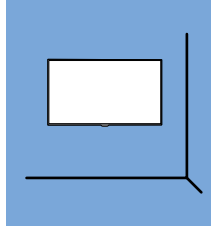
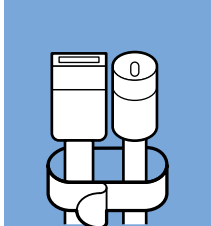

VESA (x, y)  
43" 200x200 M6  
49"/55" 400x200 M6

43"

49"

55"

108cm

123cm

139cm

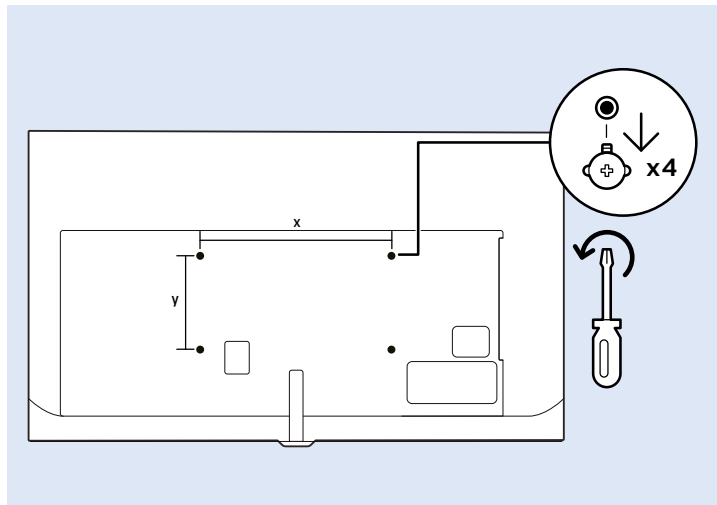
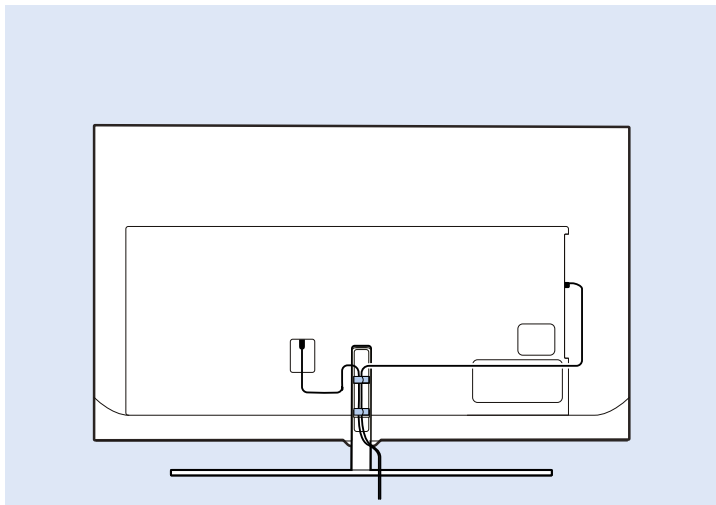



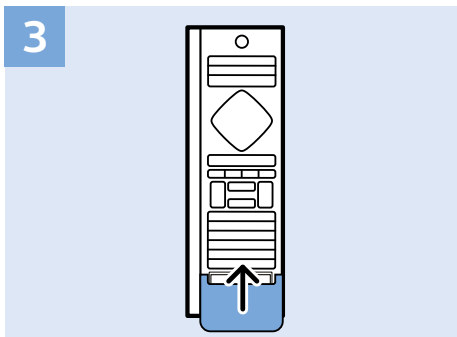
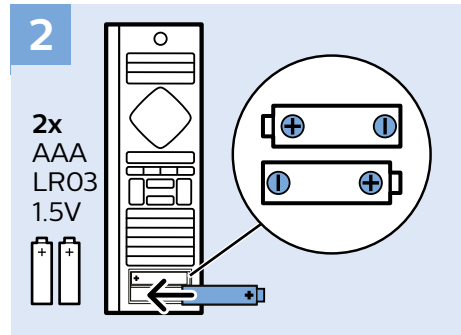
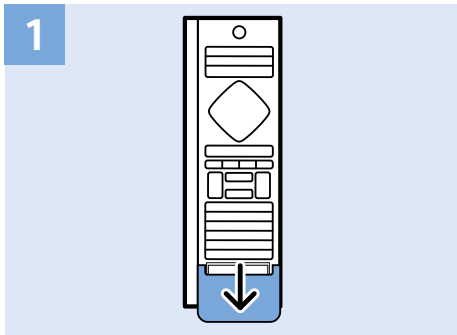
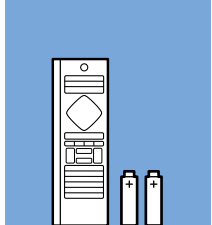

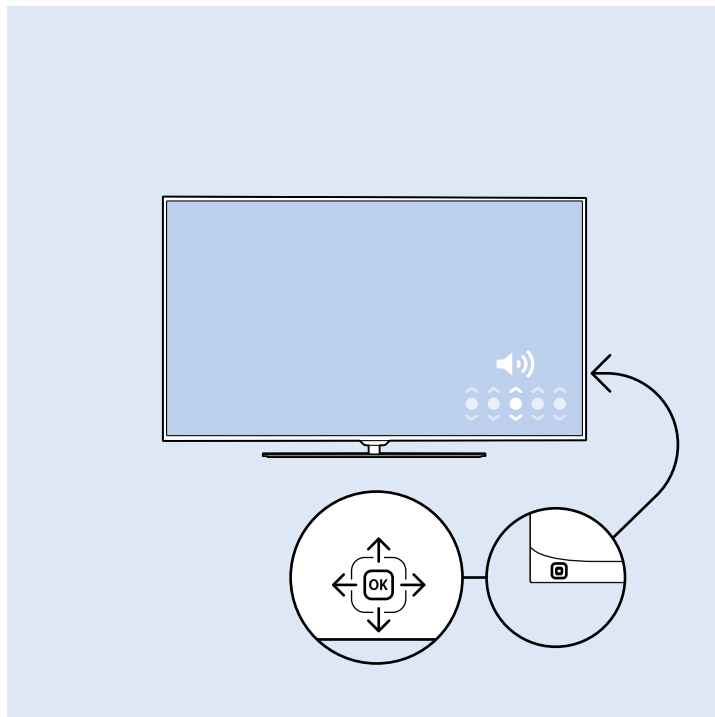
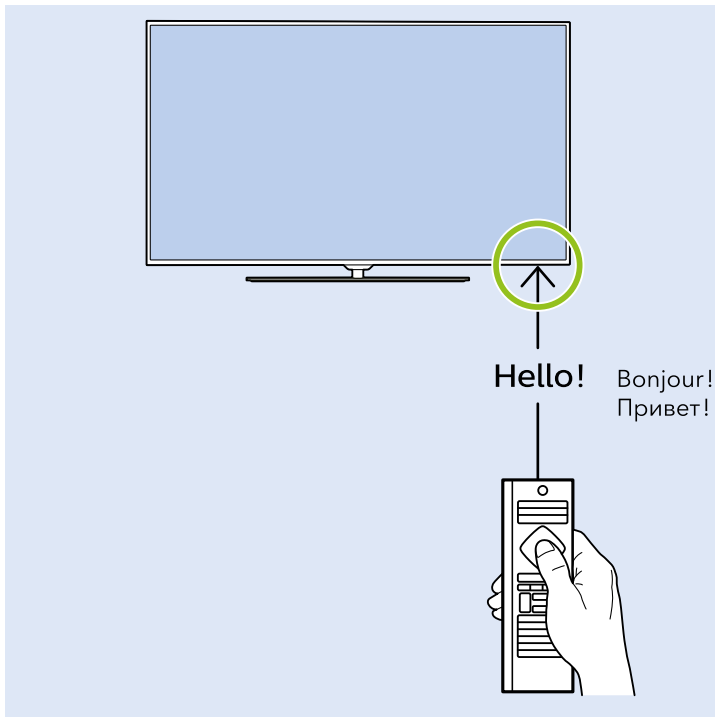



Help | Hilfe | Aide  
Guida | Ayuda  
Pomoc | Yardım  
Руководство

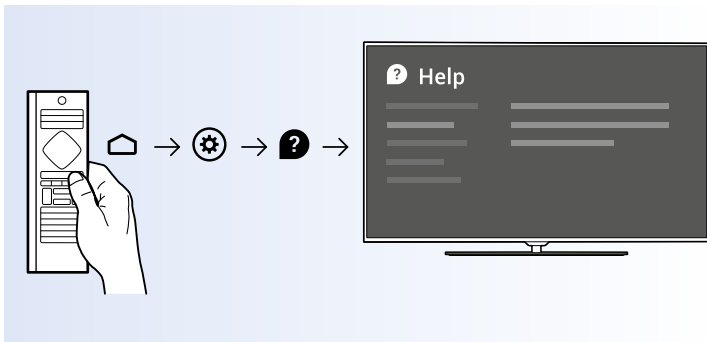

[philips.com/support](https://philips.com/support)

6551 Series  
User Manual

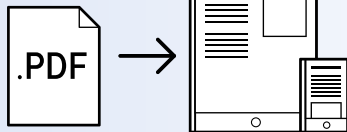

**Հայաստան – Armenia**  
Հաճախորդների սպասարկում  
**0 800 01 004**  
փոխանցված 0,03€/ min

**Azərbaycan – Azerbaijan**  
Müştəri xidmətləri  
**088 220 00 04**  
Köçürüldü zəng edin 0,17€/min

**Кыргызстан**  
Байланыш борбору  
**810 800 2000 00 04**

**България**  
Грижа за клиента  
**02 4916 273**  
(Национален номер)

**België/Belgique**  
Klantenservice/  
Service Consommateurs  
**02 700 72 62**  
(0.15€/min.)

**Bosna i Hercegovina**  
Potpora potrošačima  
**033 941 251**  
(Lokalni poziv)

**Republika Srbija** Potpora  
potrošačima  
**011 321 6840**  
(Lokalni poziv)

**Česká republika**  
Zákaznická podpora  
**228 880 895**  
(Místní tarif)

**Danmark**  
Kundeservice  
**3525 8314**

**Deutschland**  
Kundendienst  
**069 66 80 10 10**  
(Zum Festnetztarif Ihres  
Anbieters)



[www.philips.com/support](http://www.philips.com/support)

← A - I

**Ελλάδα**  
Τμήμα καταναλωτών  
**2111983028**  
(Διεθνής κλήση)

**Eesti**  
Klienditugi  
**668 30 61**  
(Kohalikud kõned)

**España**  
Atencion al consumidor  
**913 496 582**  
(0,10€ + 0,08€/min.)

**France**  
Service Consommateurs  
**01 57 32 40 50**  
(coût d'un appel local sauf surcoût éventuel selon opérateur réseau)



All registered and unregistered trademarks are property of their respective owners. Specifications are subject to change without notice. Philips and the Philips' shield emblem are trademarks of Koninklijke Philips N.V. and are used under license from Koninklijke Philips N.V.  
2016 © TP Vision Europe B.V. All rights reserved.

[philips.com](http://philips.com)

**Қазақстан Республикасы**  
байланыс орталығы  
**810 800 2000 00 04**  
(стационарлық нөмірлерден  
Қазақстан Республикасы бойынша  
қырырау шалу тегін)

**Hrvatska**  
Potpora potrošačima  
**01 777 66 01**  
(Lokalni poziv)

**Indonesia**  
Consumer Care  
**0800 133 3000**

**Ireland**  
Consumer Care  
**015 24 54 45**  
(National Call)

**Italia**  
Servizio Consumatori  
**0245 28 70 14**  
(Chiamata nazionale)

**Latvija**  
Klientu atbalsts  
**6616 32 63**  
(Vietēlais tarifs)

**Lietuva**  
Klientų palaikymo tarnyba  
**8 521 402 93**  
(Vietiniais tarifais)

**Luxembourg**  
Service Consommateurs  
**2487 11 00**  
(Appel nat./ (Nationale Ruf)

**Magyarország**  
Ügyfélszolgálat  
**(061) 700 81 51**  
(Belföldi hívás)

**Malaysia**  
Consumer Care  
**1800 220 180**

**Österreich**  
Kundendienst  
**0150 284 21 40**  
(0,05€/Min.)

**Республика Беларусь**  
Контакт Центр  
**8 10 (800) 2000 00 04**  
(бесплатный звонок по  
Республике Беларусь со  
стационарных номеров)

**Российская Федерация**  
Контакт Центр  
**8 (800) 220 00 04**  
(бесплатный звонок по России)

**Polska**  
Wsparcie Klienta  
**22 397 15 04**  
(Połączenie lokalne)

**Nederland**  
Klantenservice  
**0900 202 08 71**  
(1€/gesprek)

**Norge**  
Forbrukerstotte  
**22 97 19 14**

**Slovenija**  
Skrb za potrošnike  
**01 88 88 312**  
(Lokalni klic)

**Slovensko**  
Zákaznícka podpora  
**02 332 154 93**  
(vnútroštátny hovor)

**Suomi**  
Finland Kuluttajapalvelu  
**09 88 62 50 40**

**Portugal**  
Assistência a clientes  
**800 780 068**  
(0,03€/min. – Móvel 0,28€/min.)

**România**  
Serviciul Clienti  
**031 630 00 42**  
(Tarif local)

**Schweiz/Suisse/Svizzera**  
Kundendienst/Service  
Consommateurs/Servizio  
Consumatori  
**0848 000 291**  
(0,04 CHF/Min)

**Sverige**  
Kundtjänst  
**08 57 92 90 96**

**Türkiye**  
Tüketici Hizmetleri  
**0 850 222 44 66**

**Україна**  
Служба підтримки  
споживачів  
**0-800-500-480**  
(дзвінки зі стационарних і  
мобільних телефонів у межах України  
безкоштовні)

**United Kingdom**  
Consumer Care  
**020 79 49 03 19**  
(5p/min BT landline)

**Argentina**  
Consumer Care  
**0800 444 77 49**  
- Buenos Aires  
**0810 444 7782**

**Brasil**  
Suporte ao Consumidor  
**0800 701 02 45**  
- São Paulo  
**29 38 02 45**