

Register your product and get support at

www.philips.com/welcome

PFL43x8

PFL31x8

PFL30x8

EN User Manual

PHILIPS

Contents

1	Important	3	6	Troubleshooting	50
	Safety	3		General issues	50
	Care	5		Channel issues	51
	Legal	6		Picture issues	51
	Sustainability	8		Sound issues	52
	Help and support	9		Connection issues	52
2	Use your TV	10		Contact Philips	53
	TV controls	10	7	Specifications	54
	Watch TV	12		Power and reception	54
	View programme guide	15		Display and sound	54
	Watch 3D	16		Display resolutions	54
	Play multimedia files	17		Multimedia	55
3	Use more of your TV	20		Connectivity	58
	Pause TV	20		Help version	58
	Record TV shows	21	8	Index	59
	Play games	24			
	View Text	25			
	Set locks and timers	26			
4	Change your TV settings	28			
	Picture and sound	28			
	Channels	30			
	Satellite settings	32			
	Language settings	33			
	Universal access settings	34			
	Other settings	35			
	Update software	35			
	Reset all	36			
5	Connect your TV	37			
	About cables	37			
	Connect antenna	38			
	Connect devices	38			
	Connect more devices	44			
	Watch connected devices	46			
	Set up EasyLink devices	46			
	Connect a CAM (Conditional Access Module)	49			

1 Important

Safety

Precautions

Read and understand all instructions before you use your TV. If damage is caused by failure to follow the instructions, the warranty does not apply.

Risk of electric shock or fire!

- Never expose the TV to rain or water. Never place liquid containers, such as vases, near the TV. If liquids are spilled on or into the TV, disconnect the TV from the power outlet immediately. Contact Philips Consumer Care to have the TV checked before use.
- Never place the TV, remote control or batteries near naked flames or other heat sources, including direct sunlight. To prevent the spread of fire, keep candles or other flames away from the TV, remote control and batteries at all times.



- Never insert objects into the ventilation slots or other openings on the TV.
- Never expose the remote control or batteries to rain, water or excessive heat.
- Avoid force coming onto power plugs. Ensure that the power plug is fully inserted into the power socket. Loose power plugs can cause arcing or fire.

- When the TV is swivelled, ensure that no strain is exerted on the power cord. Strain on the power cord can loosen connections and cause arcing.
- To disconnect the TV from the mains power, the power plug of the TV must be disconnected. When disconnecting the power, always pull the power plug, never the cord. Ensure that you have full access to the power plug, power cord and outlet socket at all times.

Risk of damage to the TV!

- Two people are required to lift and carry a TV that weighs more than 25kg or 55lbs.
- When stand mounting the TV, use only the supplied stand. Secure the stand to the TV tightly. Place the TV on a flat, level surface that can support the combined weight of the TV and the stand.
- When wall mounting the TV, use only a wall mount that can support the weight of the TV. Secure the wall mount to a wall that can support the combined weight of the TV and wall mount. TP Vision Netherlands B.V. bears no responsibility for improper wall mounting that result in accident, injury or damage.
- If you need to store the TV, disassemble the stand from the TV. Never lay the TV on its back with the stand installed.
- Before you connect the TV to the power outlet, ensure that the power voltage matches the value printed on the back of the TV. Never connect the TV to the power outlet if the voltage is different.
- Parts of this product may be made of glass. Handle with care to avoid injury and damage.

Risk of injury to children!

Follow these precautions to prevent the TV from toppling over and causing injury to children:

- Never place the TV on a surface covered by a cloth or other material that can be pulled away.
- Ensure that no part of the TV hangs over the edge of the surface.
- Never place the TV on tall furniture, such as a bookcase, without anchoring both the furniture and TV to the wall or a suitable support.
- Educate children about the dangers of climbing on furniture to reach the TV.

Risk of swallowing batteries!

- The product/remote control may contain a coin-type battery, which can be swallowed. Keep the battery out of reach of children at all times!

Risk of overheating!

- Never install the TV in a confined space. Always leave a space of at least 4 inches or 10 cm around the TV for ventilation. Ensure that curtains or other objects never cover the ventilation slots on the TV.

Risk of injury, fire or power cord damage!

- Never place the TV or any objects on the power cord.
- Disconnect the TV from the socket and aerial before lightning storms. During lightning storms, never touch any part of the TV, power cord or aerial cable.

Risk of hearing damage!

- Avoid using earphones or headphones at high volumes or for prolonged periods of time.

Low temperatures

- If the TV is transported in temperatures below 5°C or 41°F, unpack the TV and wait until the TV temperature matches room temperature before connecting the TV to the power outlet.

3D health warning

For 3D TVs only.

- If you or your family have a history of epilepsy or photosensitive seizures, consult a medical professional before exposing yourself to flashing light sources, rapid image sequences or 3D viewing.
- To avoid discomfort such as dizziness, headache or disorientation, we recommend not watching 3D for extended periods of time. If you experience any discomfort, stop watching 3D and do not immediately engage in any potentially hazardous activity (for example driving a car) until your symptoms have disappeared. If symptoms persist, do not resume watching 3D without consulting a medical professional first.
- Parents should monitor their children during 3D viewing and ensure they do not experience any discomfort as mentioned above. Watching 3D is not recommended for children under six years of age as their visual system is not fully developed yet.
- Do not use the 3D glasses for any purpose other than watching this 3D TV.
- When viewing 3D content with active 3D glasses under fluorescent or LED lighting, you may notice flickering being emitted from the lights. If flickering occurs, switch off the lights.

Care

Screen

- Risk of damage to the TV screen!
Never touch, push, rub or strike the screen with any object.
- Unplug the TV before cleaning.
- Clean the TV and frame with a soft damp cloth and wipe gently. Never use substances such as alcohol, chemicals or household cleaners on the TV.
- To avoid deformations and colour fading, wipe off water drops as soon as possible.
- Avoid stationary images as much as possible. Stationary images are images that remain onscreen for extended periods of time. Stationary images include onscreen menus, black bars, time displays, etc. If you must use stationary images, reduce screen contrast and brightness to avoid screen damage.

3D glasses

For sets with 3D glasses supplied.

Follow these instructions to take care of your glasses:

- Use a clean soft cloth (microfibre or cotton flannel) to clean the lenses to avoid scratching them. Never spray cleaner directly on the 3D glasses. You can use pre-moistened cleaning cloths from most well-known lens manufacturers of sunglasses.
- Do not expose the 3D glasses to direct sunlight, heat, fire or water. This may result in a product malfunction or fire.
- Do not drop, bend or apply force to the lenses of the 3D glasses.
- Do not use cleaning chemicals containing alcohol, solvent, surfactant, or wax, benzene, thinner, mosquito repellent or lubricant. Using these chemicals can cause discolouration or cracks.

- **CHOKING HAZARD** - Keep the product out of reach of children under three years of age at all times! The product contains small parts which can be swallowed.

Placement tips

- Position the TV where light does not shine directly on the screen.
- The ideal viewing distance of this TV is three times its diagonal screen size. For example, if the diagonal screen size of the TV is 81 cm / 32", the ideal viewing distance is ~2.5 m / ~92" from the front of the screen.
- While seated, your eyes should be level with the centre of the screen.

TV placement

You can apply the best sound settings for your TV by selecting the TV placement (wall mount or stand mount).

1. Press .
2. Select **[Setup]**, then press **OK**.
3. Select **[TV settings] > [General settings]** or **[TV placement]**.
4. Select **[On a TV stand]** or **[Wall mounted]**, then press **OK**.

Lock the TV

Your TV is equipped with a Kensington security slot at the base of the TV. To secure the TV, purchase a Kensington anti-theft lock (sold separately).

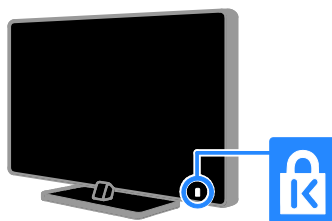

Legal

Notice

2013 © TP Vision Netherlands B.V. All rights reserved. Specifications are subject to change without notice. Trademarks are the property of Koninklijke Philips Electronics N.V or their respective owners. TP Vision Netherlands B.V. reserves the right to change products at any time without being obliged to adjust earlier supplies accordingly.

The material in this manual is believed adequate for the intended use of the system. If the product, or its individual modules or procedures, are used for purposes other than those specified herein, confirmation of their validity and suitability must be obtained. TP Vision Netherlands B.V. warrants that the material itself does not infringe any United States patents. No further warranty is expressed or implied.

TP Vision Netherlands B.V. cannot be held responsible neither for any errors in the content of this document nor for any problems as a result of the content in this document. Errors reported to Philips will be adapted and published on the Philips support website as soon as possible.

Terms of warranty

- Risk of injury, damage to TV or void of warranty! Never attempt to repair the TV yourself.
- Use the TV and accessories only as intended by the manufacturer.
- The caution sign printed on the back of the TV indicates risk of electric shock. Never remove the TV cover. Always contact Philips Customer Care for service or repairs.
- Any operation expressly prohibited in this manual, or any adjustments and assembly procedures not recommended or authorised in this manual, shall void the warranty.

Pixel characteristics

This LCD/LED product has a high number of colour pixels. Although it has effective pixels of 99.999% or more, black dots or bright points of light (red, green or blue) may appear constantly on the screen. This is a structural property of the display (within common industry standards) and is not a malfunction.

CE compliance

This product is in compliance with the essential requirements and other relevant provisions of Directives 2006/95/EC (Low Voltage), 2004/108/EC (EMC) and 2011/65/EU (ROHS).



Compliance with EMF

TP Vision Netherlands B.V. manufactures and sells many products targeted at consumers which, like any electronic apparatus, in general have the ability to emit and receive electromagnetic signals.

One of Philips' leading Business Principles is to take all necessary health and safety measures for our products, to comply with all applicable legal requirements and to stay well within the Electro Magnetic Field (EMF) standards applicable at the time of producing the products.

Philips is committed to develop, produce and market products that cause no adverse health effects. TP Vision confirms that, as long as its products are handled properly for their intended use, they are safe to use according to scientific evidence available today.

Philips plays an active role in the development of international EMF and safety standards, enabling Philips to anticipate further developments in standardisation for early integration in its products.

Open source

This product contains software licensed under an open-source licence. For acknowledgments and licence texts, please refer to the electronic in-product user manual. TP Vision Netherlands B.V. hereby offers to deliver, upon request, a copy of the complete corresponding source code for the copyrighted open source software packages used in this product for which such offer is requested by the respective licences.

This offer is valid up to three years after product purchase to anyone in receipt of this information. To obtain source code, please send your request in English with product number to:

"Intellectual Property Department, TP Vision Netherlands B.V., P.O. Box 80077, 5600 KA Eindhoven, The Netherlands".

Trademarks and copyrights

Windows Media is either a registered trademark or trademark of Microsoft Corporation in the United States and/or other countries.



Manufactured under licence from Dolby Laboratories. Dolby and the double-D symbol are trademarks of Dolby Laboratories.



The terms HDMI and HDMI High-Definition Multimedia Interface and the HDMI Logo are trademarks or registered trademarks of HDMI Licensing LLC in the United States and other countries.



Kensington and Micro Saver are registered US trademarks of ACCO World Corporation with issued registrations and pending applications in other countries throughout the world.



Covered by one or more of the following U.S. patents: 7,295,673; 7,460,668; 7,515,710; 7,519,274.

DivX®, DivX Certified® and associated logos are trademarks of Rovi Corporation or its subsidiaries and are used under licence.

ABOUT DIVX VIDEO: DivX® is a digital video format created by DivX, LLC, a subsidiary of Rovi Corporation. This is an official DivX Certified® device that plays DivX video. Visit divx.com for more information and software tools to convert your files into DivX videos.

ABOUT DIVX VIDEO-ON-DEMAND: This DivX Certified® device must be registered in order to play purchased DivX Video-on-Demand (VOD) movies. To obtain your registration code, locate the DivX VOD section in your device setup menu. Go to vod.divx.com for more information on how to complete your registration.

All other registered and unregistered trademarks are the property of their respective owners.

Sustainability

Energy efficiency

This TV is designed with energy-efficient features. To access these features, press the **Green button** on the remote control.

- **Energy saving picture settings:** You can apply a combination of energy saving picture settings. While you watch TV, press the **Green button** and select **[Energy saving]**. Then select the **[Energy saving]** picture setting.
- **Screen off:** If you only want to listen to audio from the TV, you can switch off the TV display. Other functions continue to operate normally. While you watch TV, press the **Green button** and select **[Screen off]**.
- **Light sensor:** When the surrounding light darkens, the built-in ambient light sensor lowers the brightness of the TV screen. To switch on the sensor, press the **Green button** while you watch TV and select **[Light sensor]**.
- **Low standby power:** The advanced power circuitry reduces the power consumption of the TV to an extremely low level, without losing the constant standby functionality.
- **Auto switch off:** To conserve energy, set the TV to switch off automatically after a period of inactivity. While you watch TV, press the **Green button** and select **[Auto switch off]**. Then select the period after which the TV switches off.
- **Switch off inactive devices:** Switch off connected EasyLink HDMI-CEC (Consumer Electronic Control) compliant devices that are inactive. While you watch TV, press the **Green button** and select **[Inactive devices off]**.

- **Power management:** An advanced power management helps save the energy consumed by this TV. To view how your personalised TV settings affect the TV's relative power consumption, press **🏠**, then select **[Setup] > [Watch demos] > [Active Control demo]**.

Recycling

Your product is designed and manufactured with high quality materials and components, which can be recycled and reused.



When this crossed-out wheeled bin symbol is attached to a product it means that the product is covered by the European Directive 2002/96/EC. Please inform yourself about the local separate collection system for electrical and electronic products.



Please act according to your local rules and do not dispose of your old products with your normal household waste. Correct disposal of your old product helps to prevent potential negative consequences for the environment and human health.

Your product contains batteries covered by the European Directive 2006/66/EC, which cannot be disposed of with normal household waste. Please inform yourself about the local rules on separate collection of batteries because correct disposal helps to prevent negative consequences for the environment and human health.



Energy label

The European Energy Label informs you on the energy efficiency class of the product. The greener the energy efficiency class of this product is, the lower the energy it consumes.

On the label, you can find the energy efficiency class, the average power consumption of the product in use and the average energy consumption for 1 year. You can also find the power consumption values for the product on the Philips website for your country at www.philips.com/TV.

Help and support

Use Help

To access the onscreen **[Help]** menu, press the **Blue button**.

To exit from the **[Help]** menu, press **⏏**.

Visit the Philips website

If you can't find what you need in the onscreen **[Help]**, visit the Philips support website at www.philips.com/support.

On the Philips support website, you can also:

- Find answers to Frequently Asked Questions (FAQ)
- Download a printable PDF version of this user manual
- Email us a specific question
- Chat online with Philips Consumer Care (available in certain countries only)

Use the Philips connectivity guide

An easy-to-use connectivity guide gives you guidance on how to connect your TV to other devices. Visit

<http://www.connectivityguide.philips.com>.

Search the TV forum

Your question may have already been answered by the Philips TV community of users. Visit www.supportforum.philips.com.

Contact Philips

You can contact Philips Consumer Care in your country for support. The number is available in the leaflet accompanying this product or online at www.philips.com/support.

Before you contact Philips, write down the model and serial number of your TV. You can find this information on the back of your TV or on the TV packaging.

2 Use your TV

TV controls

Rear controls

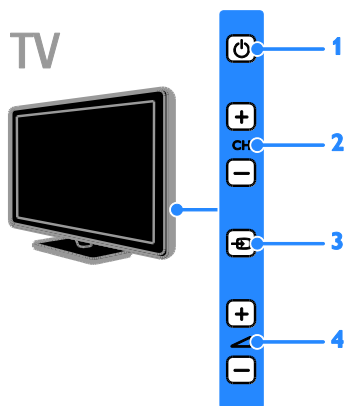

1. **⏻ (Standby):** Switch the TV on or off.
2. **CH +/-:** Switch to the next or previous channel.
3. **📺 (SOURCE):** Watch a connected device.
4. **🔊 +/- (Volume):** Increase or decrease volume.

Sensors and indicators

TV

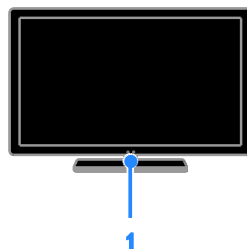

For PFL4xx8

1. Remote control sensor

Point the remote control at the sensor.
Make sure that the line of sight between the remote control and the TV is not blocked.

TV

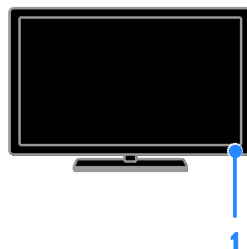

For PFL3xx8

1. Remote control sensor

Point the remote control at the sensor.
Make sure that the line of sight between the remote control and the TV is not blocked.

Remote control

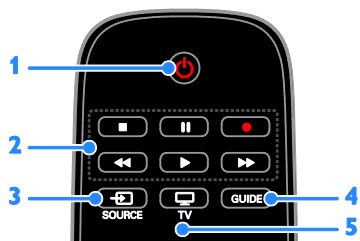

1. **⏻ (Standby):** Switch the TV on or to standby.
2. **Play buttons:** Control playback of multimedia files.
3. **SOURCE:** Watch a connected device.
4. **GUIDE:** View programme guide.
5. **TV:** Watch TV.



6. **🏠 (Home):** Access the Home menu.
7. **OK:** Confirm an entry or selection.
8. **▲▼▶◀ (Navigation buttons):** Navigate through menus and select items.

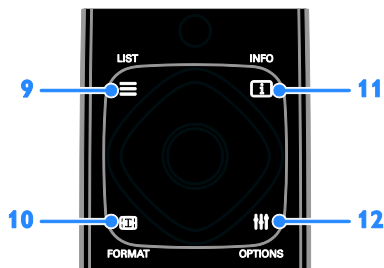

9. **≡ LIST:** Access the TV channel list.
10. **🖼️ FORMAT:** Change the picture format to suit the video source.
11. **📄 INFO:** Display information about the current activity.
12. **⋮ OPTIONS:** Access currently available options, picture and sound menus.

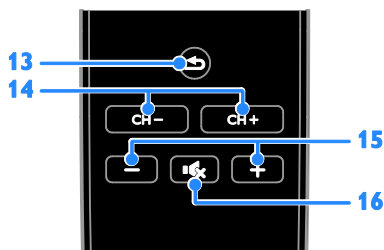

13. **⏪ (Back):** Return to the previous menu page or exit from a TV function.
14. **CH +/-:** Switch channels.
15. **+/- (Volume):** Adjust volume.
16. **🔇 (Mute):** Mute or restore audio.

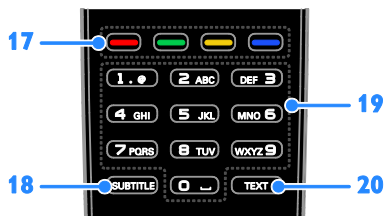

17. **Colour buttons:** Select tasks or options. The buttons function according to the services offered by the service provider.
18. **SUBTITLE:** Switch subtitles on or off.
19. **0-9 (Numeric buttons):** Select TV channels or enter text.
20. **TEXT:** Enable or disable text.

EasyLink controls

If you connect your TV to HDMI-CEC enabled devices, such as a Blu-ray player or home theatre, you can control them at the same time with one remote control. Simply switch on EasyLink after connection.

Read more about Easylink in **Connect your TV > Set up Easylink devices > Control devices** (Page 47).

On-screen remote control

You can also control connected HDMI-CEC enabled devices through other buttons that are available through the on-screen remote control. Make sure that Easylink is switched on after connection. Read more about Easylink in **Connect your TV > Set up Easylink devices > Control devices** (Page 47).

To access the on-screen remote control

1. While you watch a connected device, press **III** **OPTIONS**.
2. Select **[Show remote control]**, then press **OK**.
3. Select an on-screen button, then press **OK**.

Watch TV

Switch TV on or off

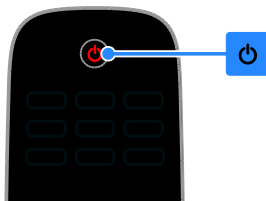

Switch the TV on

- Connect the TV to the mains outlet and switch on the main power.
- If the TV is not switched on, the standby LED remains off. Press **⏻** on the TV.
- If the standby LED is lit, press **⏻** on the remote control.

Note: There is a short delay before the TV responds.

Tip: If you cannot find your remote control and want to switch on the TV from standby, press any button on the TV.

Switch TV to standby

Press **⏻** on the remote control.

The standby LED on the TV switches to red.

Switch off the TV

Press **⏻** on the TV.

The standby LED switches to off.

Note: Though your TV consumes very little energy when it is in standby or switched off, it does use some energy. If you are not going to use the TV for an extended period of time, disconnect the TV from the mains plug.

Automatic switch off

You can save energy with this TV's energy efficiency settings, which are enabled by default. If there is no user interaction (such as pressing a remote control button or a control on the TV) for four hours, the TV will automatically switch to standby.

To disable automatic switch off

1. While you watch TV, press the **Green button** on the remote control.
2. Select **[Auto switch off]**, then press **OK**.
3. Select **[Off]**, then press **OK**.

Adjust TV volume

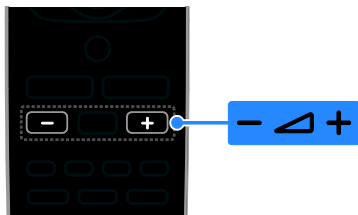

TV



Increase or decrease the TV volume

- Press +/- on the remote control.
- Press +/- on the TV.

Mute or restore the TV volume

- Press on the remote control to mute the volume.
- Press again to restore the volume.

Adjust headphone volume

1. Press .
2. Select **[Setup]** > **[TV settings]** > **[Sound]** > **[Headphone volume]**, then press **OK**.
3. Select a level.

Switch TV channels

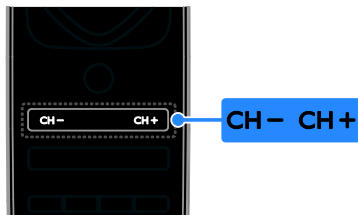

TV



- Press **CH +/-** on the remote control or TV.
- Press the **Numeric buttons** on the remote control to enter a channel number.

Manage favourite channels

You can view all channels or only a list of your favourite channels.

Create a list of your favourite channels

1. Press **LIST**.
The channel list is displayed.
2. Select the channel to mark as favourite, then press **OPTIONS**.
3. Select **[Add/remove favourites]**, then press **OK**.
The selected channel is marked with an asterisk.

To remove a channel from the favourites list, select **[Add/remove favourites]**, then press **OK**.

Display your list of favourite channels

1. Press **LIST**, then press **OPTIONS**.
2. Select **[List]** > **[Favourites]** to display channels in the favourite list.
3. Press **OK** to confirm.

Manage channel lists

After the channels are installed, you can:

- Filter channels.
- Switch between antenna and cable channels.
- Rename channels.
- Reorder channels.
- Lock a channel.
- Listen to digital radio.

Filter channels

1. While you watch TV, press **≡ LIST**.
2. Press **≡ OPTIONS**, then select **[Filter]**.
3. Select an option, then press **OK**.
 - **[Digital + Analogue]**: Display all channels in the channels list.
 - **[Digital TV channels]**: Display only digital channels.
 - **[Analogue Channels]**: Display only analogue channels.
 - **[Free / scrambled]**: Display all channels in the channels list.
 - **[Scrambled channels]**: Display only scrambled channels.
 - **[Free channels]**: Display only free channels.

Note: The filtering options may vary according to your broadcaster.

Switch between antenna and cable channels

You can switch between antenna and cable channels while you are watching TV.

1. While you watch TV, press **🏠**.
2. Select **[Setup] > [Channel settings] > [Channel installation] > [Antenna connection]**.
3. Select **[Antenna (DVB-T)]** to watch antenna channels or **[Cable (DVB-C)]** to watch cable channels, then press **OK**.

Rename channels

When you select a channel, its name appears. You can change this channel name.

1. While you watch TV, press **≡ LIST**. The channel list is displayed.
2. Select the channel to rename, then select **≡ OPTIONS**.

3. Select **[Rename]**, then press **OK**. The onscreen keyboard is displayed.
4. Press the **Navigation buttons** to select each character, then press **OK**.
5. Once complete, select **[Done]**, then press **OK** to confirm.

Reorder channels

After the channels have been installed, you can reorder the channel list.

1. While you watch TV, press **≡ LIST**. The channel list is displayed.
2. Press **≡ OPTIONS**.
3. Select **[Reorder]**, then press **OK**.
4. Select the channel to reorder, then press **OK**.
5. Press the **Navigation buttons** to move the highlighted channel to another location, then press **OK**.
6. Once complete, press **≡ OPTIONS**.
7. Select **[Exit reorder]**, then press **OK**.

Lock a channel

You can prevent unauthorised access to channels by locking them.

1. While you watch TV, press **≡ LIST**. The channel list is displayed.
2. Select the channel to lock, then press **≡ OPTIONS**.
3. Select **[Lock channel]**, then press **OK**.
4. If prompted, enter the PIN code. The channel is marked with a lock icon in the channel list.

Tip: To watch a locked channel, enter the PIN code when prompted.

Listen to digital radio

If digital radio channels are available, you can listen to them. They are installed automatically when you install the TV channels.

1. While you watch TV, press **≡ LIST**. The channel list is displayed.
2. Press **≡ OPTIONS**.
3. Select **[Filter] > [Radio]**, then press **OK**.
4. Select a radio channel, then press **OK**.

Watch connected devices

Before you can watch a device, connect the device to the TV. See **Connect your TV > Connect devices** (Page 38).

Select a device with SOURCE

1. Press **SOURCE**.
2. Select a device, then press **OK**.

Select a device from the Home menu

1. Press **Home**.
2. Select **[Source]**, then press **OK**.
3. Select the device, then press **OK**.

To add or manage your connected devices, see **Connect your TV > Watch connected devices > Change device settings** (Page 46).

Use picture and sound presets

Your TV comes with predefined picture and sound settings. You can apply these settings or customise them.

Select your preferred picture settings

1. While you watch TV, press **Options**.
2. Select **[Picture and sound] > [Picture style]**, then press **OK**.
3. Select an option, then press **OK**:
 - **[Personal]**: Apply your personalised picture settings.
 - **[Vivid]**: Rich and dynamic settings, ideal for daytime viewing.
 - **[Natural]**: Natural picture settings.
 - **[Standard]**: Default settings that suit most environments and types of video.
 - **[Movie]**: Ideal settings for movies.
 - **[Photo]**: Ideal settings for photos.
 - **[Energy saving]**: Settings that conserve the most energy.

Select your preferred sound settings

1. While you watch TV, press **Options**.
2. Select **[Picture and sound] > [Sound style]**, then press **OK**.
3. Select an option, then press **OK**:
 - **[Personal]**: Apply your personalised sound settings.
 - **[Original]**: Settings that suit most environments and types of audio.
 - **[Movie]**: Ideal settings for movies.
 - **[Music]**: Ideal settings for listening to music.

- **[Game]**: Ideal settings for games.
- **[News]**: Ideal settings for spoken audio, such as the news.

Change picture format

You can change the picture format to suit the video source.

1. Press **Format**.
2. Select a picture format, then press **OK**.

The available picture formats depend on the video source:

- **[Auto fill]**: Adjust the picture to fill the screen (subtitles remain visible). Recommended for minimal screen distortion but not for HD or PC.
- **[Auto zoom]**: Enlarge the picture to fill the screen. Recommended for minimal screen distortion but not for HD or PC.
- **[Super zoom]**: Remove the black bars on the sides of 4:3 broadcasts. Not recommended for HD or PC.
- **[Movie expand 16:9]**: Scale 4:3 format to 16:9. Not recommended for HD or PC.
- **[Wide screen]**: Shows widescreen format content unstretched. Not recommended for HD or PC.
- **[Unscaled]**: Provide maximum detail for PC. Only available when PC mode is selected in the Picture menu.
- **[4:3]**: Display the classic 4:3 format.

View programme guide

What you can do

You can view channel schedules and programme synopses for digital TV channels using programme guides provided by the broadcasters. The availability of programme guides is dependent on your broadcaster.

You cannot view a channel's programme guide information if:

- the age rating of the channel is equal or higher than the age rating set on your TV.
- the channel is locked.

From the broadcaster

Select broadcaster programme guide

Before you use the programme guide, check the following settings:

1. Press **Home**.
2. Select **[Setup] > [TV settings] > [General settings] > [TV guide]**.
3. Select **[From the broadcaster]**, then press **OK**.

Access broadcaster programme guide

1. Press **Home**.
2. Select **[TV guide]**, then press **OK**.
3. If you are viewing the programme guide for the first time, follow the onscreen instructions to update the guide.

Customise broadcaster programme guide

You can customise the displayed information to:

- Remind you when programmes start.
- Display only preferred channels.
- Change day of display.
- Schedule recordings of programmes. See **Use more of your TV > Record TV shows > Schedule recordings** (Page 22).

Note: Options may vary according to the programme information available from the broadcaster.

1. In the programme guide, press **Options**.
2. Select an option, then press **OK**:
 - **[Update TV guide]:** Update programme guide information.
 - **[Change day]:** Select the day to display programme guide.
 - **[Search by genre]:** Search programmes by genre.
 - **[All reminders]:** Display a list of all programme reminders.

Watch 3D

What you need

For PFL43x8 only.

Your TV is a 3D TV. Before you watch 3D, read the health warning information in **Important > 3D health warning** (Page 4). To watch 3D on this TV, you need the Philips Active 3D glasses PTA508 or PTA518 (sold separately).

Note:

- 3D glasses from other brands may reduce or lose the 3D effect.
- Some 3D formats are not supported.
- When viewing 3D content under fluorescent or LED lighting, you may notice flickering being emitted from the lights. If flickering occurs, switch off the lights.

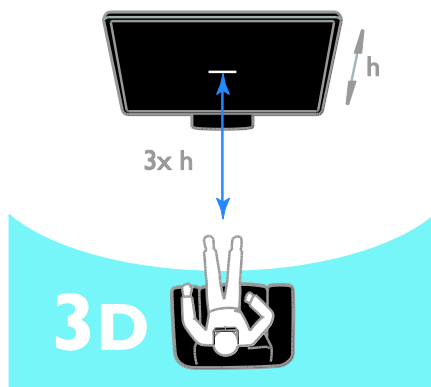

To experience the best 3D effect while you watch 3D programmes:

- Sit at a distance that is at least three times the height (h) of the TV screen away from the TV. Do not sit more than 6 m away.

Start 3D

Automatically enable 3D

The TV detects when 3D is available and prompts you to put on your 3D glasses to start watching. To set the TV response when a 3D signal is detected:

1. Press **HOME**.
2. Select **[Setup]** > **[TV settings]** > **[3D]** > **[Switch to 3D]**.
3. Select a setting, then press **OK**.
 - **[Automatic]:** TV switches to 3D automatically.
 - **[Notification only]:** TV displays notification first.
 - **[Never]:** No notification.

Select a source with 3D

For 3D discs:

1. Play the disc on a 3D Blu-ray disc player that is connected to the TV HDMI connector.
2. Press **[SOURCE]**, then select the 3D Blu-ray disc player.

For 3D TV programmes:

1. Select **[Watch TV]**, then switch to a TV channel that broadcasts 3D content.

Note:

- To switch back to 2D, press **[[[OPTIONS]**. Select **[Picture and sound]** > **[3D settings]** > **[2D]**.
- If you switch to another channel or a connected device, the TV switches to 2D.

Select 3D input format

The TV detects when 3D is available and prompts you to put on your 3D glasses to start watching. If the TV cannot detect the 3D signal due to a missing 3D signal tag, it displays images that overlap.

To switch the overlapping images to 3D, change the 3D format.

1. Press **[[[OPTIONS]**.
2. Select **[Picture and sound]** > **[3D settings]**.
3. Select a setting, then press **OK**.
 - **[3D - Side by side]:** Select if the TV displays pictures that overlap vertically.

- **[3D - Top / bottom]:** Select if the TV displays pictures that overlap horizontally.
- **[3D - top/bottom inverted]** or **[3D - side by side inverted]:** Select if the TV displays distorted images, such as the background appearing nearer to you.

Convert 2D to 3D

You can convert any 2D programme to watch it in 3D.

1. Press **[[[OPTIONS]**.
2. Select **[Picture and sound]** > **[3D settings]** > **[2D to 3D conversion]**.

To adjust the 3D depth:

1. Press **[[[OPTIONS]**.
2. Select **[Picture and sound]** > **[3D effect]**.
3. Select an option, then press **OK**.

To switch off 2D to 3D conversion:

1. Press **[[[OPTIONS]**.
2. Select **[Picture and sound]** > **[3D settings]** > **[2D]**, then press **OK**.

Note: If you switch to another activity, the conversion stops.

Play multimedia files

What you can do

You can play videos, photos and music on your TV from a USB device connected to the TV.

Play files from USB device

If you have photos, videos or music files on a USB storage device, you can play the files on TV.

Caution:

- TP Vision is not responsible if the USB hard drive is not supported, nor is it responsible for damage to or loss of data in the device.
- Do not overload the USB port. If you connect a USB storage device that consumes more than 500mA power, make sure that it is connected to its own external power supply.

Browse USB device

1. Connect the USB device to the USB connector on the TV.
2. Press **▢ SOURCE**, select **[USB]**, then press **OK**.
3. Select a file from the content browser, then press **OK** to start play.
4. Press the **Play buttons** to control play.
5. Optional: To select a different USB device, select **[USB device]** at the bottom of the TV screen.

Tips:

- Select the top bar to filter your files by type.
- Select **[Sort]** to arrange the files by name, date or other fields.

Play options

Watch video

1. Select **▢** in the top bar.
2. Select a video, then press **OK**.
3. Optional: To play all the videos in a folder, select a video, then select **[Play all]**.
 - To skip to the next or previous video, press **CH+** or **CH-**.
 - To pause the video, press **OK**. Press **OK** again to resume playback.
 - To skip forward or backward 10 seconds, press **▶** or **◀**.
 - To search forward or backwards, press **▶▶** or **◀◀**. Press the button repeatedly to toggle between different speeds.
 - To stop the video, press **■**.

Video options

While you play video, press **≡ OPTIONS**, then press **OK** to select an option:

- **[Subtitles]**: Select the available subtitle settings.
- **[Subtitle language]**: Select the language for subtitles if available.
- **[Character set]**: Select the correct character set for the subtitles.
- **[Audio language]**: Select an audio language.
- **[Repeat]**: Select **[Repeat]** to play the video file repeatedly or **[Play once]** to play the video file once.

- **[Media server]**: When you play content from a media server, you can select another media server.
- **[Shuffle on] / [Shuffle off]**: Enable or disable random play of video files.
- **[DivX® VOD]**: Display the DivX registration and deregistration codes for this TV.

Note:

To view information about a video (for example, played position, duration, title or date), select the video, then press **▢ INFO**. To hide the information, press **▢ INFO** again.

Listen to music

1. Select **🎵** in the top bar.
2. Select a track, then press **OK**.
3. Optional: To play all the tracks in a folder, select a track, then select **[Play all]**.
 - To skip to the next or previous track, press **CH+** or **CH-**.
 - To pause the track, press **OK**. Press **OK** again to resume playback.
 - To skip forward or backward 10 seconds, press **▶** or **◀**.
 - To search forward or backwards, press **▶▶** or **◀◀**. Press repeatedly to toggle between different speeds.
 - To stop the music, press **■**.

Music options

While you play music, press **≡ OPTIONS**, then press **OK** to select an option:

- **[Repeat]**: Select **[Repeat]** to play a track or an album repeatedly, or select **[Play once]** to play a track once.
- **[Media server]**: When you play content from a media server, you can select another media server.
- **[Shuffle on] / [Shuffle off]**: Enable or disable random play of tracks.

Note:

To view information about a song (for example, title, artist or duration), select the song, then press **▢ INFO**.

To hide the information, press **▢ INFO** again.

View photos

1. Select  in the top bar.
2. Select a photo thumbnail, then press **OK**.

Start a slideshow

If there are multiple photos in a folder, select a photo, then select **[Slideshow]**.

- To skip to the next or previous video, press **CH+** or **CH-**.
- To stop the slideshow or close the photo, press **≡ LIST** or **■**.

Slideshow options

While you play a slideshow, press **≡ OPTIONS**, then press **OK** to select an option:

- **[Shuffle off] / [Shuffle on]**: Enable or disable random display of pictures in the slideshow.
- **[Repeat]**: Select **[Repeat]** to watch a slideshow repeatedly or **[Play once]** to watch once.
- **[Slideshow time]**: Select the display time for each photo in the slideshow.
- **[Slideshow transitions]**: Select the transition from one photo to the next.
- **[Media server]**: When you play content from a media server, you can select another media server.

Play DivX® VOD (Video On Demand)

This TV is DivX Certified(R) and plays high-quality DivX Video-On-Demand videos.

To play DivX VOD videos from your computer, you must first activate DivX VOD on the TV. The DivX VOD activation of your TV is free of charge.

Register the TV

If the TV is not yet activated when you start the playback of a rental DivX video, the TV displays the DivX registration code to activate this TV.

To register, follow these steps.

1. When the TV displays the 8 or 10-digit registration code, write down the code and go to <http://vod.divx.com>.
2. Download the DivX player software on your computer and install the software.
3. Start the DivX player software and create a DivX Account: Click VOD > Create a DivX Account.
4. In the DivX player, register the TV with the registration code of the TV: Click VOD > Register a DivX Certified Device.
5. When prompted, download and save the registration video to a USB flash drive or your connected media server.
6. Go to your TV and play the registration video on your TV. This completes the registration and activates DivX on your TV. Consult the DivX website for detailed support.

To de-register this TV:

1. Press **⇩ SOURCE**.
2. Select **[Browse USB]**, then press **OK**.
3. Press **≡ OPTIONS**, select **[DivX® VOD]**, then press **OK**.
4. Follow the onscreen instructions.

3 Use more of your TV

Pause TV

What you can do

While you watch a digital channel, you can pause a programme to answer a phone call or to have a break. The broadcast is stored on a USB hard drive that is connected to the TV. You can resume playback of the programme at any time.

Note:

- You can pause a programme for a maximum of 90 minutes.

What you need

- Tune your TV to receive digital channels. See **Change your TV settings > Channels > Automatic installation** (Page 30).
- Connect a USB 2.0 compatible hard drive with a minimum capacity of 4 GB and a minimum transfer speed of 30 megabits per second. For optimal performance, use a hard drive with 32 GB of disk space.

Install USB hard drive

To pause TV, you must connect a USB hard drive to the TV and format it.

If the TV does not recognise the USB hard drive, use a PC to format it to NTFS or FAT32 system, then try again.

Caution:

- TP Vision is not responsible if the USB hard drive is not supported, nor is it responsible for damage to or loss of data in the device.
- Formatting removes all data from the connected USB hard drive.

- The USB hard drive is formatted exclusively for this TV. Keep it permanently connected to the TV. You cannot access the contents of the USB hard drive from another TV or PC.
- Do not overload the USB port. If you connect a USB hard drive device that consumes more than 500mA power, make sure that it is connected to its own external power supply.

Note:

- Make sure that the TV and the USB hard drive are switched off.
- While you are formatting the USB hard drive, do not connect other USB devices to the TV.

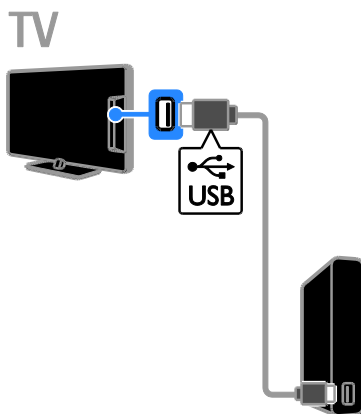

1. Connect the USB hard drive directly to the TV, or if you intend to connect other USB devices in future, connect the USB hard drive through a USB hub.
2. Switch on the TV and the USB hard drive, if it has an external power source.
3. Switch to a digital TV channel.
4. Press **III** to start formatting the USB hard drive.
5. Follow the onscreen instructions to complete the formatting process.

Warning: The formatting process may take some time. Do not switch off the TV or disconnect the USB hard drive until this process is complete.

Pause a live TV broadcast

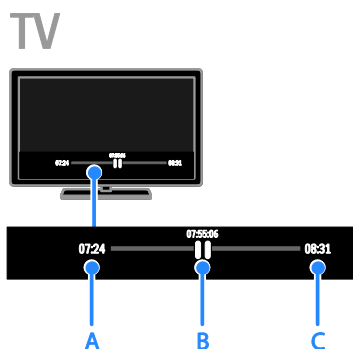

1. On a digital channel, press **II** to pause a TV programme.
2. Press **▶** to continue watching.

The status bar shows the following time indicators:

- A.** When the programme was paused for the first time.
B. Where the paused programme is currently playing.
C. Where the live programme is currently broadcast.

- To watch the stored broadcast, press **◀◀** or **▶▶** to search backward or forward.
- To change playback speed, press **◀◀** or **▶▶** repeatedly.
- To watch the live TV broadcast, press **■**.

Note: If a recording is in progress, you cannot pause the TV broadcast.

The stored broadcast on the USB hard drive is deleted if you:

- Disconnect the USB hard drive.
- Switch the TV to standby.
- Start recording a TV programme.
- Switch to another channel.
- Switch source to watch from a connected device - a Blu-ray disc player or digital receiver.

Record TV shows

What you can do

If your TV can receive programme guides, you can record TV programmes onto a USB hard drive. You can record both current TV programmes as well as future TV programmes.

Note:

- Recording is only supported in countries with programme guides.
- In Nordic countries, the TV provides limited support for subtitles while recording TV programmes.

What you need

- Tune your TV to receive digital TV channels such as DVB broadcasts. See **Change your TV settings > Channels > Automatic installation** (Page 30).
- Connect a USB 2.0 compatible hard drive with a minimum capacity of 32 GB and a minimum transfer speed of 30 megabits per second. For optimal performance, use a hard drive with 250 GB of disk space. You can use the same USB hard drive to record and pause TV shows.

Install USB hard drive

To record TV shows, you must connect a USB hard drive to the TV and format it.

If the TV does not recognise the USB hard drive, use a PC to format it to NTFS or FAT32 system, then try again.

Caution:

- TP Vision is not responsible if the USB hard drive is not supported, nor is it responsible for damage to or loss of data in the device.
- Formatting removes all data from the connected USB hard drive.
- The USB hard drive is formatted exclusively for this TV. Keep it permanently connected to the TV. You cannot access the contents of the USB hard drive from another TV or PC.

- Do not overload the USB port. If you connect a USB hard drive device that consumes more than 500mA power, make sure that it is connected to its own external power supply.

Note:

- Make sure that the TV and the USB hard drive are switched off.
- While you are formatting the USB hard drive, do not connect other USB devices to the TV.

TV

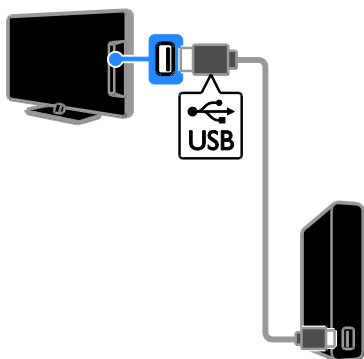

1. Connect the USB hard drive directly to the TV, or if you intend to connect other USB devices in future, connect the USB hard drive through a USB hub.
2. Switch on the TV and the USB hard drive, if it has an external power source.
3. Switch to a digital TV channel.
4. Press **II** to start formatting the USB hard drive.
5. Follow the onscreen instructions to complete the formatting process.

Warning: The formatting process may take some time. Do not switch off the TV or disconnect the USB hard drive until this process is complete.

Start recording



One-touch recording

You can record the programme you are currently watching with a single button.

1. While you watch TV, press **●**. Recording starts immediately. A pop-up window is displayed, indicating the end time of the programme.
2. Optional: Use the **Navigation buttons** to mark the end time of the recording.
3. Select **[Confirm]**, then press **OK**.
4. To stop recording, press **■**.

Note:

- While recording, you cannot switch TV channels or pause a TV broadcast.
- If TV guide information is not available, a default time of 30 minutes is set for recording. You can change this if needed.

Schedule recordings

View programme information

Depending on the status of a programme, you can start watching it or schedule to record the programme.

1. Press **🏠**.
2. Select **[TV guide]**.
3. Select a channel and programme, then press **OK**.

The programme information is displayed.

Note: If you schedule recordings while you are away, make sure that you leave the TV in standby and keep the USB hard drive switched on.

Schedule a TV programme recording

You can schedule a recording of an upcoming programme that will be broadcast today or in up to eight days' time. You can also schedule a timed recording that is not linked to any programme, if programme guide information is not available.

1. Press **🏠**, then select **[TV guide]**.
2. Select the channel and programme to record.
3. Optional: To record a programme that will be broadcast on another day: press **≡** **OPTIONS**, select **[Change day]**, then select another day.
4. Select **[Record]**.

A pop-up window is displayed.

5. Select and change the recording details with the **Numeric buttons** and **Navigation buttons**.

6. Select **[Confirm]**, then press **OK**.

Change a scheduled recording

1. Press **🏠**.
2. Select **[Recordings]**, then press **OK**.
A list of scheduled recordings is displayed.
3. Select the recording, then select **[Adjust time]**.
4. Change the recording time as needed, then select **[Confirm]**.

Cancel a scheduled recording

1. Press **🏠**.
2. Select **[Recordings]**, then press **OK**.
A list of recordings is displayed.
3. Select the recording, then select **[Remove]**.

Cancel a scheduled recording

1. Press **🏠**.
2. Select **[Recordings]**, then press **OK**.
A list of recordings is displayed.
3. Select the recording, then select **[Remove]**.

The schedule recording is cancelled.

Watch recordings

1. Press **🏠**.
2. Select **[Recordings]**, then press **OK**.
A list of recordings is displayed.
3. Select a recording from the list, then press **OK**.
The recording starts to play.

Sort recordings

1. Press **🏠**.
2. Select **[Recordings]**, then press **OK**.
A list of recordings is displayed.
3. Press **≡** **OPTIONS**.
4. Select an option to sort by name, date, expiry date or type, then press **OK**.

Note:

- If a broadcaster limits the number of days that a recording can be viewed after the programme has been broadcast, the list of recordings shows the number of days before the recording expires.
- If a recording has expired or if a broadcaster restricts playback, the recording cannot be played.
- If a scheduled recording is prevented by the broadcaster or if the recording does not occur as per schedule, it is marked as **[Failed]** in the recordings list.

Delete recordings

You can view a list of all recordings and the remaining USB hard disk space. To free up disk space, delete recordings.

1. Press **🏠**.
2. Select **[Recordings]**, then press **OK**.
A list of recordings is displayed.
3. Select the recording, then select **[Remove]**.

Play games

What you can do

On this TV, you can play regular or two-player* games, in full-screen with optimised picture settings for games.

*For PFL43x8 only

What you need



- Connect your game console to this TV. See **Connect your TV > Connect devices > Game console** (Page 41). A two-player kit (PTA508 or PTA518, sold separately) for two-player, full-screen gaming*. The kit comes with two pairs of gaming glasses. See the user manual of the glasses for information on how to charge them and switch them on.

*For PFL43x8

Start gaming

1. Press **SOURCE**.
2. Select the game console, then press **OK**.
3. If needed, load a game disc on the game console, then select a game to play.
4. Follow the onscreen instructions to start gaming.

Start two-player full-screen gaming

For PFL43x8

Some games offer multi-player and split-screen gaming. The 3D technology of this TV can display the split-screens as two full screen views. With the two-player gaming glasses, each player can experience different views on the same TV.

1. Press **SOURCE**.
2. Select the game console, then press **OK**.
3. If needed, load a game disc on the game console.
4. On the game console, select a multi-player or two-player game, then select split-screen viewing.
5. Press **OPTIONS** on the TV remote control.
6. Select **[Picture and sound] > [Two-player gaming]**.
7. Select **[Top / bottom]** or **[Side by side]**, then press **OK**.
8. Switch on the two-player glasses, press the player selection switch, and then put them on. (See the user manual for the two-player gaming glasses).

Tips: To view game menus or scores, press **OK** to switch viewing mode.

Game settings

Picture setting for games

You can optimise the TV display for gaming without picture lag.

1. Press **HOME**.
2. Select **[Setup] > [TV settings] > [Picture]**, then press **OK**.
3. Select **[Game or computer] > [Game]**.

Sound preset for games

You can optimise sound effects for gaming.

1. Press **OPTIONS**.
2. Select **[Picture and sound] > [Sound style] > [Game]**, then press **OK**.

The TV is ready for gaming.

Note: When your gaming session ends, switch back to your usual sound setting.

View Text

Select a page

While you watch channels that broadcast text, you can view the text.

1. Select a channel that broadcasts text, then press **TEXT**.
2. Select a page in one of the following ways:
 - Enter the page number with the **Numeric buttons**.
 - Press **CH + / CH -** to view the next or previous page.
 - Press the **Colour buttons** to select a colour coded item.

Text options

1. While you view text, press **III OPTIONS**.
2. Select an option:
 - **[Freeze page] / [Unfreeze page]:** Freeze or unfreeze the current page.
 - **[Dual screen] / [Full screen]:** Enable or disable dual screen text. Dual screen displays both the current channel and the text broadcast on two halves of the TV screen.
 - **[T.O.P. overview]:** Table Of Pages (T.O.P.) text broadcasts allow you to jump from one subject to another without entering page numbers.
 - **[Enlarge] / [Normal view]:** Zoom in on the page. Press the **Navigation buttons** to move around the enlarged view.
 - **[Reveal]:** Hide or reveal hidden information on a page, such as solutions to riddles or puzzles.
 - **[Cycle subpages]:** If subpages are available, each is shown automatically.
 - **[Language]:** Switch to a different language group to correctly display different character sets.
 - **[Text 2.5]:** View text with more colours and better graphics than normal text. If Text 2.5 is broadcast by a channel, it is switched on by default.

Text language

For digital TV channels where the broadcasters provide different text languages, you can select your preferred primary and secondary languages.

1. Press **HOME**.
2. Select **[Setup] > [Channel settings]** or **[Satellite settings]**.
3. Select **[Languages] > [Primary Text]** or **[Secondary Text]**.
4. Select a language, then press **OK**.

Subpages

If the text page contains several subpages, you can view each subpage in succession. These subpages are shown on a bar next to the main page number.

Press **◀** or **▶** to select them.

Search

You can search for a word or number that exists on the current text page.

1. While you are viewing text, press **OK** to highlight the first word or number.
2. Press the **Navigation buttons** to skip to the word or number to search.
3. Press **OK** to begin the search.
4. To exit the search, press **▲** until no word or number is highlighted.

Digital text

If a digital TV channel's broadcaster offers dedicated digital text or interactive services, you can view digital text. Channels such as BBC1 may have digital text with more interactive features.

Note: Digital text services are blocked when subtitles are broadcast and switched on. See **Change your TV settings > Language settings > Subtitles on digital channels** (Page 34).

When in digital text:

- Press the **Navigation buttons** to select or highlight items.
- Press the **Colour buttons** to select an option, then press **OK** to confirm or activate.

Set locks and timers

Clock

You can display a clock on the TV. The clock displays the time that is broadcast by your TV service operator.

Display the TV clock

1. While you watch TV, press **III** **OPTIONS**.
2. Select **[Clock]**, then press **OK**.

The clock is displayed on the top right-hand corner of the TV screen.

Change the clock mode

You can change the clock mode to automatic or manual. By default, it is set to automatic mode, which automatically synchronises it to Coordinated Universal Time (UTC). If your TV cannot receive UTC transmissions, change the clock mode to **[Manual]**.

1. While you watch TV, press **▲**.
2. Select **[Setup]** > **[TV settings]** > **[General settings]**.
3. Select **[Clock]** > **[Auto clock mode]**.
4. Select **[Automatic]**, **[Manual]** or **[Country dependent]**, then press **OK**.

Change the time zone

In countries with clock transmission data, you can change the time zone if **[Auto clock mode]** > **[Automatic]** or **[Country dependent]** is selected.

1. In the **[Clock]** menu, select **[Time zone]**.
2. Select your time zone, then press **OK**.

Set daylight saving time

In countries with clock transmission data, you can enable or disable daylight saving time if **[Auto clock mode]** > **[Automatic]** or **[Country dependent]** is selected.

1. In the **[Clock]** menu, select **[Daylight saving]**.
2. Select **[Standard time]** or **[Daylight saving time]**, then press **OK**.

Set the clock manually

You can set the date and time manually. Before you start, set the clock mode to **[Manual]**.

1. In the **[Clock]** menu, select **[Date]** or **[Time]**, then press **OK**.
2. Set the time or date with the **Navigation buttons**.
3. Select **[Done]**, then press **OK**.

Sleep timer

You can switch the TV to standby after a specified time. During the countdown to the specified time, you can switch off your TV earlier or reset the sleep timer.

1. Press **▲**.
2. Select **[Setup]** > **[TV settings]** > **[General settings]** > **[Sleep timer]**.
3. Select the sleep timer duration. The sleep timer can be set up for to 180 minutes. To switch off the sleep timer, set it to zero minutes.
4. Press **OK** to activate the sleeptimer. After the specified time, the TV switches to standby.

Child lock

To protect children from unsuitable TV programmes, you can lock the TV or block age rated programmes.

Set or change the child lock code

1. Press **▲**.
2. Select **[Setup]** > **[Channel settings]** or **[Satellite settings]** > **[Child lock]**.
3. Select **[Set code]** or **[Change code]**.
4. Enter the code with the **Numeric buttons**.

Tip: If you access the channels from the channel list, you are prompted to enter your lock code. If you forget your code, enter '8888' to override any existing codes.

Lock or unlock channels

1. In the child lock menu, select **[Channel lock]**.
2. Enter the child lock code with the **Numeric buttons**.
3. Select the channels to lock or unlock.
Restart the TV to activate the lock.

Note:

If you access the channels from the channel list, you are prompted to enter your lock code.

Parental rating

You can set your TV to display only programmes with age ratings lower than your child's age. This restriction only applies to digital channels from broadcasters that rate their programmes according to age.

1. Press **⏠**.
2. Select **[Setup]** > **[Channel settings]** or **[Satellite settings]**.
3. Select **[Child lock]** > **[Parental rating]**.

You are prompted to enter the child lock code.

4. Enter the child lock code with the **Numeric buttons**.

5. Select an age rating, then press **OK**.

All programmes above the selected age rating are blocked.

For information on child lock codes, see **Use more of your TV > Set locks and timers > Child lock** (Page 26).

4 Change your TV settings

Picture and sound

Settings assistant

You can select picture and sound settings with the help of the settings assistant, which demonstrates the effect of your chosen setting immediately.

1. While you watch TV, press **⌂**.
2. Select **[Setup]** > **[Quick picture and sound settings]**, then press **OK**.
3. Select **[Continue]**, then press **OK**.
4. Follow the onscreen instructions to choose your preferred settings.

More picture settings

You can change the settings in the Picture menu.

1. Press **⌂**.
2. Select **[Setup]** > **[TV settings]** > **[Picture]**, then press **OK**.
3. Select a setting to change, then press **OK**.
 - **[Picture style]**: Select a predefined picture setting.
 - **[Restore style]**: Restore the last-selected predefined picture setting.
 - **[3D backlight contrast]** / **[Backlight contrast]**: Adjust the brightness of the display backlight.
 - **[Colour]**: Adjust the colour saturation of the picture.
 - **[Sharpness]**: Adjust the sharpness of the picture.
 - **[Noise reduction]**: Select the amount of noise reduction for the picture.
 - **[MPEG artifact reduction]**: Smoothen transitions and haziness in the digital picture.
 - **[Pixel Plus]** / **[Digital Crystal Clear]**: Fine-tune each pixel to match surrounding pixels and produce a brilliant, high-definition image.
- **[Advanced sharpness]**: Enable superior sharpness, especially on lines and contours in the picture.
- **[Dynamic contrast]**: Dynamically enhance the details in the dark, medium and light areas of the picture.
- **[Dynamic backlight]**: Select a backlight level to optimise dynamic power consumption and picture contrast.
- **[Colour enhancement]**: Dynamically enhance the vividness and details of colours.
- **[Advanced]**: Access advanced settings such as gamma, tint settings and video contrast settings.
 - **[Light sensor]**: Adjust the brightness of the TV screen automatically according to the lighting conditions of the room.
 - **[Gamma]**: Adjust the non-linear setting for picture luminance and contrast.
 - **[Tint]**: Change the colour balance.
 - **[Custom tint]**: Customise colour balance setting. Only available if **[Tint]** > **[Custom]** is selected.
 - **[3D video contrast]** / **[Video contrast]**: Adjust video contrast.
 - **[Brightness]**: Adjust screen brightness.
 - **[Hue]**: Compensate colour variations in NTSC transmissions.
- **[Game or computer]**: When viewing content from a connected game console, select **[Game]** to apply game settings. When a computer is connected through HDMI, select **[Computer]**. Make sure that **[Format and edges]** > **[Picture format]** > **[Unscaled]** is selected to view maximum detail.
- **[Format and edges]**: Access advanced settings to control the display format of the picture.
 - **[Picture format]**: Change the picture format.
 - **[Screen edges]**: Change the picture size.
 - **[Picture shift]**: If available, move the position of the picture.

More sound settings

You can change the settings in the Sound menu.

1. Press .
2. Select **[Setup]** > **[TV settings]** > **[Sound]**, then press **OK**.
3. Select a setting to change, then press **OK**.
 - **[Sound style]**: Access predefined sound settings.
 - **[Restore style]**: Restore the last selected predefined sound setting.
 - **[Bass]**: Adjust the bass level of the speaker and headphones.
 - **[Treble]**: Adjust the treble level of the speaker and headphones.
 - **[Surround mode]**: Select a surround sound mode to enhance your audio experience.
 - **[Auto incredible surround 3D]**: Select a surround sound mode to enhance your audio experience in 3D mode. For certain models.
 - **[Headphone volume]**: Adjust headphone volume.
 - **[Advanced]**: Access advanced settings to enhance your audio experience.
 - **[Auto volume levelling]**: Enable the reduction of sudden volume changes, for example, when switching channels.
 - **[TV speakers]**: Select the preferred speakers to stream audio from the TV. See **Connect your TV > Set up EasyLink devices > Select speaker output** (Page 48).
 - **[Clear Sound]**: (For certain models only) Enhance sound quality.
 - **[Audio Out format]**: Select the type of audio output through the digital audio output connector. Choose between **[Multichannel]** and **[Stereo]**.
 - **[Audio Out levelling]**: Set the output level for stereo audio. Select **[Less]** for a certain amount of loss in intensity or signal strength. Select **[More]** for no loss in intensity or signal strength.

- **[HDMI 1 - ARC]**: Enable audio output from the ARC-compliant device connected to the HDMI 1 connector.
- **[Audio out delay]**: Automatically sync the image on the TV to the audio from a connected home theatre. You do not need to use this setting when connecting the TV to a Philips home theatre.
- **[Audio out offset]**: Adjust the setting for audio output delay. Available if **[Audio out delay]** is switched on.

Audio format

Digital channels

If a digital TV channel broadcaster streams audio in multiple formats, you can select an audio format.

1. Press .
2. Select **[Setup]** > **[Channel settings]** or **[Satellite settings]** > **[Languages]** > **[Preferred audio format]**.
3. Select an option, then press **OK**.
 - **[Standard]**: Receive standard audio format (MPEG).
 - **[Advanced]**: Receive advanced audio formats, if available (AAC, Dolby Digital or Dolby Digital Plus).

Reset picture and sound

You can restore the default picture and sound settings, while the channel installation settings remain the same.

1. While you watch TV, press .
2. Select **[Setup]** > **[TV settings]** > **[General settings]** > **[Factory settings]**, then press **OK**.
3. Select **[Reset]**, then press **OK**.

All TV settings (except for channel settings) are reset to the default factory settings.

Channels

Automatic installation

When the TV was switched on for the first time, a full installation of channels was performed.

To change your language, country, and reinstall all available TV channels, you can run this full installation again.

Start installation

Note: If you are prompted to enter a code, enter '8888'.

1. Press **⏏**.
2. Select **[Setup]** > **[Search for channels]** > **[Reinstall channels]**, then press **OK**.
3. Select your country, then press **OK**.
4. Select your network, then press **OK**:
 - **[Antenna (DVB-T)]**: Access free-to-air antenna transmissions.
 - **[Cable (DVB-C)]**: Access cable transmissions.
5. Follow the onscreen instructions to select other options, if any.
The start menu for channel search is displayed.
6. Select **[Start]**, then press **OK**.
7. Once the channel search is complete, select **[Finish]**, then press **OK**.

Tip: Press **≡ LIST** to see the channel list.

Note: When digital TV channels are found, the list of installed channels may display empty channel numbers. You can rename or reorder these channels.

Install analogue channels

You can search and store analogue TV channels one by one.

Step 1: Select your system

Note: Skip this step if your system settings are correct.

1. While you watch TV, press **⏏**.
2. Select **[Setup]** > **[Channel settings]** > **[Channel installation]**.
3. Select **[Analogue: Manual installation]** > **[System]**, then press **OK**.
4. Select the system for your country or region, then press **OK**.

Step 2: Search and store new TV channels

1. While you watch TV, press **⏏**.
2. Select **[Setup]** > **[Channel settings]** > **[Channel installation]**.
3. Select **[Analogue: Manual installation]** > **[Search channel]**, then press **OK**.
4. Find the channel:
 - If you know the channel frequency, enter it with the **Navigation buttons** or **Numeric buttons**.
 - If you do not know the channel frequency, search for the next frequency that has a strong signal. Select **[Search]**, then press **OK**.
5. After you have found the correct channel, select **[Done]**, then press **OK**.
6. Select **[Store as new channel]**, then press **OK** to store the new TV channel.

Note: If the reception is poor, reposition your antenna and repeat the procedure.

Install digital channels

If you know the channel frequency of the channels you want to install, you can search and store digital channels one by one. For best results, contact the service provider.

1. Press **⏏**.
2. Select **[Setup]** > **[Channel settings]** > **[Channel installation]**.
3. Select **[Digital: Reception test]** > **[Search channel]**, then press **OK**.
4. Press the **Numeric buttons** to enter the channel frequency.
5. Select **[Search]**, then press **OK**.
6. When the channel is found, select **[Store]**, then press **OK**.

Fine-tune analogue channels

If the reception of an analogue TV channel is poor, you can fine-tune the TV channel.

1. Press **⏏**.
2. Select **[Setup]** > **[Channel settings]** > **[Channel installation]**.
3. Select **[Analogue: Manual installation]** > **[Fine tune]**, then press **OK**.
4. Press **▲** or **▼** to fine-tune the channel.

5. When you have selected the correct channel frequency, select **[Done]**, then press **OK**.
6. Select an option, then press **OK**.
 - **[Store current channel]**: Store the channel under the current channel number.
 - **[Store as new channel]**: Store the channel under a new channel number.

Update channel list

When the TV was switched on for the first time, a full installation of channels was performed. By default, when there are changes to these channel lists, the TV updates them automatically. You can also switch off the automatic update or manually update the channels.

Note: If you are prompted to enter a code, enter '8888'.

Automatic update

To add or remove digital channels automatically, leave the TV in standby mode. The TV updates channels and stores new channels everyday. Empty channels are removed from the channel list.

Switch off the channel update message

If a channel update is performed, a message is displayed at startup. You can switch off this message.

1. Press **⏠**.
2. Select **[Setup] > [Channel settings] or [Satellite settings]**.
3. Select **[Channel installation] > [Channel update message]**.
4. Select **[Off]**, then press **OK**.

Switch off automatic updates

In the **[Channel installation]** menu, select **[Automatic channel update] > [Off]**.

Update channels manually

1. Press **⏠**.
2. Select **[Setup] > [Search for channels] > [Update channels]**, then press **OK**.
3. Follow the onscreen instructions to update the channels.

Copy channels

ATTENTION: This feature is intended for dealers and service personnel.

You can copy channel lists from one Philips TV to another through a USB storage device. You do not need to search for channels or install them again on the second TV. The channel list file is small enough to fit on any USB storage device.

What you need

Two Philips TVs that have these properties:

- The same country setting
- The same year range
- The same DVB type, as indicated by the suffix (H, K, T, D/00) in the model name
- The same settings for satellite channels, including the number of LNB satellites
- The same hardware type, as indicated by the sticker on the back of the TV. For example: TPM10.1E LA.
- Compatible software versions

Note: If you are prompted to enter a code, enter '8888'.

Step 1: Check the country setting

1. Switch on the first TV (with the channels that you want to copy to the second TV).
2. Press **⏠**.
3. Select **[Setup] > [Search for channels] > [Reinstall channels]**, then press **OK**.
The country menu is displayed.
4. Make a note of the current setting.
5. Press **↩**.
6. Press **[Cancel]** to exit.

Step 2: Copy channel list to USB

1. Connect a USB storage device to the first TV (with the channels installed on it).
2. Press **⏠**.
3. Select **[Setup] > [Channel settings] or [Satellite settings]**.
4. Select **[Channel installation] > [Copy channel list] > [Copy to USB]**, then press **OK**.

The channel list is copied to the USB storage device.

5. Disconnect the USB storage device.

Step 3: Copy channels to a TV with no channels installed

1. Switch on the second TV, on which you want to copy the channel list. Initial installation starts.

2. Follow the onscreen instructions and select the same country as the TV whose channel list you want to copy.

3. Skip the search for channels.

4. Connect the USB storage device.

5. Press **⬆**.

6. Select **[Setup] > [Channel settings] or [Satellite settings]**.

7. Select **[Channel installation] > [Copy channel list] > [Copy to TV]**, then press **OK**.

The channel list is copied to the TV storage device.

8. Disconnect the USB storage device.

Step 3: Copy channels to a TV with pre-installed channels

1. Switch on the second TV, on which you want to copy the channel list.

2. Press **⬆**.

3. Select **[Setup] > [Search for channels] > [Reinstall channels]**, then press **OK**.

The country menu is displayed.

4. Make sure that the country setting is the same as for the first TV.

5. Press **↩**.

6. Press **[Cancel]** to exit.

7. If the country setting is different, reinstall the second TV to match the country setting of the first TV. See **Change your TV settings > Reset all** (Page 36).

8. Connect the USB storage device to the second TV.

9. Press **⬆**.

10. Select **[Setup] > [Channel settings] or [Satellite settings]**.

11. Select **[Channel installation] > [Copy channel list] > [Copy to TV]**, then press **OK**.

The channel list is copied to the second TV.

12. Disconnect the USB storage device.

Satellite settings

What you can do

This TV can receive signals from 4 different low noise block-down converters (LNBs). An LNB is mounted at the end pole of the dish antenna and captures signals from a satellite.

Note:

- Satellite reception is available for certain models only. **[Search for satellite]** is only available if the TV supports DVB-S.
- To receive satellite channels, connect a satellite receiver to the SAT connector on your TV.

Install satellite channels

Reinstall satellites

1. While you watch TV, press **⬆**.

2. Select **[Setup] > [Search for satellite] > [Reinstall satellites]**.

3. Follow the onscreen instructions to complete the installation.

4. Once complete, select **[Finish]**, then press **OK**.

Select connection type

When you install satellite channels, you need to set the connection type. The number of LNBs on your dish antenna determines the number of satellite channels you can install.

1. While you reinstall satellites, select **[Settings]**, then press **OK**.

2. Select **[Connection type]**.

3. Select a setting, then press **OK**.

- **[1 satellite (Single LNB)]**: Select if you have only one LNB.
- **[2 satellites (DiSEqC Mini)]**: Select if you have 2 LNBs.
- **[3 or 4 satellites (DiSEqC 1.0)]**: Select for 3 or 4 LNBs.
- **[Unicable for 1 satellite]**: Select if you have a Unicable setup with 1 satellite.
- **[Unicable for 2 satellites]**: Select if you have a Unicable setup with 2 satellite.

Manual installation

If a transponder is skipped during installation, you can test the signal strength of a transponder or add a new transponder.

1. While you watch TV, press **🏠**.
2. Select **[Setup] > [Search for satellite] > [Manual installation]**, then press **OK**.
3. Select the LNB.
4. If you know the frequency of the transponder (which can include several channels), select **[Frequency]** and set the frequency.
5. Select **[Search]**, then press **OK**.
6. If a new frequency is found, press **[Store]** to add the new transponder with its channels.

Update satellite channels

1. While you watch TV, press **🏠**.
2. Select **[Setup] > [Search for satellite] > [Update channels]**.
3. Follow the onscreen instructions to complete the installation.
4. Once complete, select **[Finish]**, and then press **OK**.

Add and remove satellites

You can add or remove satellites at any time, and install channels from new satellites.

Note: Before you add satellites, make sure that the connection type is correct. See **Change your TV settings > Satellite Settings > Install satellite channels** (Page 32).

1. Press **🏠**.
2. Select **[Setup] > [Search for satellite]**, then press **OK**.
3. Select **[Add satellite]**, then press **OK**.
The TV searches for a satellite on the first free LNB. This can take several minutes.
4. If no satellite is found, check the antenna connections and the position of the dish antenna, then select **[Search again]**.
5. If you are satisfied with the added satellite, select **[Next]** to install all channels from the satellite.

The installation can take several minutes.

Remove a satellite

1. Press **🏠**.
2. Select **[Setup] > [Search for satellite] > [Remove satellite]**, then press **OK**.
3. Select the satellites you want to remove, then select **[Remove]** and press **OK**.

Language settings

Menu language

1. While you watch TV, press **🏠**.
2. Select **[Setup] > [TV settings] > [General settings] > [Menu language]**.
3. Select a menu language from the list, then press **OK**.

Audio language

If the TV channel broadcasts multiple or dual audio languages, you can select your preferred audio language.

1. While you watch TV, press **≡ OPTIONS**.
2. For digital channels, select **[Audio language]**. For analogue channels, select **[Dual I-II]**. Press **OK** to confirm your selection.
3. Select from the available languages, then press **OK**.

You can set your preferred primary and secondary audio languages to hear when available.

1. While you watch TV, press **🏠**.
2. Select **[Setup] > [Channel settings] or [Satellite settings] > [Languages]**.
3. Select **[Primary audio language] or [Secondary audio language]** and select from the available languages.
4. Press **OK** to confirm.

Subtitles on analogue channels

1. While you watch an analogue TV channel, press **TEXT**.
 2. Enter the three-digit page number of the subtitles page, which is usually '888'.
- If available, subtitles are switched on.

Subtitles on digital channels

1. While you watch a digital TV channel, press **III** **OPTIONS**.
2. Select **[Subtitles]**, then press **OK**.
3. Select **[Subtitles off]**, **[Subtitles on]** or **[Automatic]**, then press **OK**.

Subtitle language

When available, you can change the subtitle language for digital channels.

1. While you watch TV, press **III** **OPTIONS**.
2. Select **[Subtitle language]**, then select from the available languages and press **OK**.

The subtitle language is changed for the specific channel.

You can set your preferred primary and secondary subtitle languages to display when available.

1. While you watch TV, press **🏠**.
2. Select **[Setup]** > **[Channel settings]** or **[Satellite settings]** > **[Languages]**.
3. Select **[Primary subtitle language]** or **[Secondary subtitle language]** and select from the available languages.
4. Press **OK** to confirm.

Universal access settings

Switch on

Some digital TV broadcasters provide special audio and subtitle features for people who are hearing or visually impaired. You can switch these features on or off.

1. Press **🏠**.
2. Select **[Setup]** > **[TV settings]** > **[General settings]**.
3. Select **[Universal access]** > **[On]** or **[Off]**, then press **OK**.

Set audio feedback

When you press a button on the remote control or TV, you can set the TV to play a beep.

1. While you watch TV, press **III** **OPTIONS**.
2. Select **[Universal access]** > **[Key beep]** > **[On]**, then press **OK**.

Hearing impaired access

To make sure that a hearing-impaired audio language is available, press **III** **OPTIONS**, then select **[Audio language]**. Languages that support hearing-impaired audio are indicated with an ear-shaped icon.

Switch on hearing-impaired audio and subtitles

1. While you watch TV, press **III** **OPTIONS**.
2. Select **[Universal access]** > **[Hearing impaired]**.
3. Select a setting, then press **OK**.
 - **[Off]**: Switch off hearing impaired features.
 - **[On]**: Switch on hearing impaired audio and subtitles.

Visually impaired access

To make sure that a hearing-impaired audio language is available, press **III** **OPTIONS**, then select **[Audio language]**. Languages that support visually impaired audio are indicated with an eye-shaped icon.

Select speakers or headphones

You can choose to hear the visually impaired audio through the TV speakers, headphones or both.

1. While you watch TV, press **III** **OPTIONS**.
2. Select **[Universal access]** > **[Visually impaired]**.
3. Select a setting, then press **OK**.

- **[Speakers]**: Hear visually impaired audio from speakers only.
- **[Headphones]**: Hear visually impaired audio from headphones only.
- **[Speakers + headphones]**: Hear visually impaired audio from speakers as well as headphones.
- **[Off]**: Switch off visually impaired audio.

Note: If the EasyLink remote control is switched on, you cannot select the Green button. To switch off EasyLink, see **Connect your TV > Set up EasyLink devices > What you need** (Page 47).

Change volume for visually impaired audio

1. While you watch TV, press **III** **OPTIONS**.
2. Select **[Universal access]** > **[Mixed volume]**.
3. Press the **Navigation** buttons to change the volume, then press **OK**.

Audio effects

1. Press **🏠**.
2. Select **[Setup]** > **[Channel settings]** or **[Satellite settings]**.
3. Select **[Languages]** > **[Visually impaired]** or **[Audio effects]**.
4. Select a setting, then press **OK**.
 - **[On]**: Enable audio effects in the visually impaired audio.
 - **[Off]**: Disable audio effects in the visually impaired audio.

Type of speech

1. Press **🏠**.
2. Select **[Setup]** > **[Channel settings]** or **[Satellite settings]**.
3. Select **[Languages]** > **[Visually impaired]** or **[Speech]**.
4. Select a setting, then press **OK**.
 - **[Descriptive]**: Hear descriptive speech in the visually impaired audio.
 - **[Subtitles]**: Hear subtitles in the visually impaired audio.

Other settings

TV demo

You can watch a demo to find out more about the features on this TV.

1. While you watch TV, press **🏠**.
2. Select **[Setup]** > **[Watch demos]**, then press **OK**.
3. Select a demo, then press **OK**.

Home mode

Some TV settings may not be available in **Shop** mode. To make sure that the correct TV settings are applied, set the TV to **Home** mode.

1. While you watch TV, press **🏠**.
2. Select **[Setup]**, then press **OK**.
3. Select **[TV settings]** > **[General settings]** > **[Location]**.
4. Select **[Home]** or **[Shop]**, then press **OK**.
5. Restart the TV.

Update software

Check version

1. Press **🏠**.
2. Select **[Setup]** > **[Software settings]** > **[Current software inf]**, then press **OK**.

The current software version is displayed.

Caution: Do not install a lower version of software than the current version installed on your product. TP Vision cannot be held liable or be made responsible for problems caused by a software downgrade.

Update the software through one of these methods:

- update with USB storage device
- update from digital broadcast

Update with USB

What you need

- A USB storage device that has at least 256 megabytes of storage space, is FAT or DOS formatted and has its write protection disabled.
- Access to a computer with a USB connector and Internet access.
- A file archiver program that supports the ZIP file format: for example, WinZip® for Microsoft® Windows® or Stuffit® for Macintosh®.

Note: Do not use a USB hard drive.

Download the latest software

1. Connect the USB flash drive to your computer.
2. On your computer, launch a browser such as Internet Explorer® or Safari®, and see www.philips.com/support.
3. Find your TV and locate the software and drivers available for your TV set. The software upgrade is available as a compressed file (*.zip).
4. If the software version is higher than the version on your TV, click the software upgrade link.
5. Accept the licence agreement and download the ZIP file to the USB flash drive.

Note: Some Internet browsers, such as Mozilla® Firefox® or Google® Chrome®, may download the ZIP file directly to your computer. If this happens, copy the file to your USB flash drive.

6. For Internet Explorer: Using a file archiver, extract autorun.upg from the downloaded ZIP file. Do not copy or place the extracted file into a folder.



6. For Safari: When the download is complete, autorun.upg is automatically extracted from the ZIP file to your computer. Copy the file to the USB flash drive. Do not copy or place the file into a folder.

7. Eject and disconnect the USB flash drive from the computer.

Upgrade the TV software

Caution:

- Do not switch off the TV or remove the USB flash drive during the software upgrade.
- If a power failure occurs during the upgrade, do not remove the USB flash drive from the TV. The TV continues the upgrade as soon as power is restored.
- If an error occurs during the upgrade, retry the upgrade from the beginning. If the error reoccurs, contact Philips Consumer Care.

1. Remove all USB devices such as a Wi-Fi adapter from the TV, then switch on the TV.
2. Connect the USB flash drive to the TV. The software upgrade starts automatically. The upgrade is complete when a notification message appears on screen.
3. Before you restart the TV, disconnect the USB flash drive from the TV.
4. Press  on the remote control – do not press  more than once. The TV switches off, then back on again. The upgrade is complete.
5. To prevent accidental updates to the TV software, reconnect the USB flash drive to your computer and delete autorun.upg.

Update from digital broadcast

When available, the TV can receive software updates through digital broadcasts. When a software update is received, you are prompted to update the software. We strongly recommend that you update the software when prompted.

Follow the onscreen instructions.

If you do not update the TV software when the update is received, you are prompted to save the update file. To update the software later:

1. Press .
2. Select **[Setup] > [Software settings] > [Local updates]**.
3. Select the file that you downloaded and follow the onscreen instructions to complete the update.

Reset all

You can reset all picture and sound settings and reinstall all TV channels on your TV.

1. Press .
2. Select **[Setup] > [TV settings] > [General settings] > [Reinstall TV]**, then press **OK**.
3. Follow the onscreen instructions.

5 Connect your TV

About cables

Cable quality

Before you connect devices to the TV, check the available connectors on the device. Connect the device to the TV with the highest quality connection available. Good quality connectors transfer picture and sound better.

The connections shown in this user manual are recommendations only. Other solutions are possible. For more examples, visit <http://www.connectivityguide.philips.com>.

Tip: If your device has only composite or RCA connectors, use a composite (CVBS) cable to connect the device to the CVBS/Y connector on the TV.

HDMI

An HDMI connection has the best picture and sound quality.

- An HDMI cable combines video and audio signals. Connect HDMI for high-definition (HD) TV signals, and to switch on EasyLink.
- An HDMI Audio Return Channel (ARC) connector allows output of TV audio to an HDMI ARC compliant device.
- Connect HDMI cables shorter than 5 meters/16.4 feet.

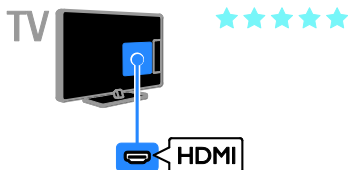

Y Pb Pr

Component video (Y Pb Pr) only transmits video. For sound, also connect to Audio Left/Right.

- The Y Pb Pr connection can handle high-definition (HD) TV signals.
- Match the Y Pb Pr connector colours to the cable plugs.

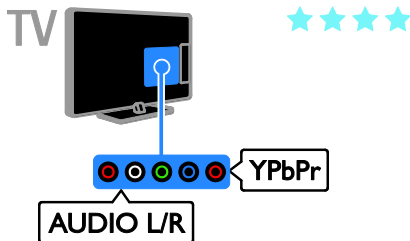

SCART

A SCART connection combines video and audio signals.

SCART connectors can handle RGB video signals but cannot handle high-definition (HD) TV signals.

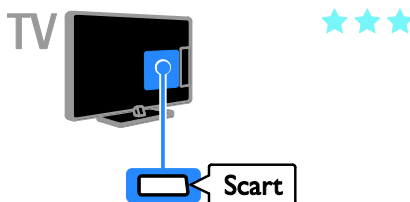

Connect antenna

Connect the antenna to the TV.

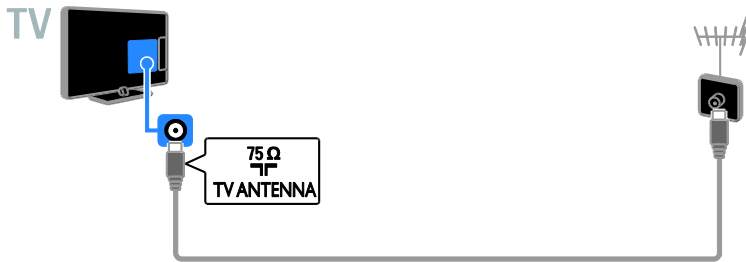

Connect devices

Blu-ray or DVD disc player

Connect the disc player with an HDMI cable to the TV.

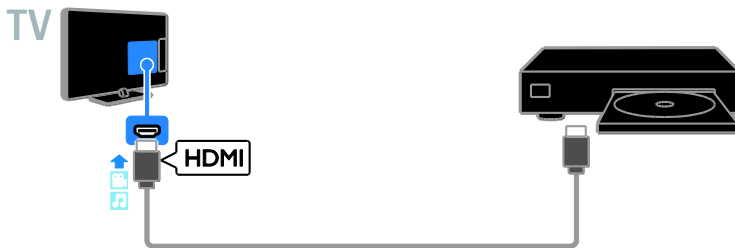

Connect the disc player to the TV with a component video cable (Y Pb Pr) and an audio L/R cable.



TV receiver

Connect the satellite* or digital TV receiver to the TV with an antenna cable.
*For certain models only.

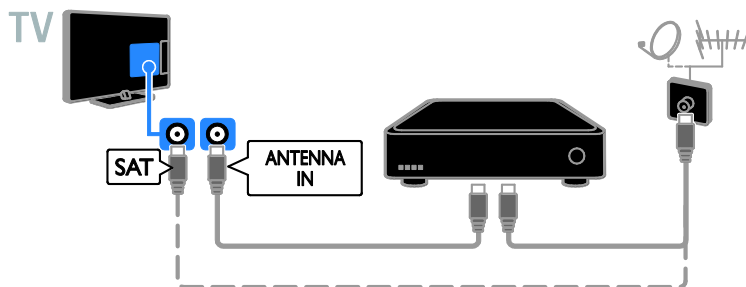

Connect the satellite or digital TV receiver to the TV with an HDMI cable.



Connect the digital TV receiver to the TV with a component video cable (Y Pb Pr) and an audio L/R cable.

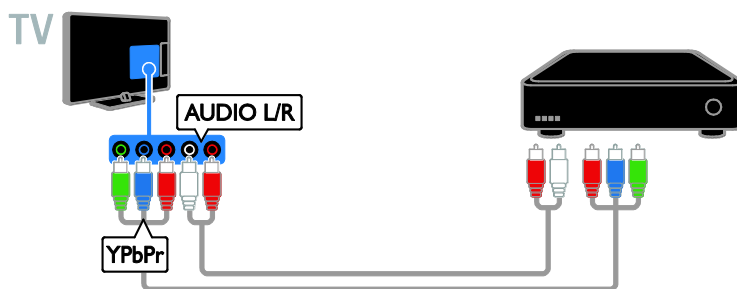

Connect the digital TV receiver to the TV with a SCART cable.

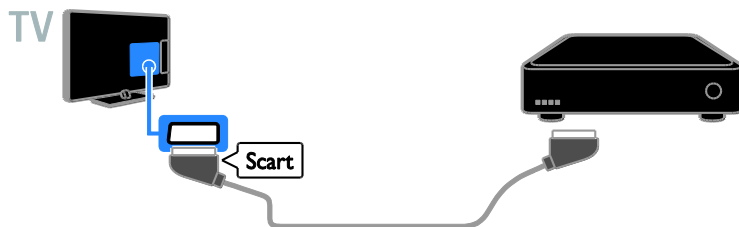

Video recorder

Connect the recorder to the TV with an antenna cable.

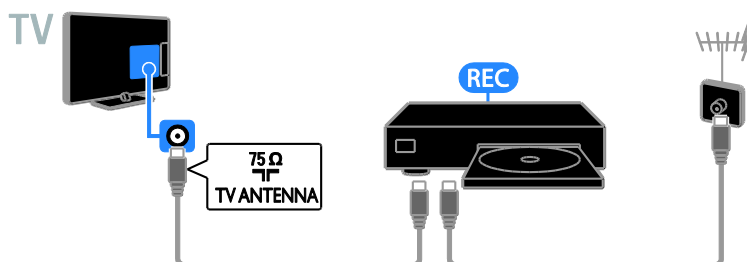

Connect the recorder to the TV with an HDMI cable.



Connect the recorder to the TV with a component video cable (Y Pb Pr) and an audio L/R cable.



Connect the recorder to the TV with a SCART cable.

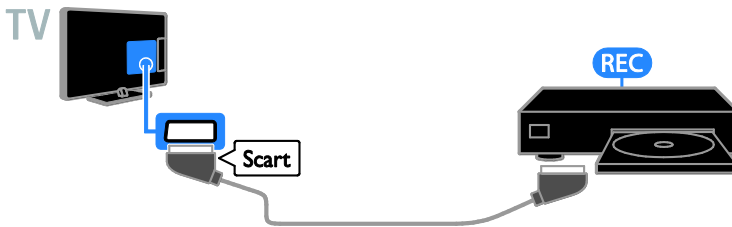

Game console

Connect the game console with an HDMI cable to the TV.



Connect the game console to the TV with a component video cable (Y Pb Pr) and an audio L/R cable.

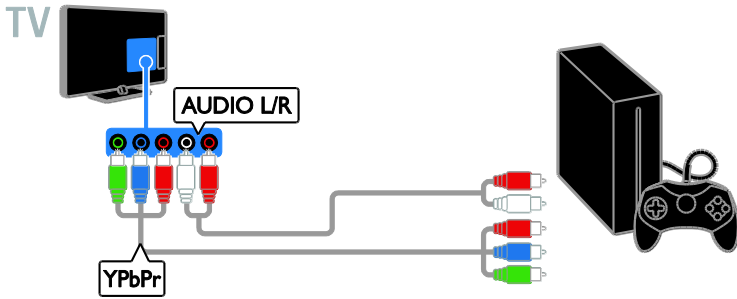

Home theatre

Connect an HDMI-ARC compliant home theatre to the TV with an HDMI cable.

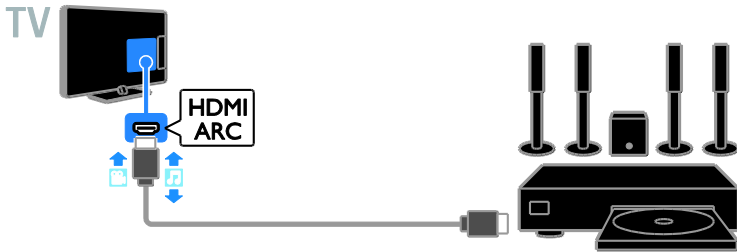

Connect the home theatre to the TV with an HDMI cable and a coaxial audio cable.

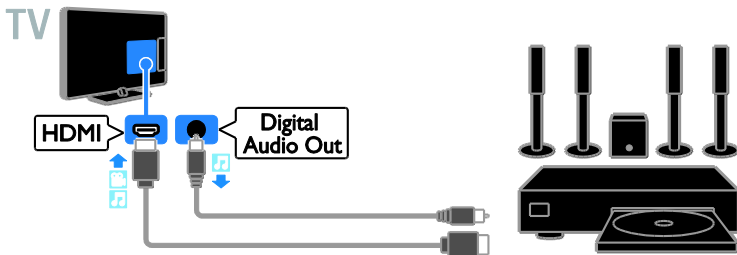

Connect the home theatre to the TV with a component video cable (Y Pb Pr) and an audio L/R cable.

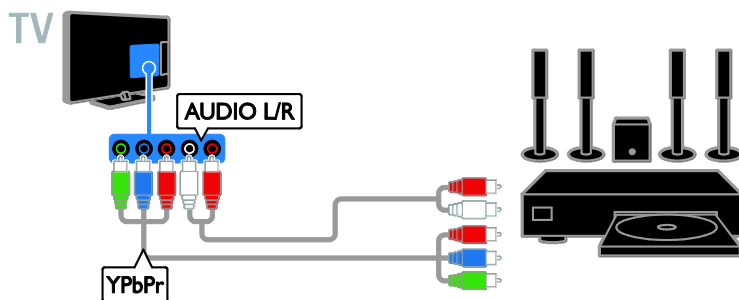

Connect the home theatre to the TV with a SCART cable.

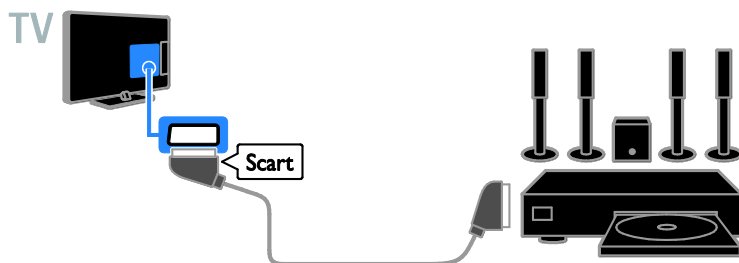

Digital camera

Connect the digital camera to the TV with a USB cable.



Digital camcorder

Connect the digital camcorder to the TV with an HDMI cable.



Connect the digital camcorder to the TV with a component video cable (Y Pb Pr) and an audio L/R cable.

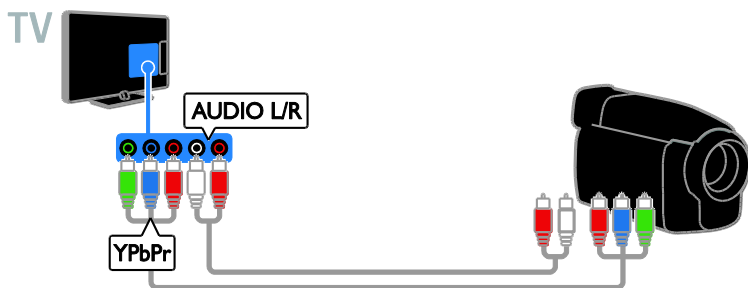

Connect more devices

USB storage device

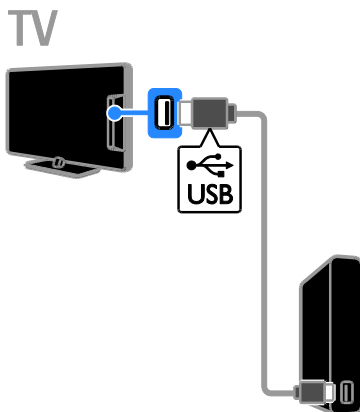

Connect the USB hard drive to the TV with a USB cable.

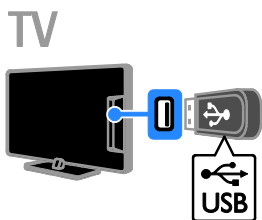

Connect the USB flash drive with a USB cable to the TV.

Computer

Connect the computer to the TV with an HDMI cable.



Connect the computer to the TV with a DVI-HDMI cable and an audio cable.

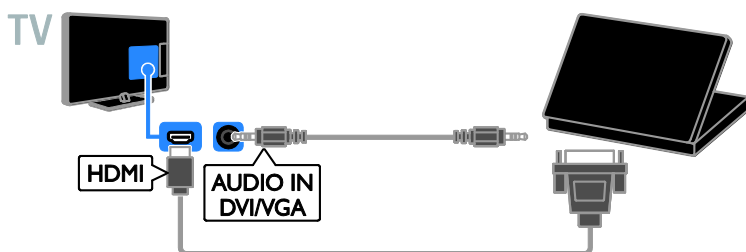

Watch connected devices

Select a device

Before you can watch a device, connect the device to the TV. See **Connect your TV > Connect devices** (Page 38).

Select a device with SOURCE

1. Press  **SOURCE**.
2. Select a device, then press **OK**.

Select a device from Home menu

1. Press .
2. Select **[Source]**, then press **OK**.
3. Select a device, then press **OK**.

Change device settings

Change the device type

You can change the device type to easily access it from the Source menu.

1. Press  **SOURCE**.
2. Select the device, then press **[Device type]**.
3. Select a suitable device type, then press **OK**.

Rename a device

You can rename a device after it is connected to the TV.

1. Press  **SOURCE**.
2. Select the connector, then press **[Rename]**.
3. Use the on-screen keypad to enter a new name.
4. When complete, select **[Done]**, then press **OK**.

Reset device settings

You can reset the type and name of the device to default settings.

1. In the **[Source]** menu, select the device and press  **OPTIONS**.
2. Select **[Original name and icon]**, then press **OK**.

Set up EasyLink devices

What you can do

You can get the most out of your HDMI-CEC-compliant devices with Philips EasyLink enhanced control features. Connect your HDMI-CEC compliant devices through HDMI to your TV and control them at the same time with your TV remote control.

Note: Other brands describe HDMI-CEC functionality differently. Some examples are Anynet (Samsung), Aquos Link (Sharp) or BRAVIA Sync (Sony). Not all brands are fully compatible with Philips EasyLink.

After you have switched on Philips EasyLink, the following features are available:

One-touch play

When you play an HDMI-CEC compliant device, the TV switches on from standby and switches to the correct source.

One-touch standby

When you press  on the TV remote control, the TV and all HDMI-CEC compliant devices switch to standby mode.

Auto switch off inactive devices

If a HDMI-CEC compliant device has been inactive for some time, it switches to standby mode.

EasyLink remote control

You can control multiple HDMI-CEC compliant devices with your TV remote control.

System audio control

If you connect an HDMI-CEC compliant device that includes speakers through the HDMI ARC connector, you can choose to hear the TV audio from those speakers instead of the TV speakers.

Retain picture quality

If your TV picture quality is affected by the picture-processing features of other devices, you can switch on Pixel Plus Link to retain picture quality.

Maximise display for subtitled video

Some video subtitles can create a separate subtitle bar under the video, which limits the video display area. To maximise the video display area, you can switch on auto subtitle shift and display the subtitles on the video image.

What you need

- Connect an HDMI-CEC compliant device to the TV. You can connect more than one HDMI-CEC device. See **Connect your TV > Connect devices** (Page 38).
- Configure each HDMI-CEC compliant device properly.
- Switch on EasyLink.

Switch on EasyLink

1. Press .
2. Select **[Setup]** > **[TV settings]** > **[General settings]** > **[EasyLink]**.
3. Select **[EasyLink]** > **[On]**, then press **OK**.



Control devices

If you connect multiple HDMI-CEC devices that support this setting, you can control all such devices through the TV remote control.

Note: This is an advanced setting. Devices that do not support this setting cannot respond to the TV remote control.



1. Press .
2. Select **[Setup]** > **[TV settings]** > **[General settings]** > **[EasyLink]** > **[EasyLink remote control]**.
3. Select **[On]** or **[Off]**, then press **OK**.

Tips:

- To switch back to TV control, press , then select **[Watch TV]**.
- To control another device, press , then select the device from the Home menu.

EasyLink buttons



You can control HDMI-CEC compliant devices with the following buttons on the TV remote control:

- : Switch the TV and the connected device on or to standby.
- **Play buttons:** Control video or music play.
- **Numeric buttons:** Select a title, chapter or track.
- **OK:** Start, pause or resume play on the connected device, activate a selection, or access the device menu.
- : Display the TV Home menu.

On-Screen Remote Control (OSRC)

You can also control devices through other EasyLink buttons that are available through the On-Screen Remote Control.

To access the OSRC

1. While you watch a connected device, press  **OPTIONS**.
2. Select **[Controls]**, then press **OK**.
3. Select an onscreen button, then press **OK**.
4. Press  to exit.

Switch off connecting devices

You can also set the TV to switch off the connecting HDMI-CEC compliant devices if they are not the active source. The TV switches the connecting device to standby after 10 minutes of inactivity.

1. Press .
2. Select **[Setup]** > **[TV settings]** > **[General settings]** > **[EasyLink]**.
3. Select **[Auto switch off devices]** > **[On]**, then press **OK**.

Select speaker output

If a connected device is HDMI Audio Return Channel (HDMI ARC) compliant, you can output TV audio through an HDMI cable. Additional audio cables are not required. Make sure you connect the device to the HDMI ARC connector on the TV. See **Connect your TV > About cables > HDMI** (Page 37).

Switch on HDMI ARC

1. Press .
2. Select **[Setup] > [TV settings] > [Sound] > [Advanced] > [HDMI 1 - ARC]**.
3. Select one of the following, then press **OK**.
 - **[On]**: Hear the TV audio through the connected HDMI-ARC compliant device.
 - **[Off]**: Hear the TV audio through the TV speakers, or through a device connected through the digital audio out connector.

Note: Make sure that all HDMI-CEC settings are properly set up on the connected device.

Set up TV speakers

1. Press .
2. Select **[Setup] > [TV settings] > [Sound] > [Advanced] > [TV speakers]**.
3. Select an option, then press **OK**:
 - **[Off]**: Switch off TV speakers.
 - **[On]**: Switch on TV speakers.
 - **[EasyLink]**: Switch off TV speakers and stream TV audio to a connected HDMI-CEC audio device.
 - **[EasyLink autostart]**: When a HDMI-CEC audio device is connected, automatically switch off TV speakers and stream TV audio to the device.

Change TV audio streaming

You can switch audio between TV speakers and a connected amplifier at any time.

1. Press  **OPTIONS**.
2. Select **[Picture and sound] > [Speakers]**.
3. Select one of the following, then press **OK**.
 - **[TV]**: On by default.
Stream TV audio through TV and the connected HDMI-CEC audio device until the connected device switches to system audio control. TV audio is then streamed through the connected device.
 - **[Amplifier]**: Stream audio through the connected HDMI-CEC device. If system audio mode is not enabled on the device, audio continues to stream from the TV speakers. If **[EasyLink autostart]** was selected, the TV prompts the connected device to switch to system audio mode.

Retain picture quality

If your TV picture quality is affected by the picture-processing features of other devices, you can switch on Pixel Plus Link.

Switch on Pixel Plus Link

1. Press .
2. Select **[Setup] > [TV settings] > [General settings] > [EasyLink]**.
3. Select **[Pixel Plus Link] > [On]**, then press **OK**.

Maximise video display

Some subtitles create a separate subtitle bar under the video that limits the video display area. To maximise the video display area, you can switch on auto subtitle shift. The subtitles are then displayed over the video image.

Switch on auto subtitle shift

1. Press .
2. Select **[Setup] > [TV settings] > [General settings] > [EasyLink]**.
3. Select **[Auto subtitle shift] > [On]**, then press **OK**.

Connect a CAM (Conditional Access Module)

What you can do

You can watch scrambled digital TV channels with a Conditional Access Module (CAM). Once you have inserted the CAM and paid the subscription fees, you can watch the programmes.

This TV supports CI (Common Interface) as well as CI+. CI+ supports premium HD digital programmes with a high level of copy protection.

Note: The applications, functions, content and onscreen messages depend on the CAM service provider.

What you need

Caution: To protect the CAM from damage, insert the CAM as instructed.

Note: Refer to the documentation from your service operator on how to insert a smart card into the Conditional Access Module.

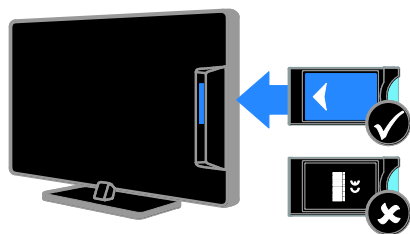

1. Switch off the TV.
2. Follow the directions printed on the CAM to insert the CAM into the Common Interface slot at the side of the TV. Push the CAM in as far as it will go.
3. Switch on the TV, then wait for the CAM to be activated. This takes a few minutes. To maintain access to encrypted digital TV channels, leave the CAM in the slot.

Access CAM services

1. After you insert and activate the CAM, press **III** **OPTIONS**.
2. Select **[Common interface]**, then press **OK**.
3. Select the CAM provider, then press **OK**.

6 Troubleshooting

General issues

The TV does not switch on:

- Disconnect the power cable from the power outlet. Wait for one minute then reconnect it.
- Make sure that the power cable is securely connected.

When you are turning the TV on, off or to standby, you hear a creaking sound from the TV chassis:

No action is required. The creaking sound is due to the normal expansion and contraction of the TV as it cools and warms up. This does not affect performance.

The TV does not respond to remote control or TV controls when switched on:

The TV requires some time to start up. During this time, the TV does not respond to the remote control or TV controls. This is normal behaviour.

If the TV continues to be unresponsive to the remote control, view the remote control sensor through a digital camera – if you press any button on the remote control and notice red flickering at the sensor, the remote control is working but the TV may need to be checked by Philips Consumer Care. This troubleshooting procedure is not applicable to remote controls that are paired wirelessly with the TV.

When the TV is in standby, a start-up splash screen is displayed, then the TV returns to standby mode:



This is normal behaviour. When the TV is disconnected and reconnected to the power supply, the startup screen is displayed at the next startup.

To switch on the TV from standby, press  on the remote control or press any key on the TV.

The standby light on the TV blinks red:

Disconnect the power cable from the power outlet. Wait until the TV cools down before you reconnect the power cable. If the blinking reoccurs, contact Philips Consumer Care.

The TV audio is in the wrong language:

If you select audio language via  **OPTIONS**, the TV resets to the default language when you change channels or switch off the TV. To retain the selected language, change your audio language by pressing , then selecting **[Setup] > [Channel settings] or [Satellite settings] > [Languages] > [Primary audio language] or [Secondary audio language]**.

The TV or Smart TV menu is in the wrong language:

Change the menu to your preferred language.
For more information, see **Change your TV settings > Language settings > Menu language** (Page 33).

You forgot the 4-digit code to unlock the channel blocking feature (child lock):

Enter '8888'.

You want to upgrade your TV software:

Visit www.philips.com/support and download the latest software package for your TV. Software installation instructions and release notes indicating what's been updated are also available at the site. Full instructions on how to upgrade your TV software are also available at **Change your TV settings > Update software** (Page 35).

Channel issues

You want to install TV channels:

See **Change your TV settings > Automatic installation** (Page 30) for instructions on installing analogue or digital channels. If you want to install satellite TV channels, see **Change your TV settings > Satellite settings** (Page 32).

No digital channels were found during the installation:

- See the technical specifications to make sure that your TV supports DVB-T, DVB-C or DVB-S in your country.
- Make sure that all cables are properly connected and that the correct network is selected.

Previously installed channels do not appear in the channel list:

Make sure that the correct channel list is selected.

You want to rearrange or reorder the channel list:

After channels have been installed, they appear in the channel list. For information about managing channel lists, including rearranging channels, see **Watch TV > Manage channel lists** (Page 13).

Picture issues

The TV is on, but there is no picture or the picture is distorted:

- Make sure that the antenna is properly connected to the TV.
- Make sure that the correct device is selected as the display source.
- Make sure that the external device or source is properly connected.

There is sound but no picture:

Make sure that the picture settings are set correctly.

There is poor TV reception from an antenna connection:

- Make sure that the antenna is properly connected to the TV.
- Loud speakers, unearthed audio devices, neon lights, high buildings and other large objects can influence reception quality. If possible, try to improve the reception quality by changing the antenna direction or moving devices away from the TV.
- If reception on only one channel is poor, fine-tune this channel.

There is poor picture quality from connected devices:

- Make sure that the devices are connected properly.
- Make sure that the picture settings are set correctly.

The TV did not save your picture settings:

Make sure that the TV location is set to **Home**. You can change and save settings in this mode.

The picture does not fit the screen; it is too big or too small:

Change to a different picture format.

The picture format keeps changing with different channels:

Instead of the picture format **[Auto zoom]**, select a different picture format.

The picture position is incorrect:

Picture signals from some devices may not fit the screen correctly. Check the signal output of the device.

The picture from broadcasts is scrambled:

You may need a Conditional Access Module to access content. Check with your service operator.

An "e-sticker" banner displaying information appears on the TV display:

The TV is in **[Shop]** mode. To remove the e-sticker, set the TV to **[Home]** mode, then restart the TV. See **Change your TV settings > Other settings > Home mode** (Page 35).

The computer display on the TV is not stable:

- Make sure that your PC uses the supported resolution and refresh rate. See **Specifications > Display resolutions** (Page 54).
- Change the TV picture format to **[Unscaled]**.

Sound issues

There is a picture but sound quality is poor:

If no audio signal is detected, the TV automatically switches the audio output off — this does not indicate malfunction.

- Make sure that all cables are properly connected.
- Make sure that the volume is not muted or set to zero.
- Make sure that the TV speaker setting is selected. Press **III OPTIONS**, select **[Picture and sound] > [Speakers]**, then select **[TV]**.
- Make sure that the TV audio output is connected to the audio input on the HDMI-CEC enabled or EasyLink compliant home theatre device. Sound should be heard from the home theatre speakers.
- Some devices may require you to manually enable HDMI audio output. If HDMI audio is already enabled, but you still do not hear audio, try changing the digital audio format of the device to PCM (Pulse Code Modulation). Refer to the documentation accompanying your device for instructions.

There is a picture but the sound quality is poor:

Make sure that the sound settings are correctly set.

Connection issues

There are problems with HDMI devices:

- Note that HDCP (High-bandwidth Digital Content Protection) support can delay the time taken for a TV to display content from an HDMI device.
- If the TV does not recognise the HDMI device and no picture is displayed, switch the source from one device to another and back again.
- If there are intermittent sound disruptions, make sure that output settings from the HDMI device are correct.
- If you use an HDMI-to-DVI adapter or HDMI to DVI cable, make sure that an additional audio cable is connected to **AUDIO L/R** or **AUDIO IN** (mini-jack only).

You cannot use EasyLink features:

Make sure that your HDMI devices are HDMI-CEC compatible. EasyLink features only work with devices that are HDMI-CEC compatible.

If an HDMI-CEC compliant audio device is connected to the TV and the TV does not display any mute or volume icon when the volume is muted, increased or decreased:

When a HDMI-CEC audio device is connected this behaviour is normal.

USB device content is not displayed:

- Make sure that the USB storage device is set to **Mass Storage Class** compliant, as described in the storage device's documentation.
- Make sure that the USB storage device is compatible with the TV.
- Make sure that the audio and picture file formats are supported by the TV.

Audio and picture files on your USB storage device do not play or display smoothly:

The transfer performance of the USB storage device may limit the data transfer rate to the TV which causes poor playback.

Contact Philips

Warning: Do not attempt to repair the TV yourself. This may cause severe injury, irreparable damage to your TV or void your warranty.

If you are not able to resolve your problem, refer to the frequently asked questions (FAQs) for this TV at www.philips.com/support. You can also consult and contribute to the Philips TV community at www.supportforum.philips.com.

If you wish to speak to or email a Philips representative, contact the Philips Consumer Care in your country. You can find the contact details in the leaflet accompanying this TV or at www.philips.com/support.

Note your TV model and serial number before you contact Philips. These numbers are printed on the back of the TV and on the packaging.

7 Specifications

Power and reception

Product specifications are subject to change without notice.

Power

- Mains power: AC 220-240 V (50-60 Hz)
- Standby power consumption: < 0.3 W
- Ambient temperature: 5 to 40 degree Celsius
- For power consumption, see the product specifications at www.philips.com/support.

The power rating stated on the product typeplate is the power consumption for this product during normal household use (IEC 62087 Ed.2). The maximum power rating, stated between brackets, is used for electrical safety (IEC 60065 Ed. 7.2).

Reception

- Antenna input: 75 ohm coaxial (IEC75)
- TV system: DVB COFDM 2K/8 K
- Video playback: NTSC, PAL, SECAM*
- Digital TV: MPEG-4, DVB-T (Terrestrial), DVB-T2*, DVB-C (Cable), DVB-S/S2* (Satellite)
- Tuner bands: VHF, UHF, S-Channel, Hyperband

*Available on certain models only.

Display and sound

Picture / Display

- Display type: LED backlight Full HD
- Diagonal size:
 - 81 cm / 32 inches
 - 99 cm / 39 inches
 - 102 cm / 40 inches
 - 107 cm / 42 inches
 - 117 cm / 46 inches
 - 127 cm / 50 inches
 - 140 cm / 55 inches

- Aspect ratio: 16:9 (widescreen)
- Panel resolution: 1920x1080p (Full HD)
- Picture enhancement: Pixel Precise
- Perfect Motion Rate (PMR):
 - For PFL43x8: 200 Hz
 - For PFL3xx8: 100 Hz
- For PFL43x8: 3D: 3D Max

Sound

- Output power (RMS):
 - PFL43x8/PFL31x8/PFL3018/PFL3028/PFL3058: 20 W @ 10% THD
 - PFL3078: 12 W @ 10% THD
- Clear Sound*
- Mono / Stereo / Secondary audio programming

*For certain models only.

Display resolutions

Computer formats - HDMI (Resolution - refresh rate)

640 × 480 - 60 Hz
800 × 600 - 60 Hz
1024 × 768 - 60 Hz
1280 × 720 - 60 Hz
1280 × 768 - 60 Hz
1280 × 1024 - 60 Hz
1360 × 768 - 60 Hz
1680 × 1050 - 60 Hz
1920 × 1080 - 60 Hz

Computer formats - VGA (Resolution - refresh rate)

640 × 480 - 60 Hz
800 × 600 - 60 Hz
1024 × 768 - 60 Hz
1280 × 1024 - 60 Hz
1360 × 768 - 60 Hz
1600 × 1200 - 60 Hz
1920 × 1080 - 60 Hz

Video formats

(Resolution - refresh rate)

480i - 60 Hz
 480p - 60 Hz
 576i - 50 Hz
 576p - 50 Hz
 720p - 50Hz, 60 Hz
 1080i - 50Hz, 60 Hz
 1080p - 24Hz, 25Hz, 30Hz, 50Hz, 60 Hz

Supported image files

- JPEG: *.jpg, *.jpeg, *.mpo, *.jps
- GIF (87a, 89a): *.gif
- PNG: *.png, *.pns
- BMP: *.bmp, *.dib
- JPS: *.jps
- PNS: *.pns
- BMS: *.bms

Multimedia

Supported multimedia connections

Note: Multimedia file names must not exceed 128 characters.

- USB: Connect only those USB devices that consume 500 mA of power or less.
 - NTFS, FAT 16 (Read only)
 - FAT 32
- Ethernet LAN RJ-45 (For certain models)

Supported audio/video formats

File Extensions	Container	Video codec	Maximum resolution	Max. Frame Rate (fps)	Max. Bit Rate (Mbps)	Audio codec	USB	Media server	CE-HTML	HTML5	YouTube
.mpg .mpeg .m2v	PS	MPEG-1	1920x1080	25p, 30p, 50i, 60i	30	MPEG-1 (L1&L2), MPEG-1,2,2.5 L3, AAC/HE-AAC (v1&v2), DVD-PCM, Dolby Digital	Yes	Yes	Yes	Yes	No
		MPEG-2	1920x1080	25p, 30p, 50i, 60i	30		Yes	Yes	Yes	Yes	No
		MPEG-4 ASP	1920x1080	25p, 30p, 50i, 60i	30		Yes	Yes	Yes	Yes	No
		H.264	1920x1080	25p, 30p, 50i, 60p, 60i	30		Yes	Yes	Yes	Yes	No
.as	TS	MPEG-2	1920x1080	25p, 30p, 50i, 60i	30	MPEG-1 (L1&L2), MPEG-1,2,2.5 L3, AAC/HE-AAC (v1&v2), Dolby Digital, Dolby Digital Plus, Dolby Pulse	Yes	Yes	Yes	Yes	No
		MPEG-4 ASP	1920x1080	25p, 30p, 50i, 60i	30		Yes	Yes	Yes	Yes	No
		H.264	1920x1080	25p, 30p, 50i, 60p, 60i	30		Yes	Yes	Yes	Yes	No
		MVC	1920x1080i @ 8640 reso = 50, 60Hz 1920x1080p @ frame rate = 24, 25, 30Hz 1280x720p @ frame rate = 50, 60Hz	-	30		Yes	Yes	Yes	Yes	No

Supported audio/video formats

File Extensions	Container	Video codec	Maximum resolution	Max. Frame Rate (fps)	Max. Bit Rate (Mbps)	Audio codec	USB	Media server	CE-HTML	HTML5	YouTube
.as .m2ts .mts .m2	M2TS TTS	MPEG-2	1920x1080	25p, 30p, 50i, 60i	30	MPEG-1 (L1&L2), MPEG-1,2,2.5 L3, AAC/HE-AAC (v1&v2), Dolby Digital, Dolby Digital Plus, Dolby Pulse	Yes	Yes	No	No	No
		MPEG-4 ASP	1920x1080	25p, 30p, 50i, 60i	30		Yes	Yes	No	No	No
		H.264	1920x1080	25p, 30p, 50i, 60p, 60i	30		Yes	Yes	No	No	No
		MVC	1920x1080i @ 8640 reso = 50, 60Hz 1920x1080p @ frame rate = 24, 25, 30Hz 1280x720p @ frame rate = 50, 60Hz	-	30		Yes	Yes	No	No	No
.as .m2ts .mts	AVCHD	MPEG-2	1920x1080	25p, 30p, 50i, 60i	30	MPEG-1 (L1&L2), MPEG-1,2,2.5 L3, AAC/HE-AAC (v1&v2), Dolby Digital, Dolby Digital Plus, Dolby Pulse	Yes	Yes	No	No	No
		MPEG-4 ASP	1920x1080	25p, 30p, 50i, 60i	30		Yes	Yes	No	No	No
		H.264	1920x1080	25p, 30p, 50i, 60p, 60i	30		Yes	Yes	No	No	No

Supported audio/video formats

File Extensions	Container	Video codec	Maximum resolution	Max. Frame Rate (fps)	Max. Bit Rate (Mbps)	Audio codec	USB	Media server	CE-HTML	HTML5	YouTube
.as .m2a .m2a	AVCHD	MVC	1920x1080 @ field rate = 50, 60Hz 1920x1080p @ frame rate = 24, 25, 30Hz 1280x720 @ frame rate = 50, 60Hz	-	30	MPEG-1 (L1&L2), MPEG-1,2,2.5 L3, AAC/HE-AAC (V1&V2), Dolby Digital, Dolby Digital Plus, Dolby Pulse	Yes	Yes	No	No	No
.m4v	M4V	H.264	1920x1088	25p, 30p, 50p, 60p, 60i	30	AAC	Yes	Yes	Yes	Yes	No
.im/PhotoCast .mp4	frag MP4	H.264	1920x1088	25p, 30p, 50p, 60p, 60i	30	AAC/HE-AAC (V1&V2), Dolby Digital, Dolby Digital Plus, WMA, WMA-PRO	No	No	Yes	Yes	Yes
		MVC	1920x1080 @ field rate = 50, 60Hz 1920x1080p @ frame rate = 24, 25, 30Hz 1280x720p @ frame rate = 50, 60Hz	-	30		No	No	Yes	Yes	Yes

Supported audio/video formats

File Extensions	Container	Video codec	Maximum resolution	Max. Frame Rate (fps)	Max. Bit Rate (Mbps)	Audio codec	USB	Media server	CE-HTML	HTML5	YouTube
.mp4	MP4	MPEG-4 ASP	1920x1088	25p, 30p, 50i, 60i	30	AAC/HE-AAC (V1&V2), Dolby Digital, Dolby Digital Plus, WMA, WMA-PRO	Yes	Yes	Yes	Yes	Yes
		H.264	1920x1088		30		Yes	Yes	Yes	Yes	No
		MVC	1920x1080 @ field rate = 50, 60Hz 1920x1080p @ frame rate = 24, 25, 30Hz 1280x720p @ frame rate = 50, 60Hz	-	30		Yes	Yes	Yes	Yes	No
		WHV9/VC1	1920x1088	30p, 60i	30		Yes	Yes	Yes	Yes	No
.m4v .m4sd	MKV	MPEG-4 ASP	1920x1088	25p, 30p, 50i, 60i	30	MPEG-1 (L1&L2), MPEG-1,2,2.5 L3, AAC/HE-AAC (V1&V2), Dolby Digital, Dolby Digital Plus, WMA, WMA-PRO	Yes	Yes	No	No	No
		H.264	1920x1088		30		Yes	Yes	No	No	No

Supported audio/video formats

File Extensions	Container	Video codec	Maximum resolution	Max. Frame Rate (fps)	Max. Bit Rate (Mbps)	Audio codec	USB	Media server	CE-HTML	HTML5	YouTube
.asf .wmv	ASF	MPEG-2	1920x1088	25p, 30p, 50i, 60i	20	MPEG-1 (L1&L2), MPEG-1,2,2.5 L3, AAC/HE-AAC (V1&V2), Dolby Digital Plus, Dolby Digital, WMA, WMA-PRO	Yes	Yes	Yes	Yes	No
		MPEG-4 ASP	1920x1088	25p, 30p, 50i, 60i	20		Yes	Yes	Yes	Yes	No
		WHV9/VC1	1920x1088	30p, 60i	20		Yes	Yes	Yes	Yes	No
.asf .wmv	AVI	MPEG-4 ASP	1920x1088	25p, 30p, 50i, 60i	4	MPEG-1 (L1&L2), MPEG-1,2,2.5 L3, AAC/HE-AAC (V1&V2), Dolby Digital Plus, Dolby Digital, WMA, WMA-PRO	Yes	Yes	No	No	No
		DhX 3.11	1920x1088	30p, 60i	4		Yes	Yes	No	No	No
.webm	WebM	VP8	1920x1088		5	Ogg Vorbis	Yes	Yes	Yes	Yes	No
.swf	SWF	Contains FLV	-	-	30	-	No	No	No	No	Yes
.divx	DMF (DIVX)	MPEG-4 ASP	1920x1088	25p, 30p, 50i, 60i	20	MPEG-1 (L1&L2), MPEG-1,2,2.5 L3, AAC/HE-AAC (V1&V2), Dolby Digital Plus, Dolby Digital, WMA, WMA-PRO	Yes	No	No	No	No
		DhX 3.11	1920x1088	30p, 60i	20		Yes	No	No	No	No

Supported audio/video formats

File Extensions	Container	Video codec	Maximum resolution	Max. Frame Rate (fps)	Max. Bit Rate (Mbps)	Audio codec	USB	Media server	CE-HTML	HTML5	YouTube
.3gp .3g2	3GP	MPEG-4 ASP	1920x1088	25p, 30p, 50i, 60i	30	AAC/HE-AAC (V1&V2), AMR	Yes	Yes	No	No	No
		H.264	1920x1088	25p, 30p, 50p, 60p, 60i	30		Yes	Yes	No	No	No
		H.263	1920 x 1088	30p	30		Yes	Yes	No	No	No
.mov .qt	QuickTime	-	-	-	30	-	Yes	Yes	No	No	No

Supported audio formats

File Extensions	Container	Video codec	Maximum resolution	Frequency (kHz)	Max. Bit Rate (Mbps)	Audio codec	USB	Media server	CE-HTML	HTML5	YouTube
.mp3	MP3	-	-	48	384	MPEG-1,2,2.5 L3	Yes	Yes	Yes	Yes	No
.wma .asf	WMA (V2 up to V9.2)	-	-	48	192	WMA	Yes	Yes	Yes	Yes	No
.wma	WMA Pro	-	-	96	768	WMA, WMA Pro	Yes	Yes	Yes	Yes	No
.lpcm (PC) .pcm (PC)	LPCM	-	-	192	768	LPCM	No	Yes	No	No	No
.wav (PC)	LPCM	-	-	192	768	LPCM	Yes	Yes	No	No	No
.aif (mac) .aiff (mac)	LPCM	-	-	192	768	LPCM	Yes	Yes	No	No	No
.aac .mp4 .m4a	AAC	-	-	48	1024	AAC, HE-AAC (v1&v2)	Yes	Yes	Yes	Yes	No
.pls .m3u	Playlists	-	-	-	-	-	Yes	Yes	No	No	No
.m4a	M4A	-	-	48	1024	AAC, HE-AAC (v1&v2)	Yes	Yes	Yes	Yes	No

Supported audio formats

File Extensions	Container	Video codec	Maximum resolution	Frequency (kHz)	Max. Bit Rate (Mbps)	Audio codec	USB	Media server	CE-HTML	HTML5	YouTube
.amr	AMR-NB (Smart TV only)	-	-	8 16	12.8 6.6 8.85 12.65 14.25 15.85 18.25 19.85	AMR	Yes	Yes	No	No	No
.ogg .oga	Ogg	-	-	48	498	Ogg Vorbis	Yes	Yes	No	No	No

Supported subtitle formats

Format	File Extension	USB	Media Server	CE-HTML	HTML5	YouTube
SRT	.srt	Yes	No	No	No	No
HVC/SRT	-	Yes	Yes	No	No	No
SUB	.sub	Yes	No	No	No	No
TEXT	.txt	Yes	Yes	No	No	No
Substation alpha V4	.ssa	Yes	Yes	No	No	No
Advanced substation alpha V4+	.ass	Yes	Yes	No	No	No
DVB	-	Yes	Yes	No	No	No
SAMI	.smi .sami	Yes	No	Yes	Yes	No
XSUB, XSUB+	.xsi .xsub	Yes	No	No	No	No
TTML	.ttml	No	No	Yes	Yes	No

Character encoding

- Windows-1250 (CP-1250): Central Europe and Eastern Europe Latin (Czech, Hungarian, Polish, Slovak, Slovenian, Croatian, Romanian, Serbian)
- Windows-1251 (CP-1251): Cyrillic
- Windows-1252 (CP-1252): Western Europe Latin
- Windows-1253 (CP-1253): Greek
- Windows-1254 (CP-1254): Turkish
- UTF-8: Multi-byte character encoding for Unicode

Connectivity

Rear

- HDMI 1 ARC: HDMI Audio Return Channel
- For PFL43x8: HDMI 2
- AUDIO IN (DVI): stereo 3.5 mm mini-jack
- NETWORK: Ethernet LAN RJ-45 (for certain models)
- SERV. U: Service port
- CVBS/Y, Pb, Pr, Audio L/R: Composite video and audio

- DIGITAL AUDIO OUT: Coaxial
- TV ANTENNA: 75 ohm coaxial (IEC)
- SCART (RGB/CVBS): SCART adaptor
- SAT: F-pin satellite (for certain models)

Side

- CI: Common Interface
- HDMI
- USB
- Headphones: stereo 3.5mm mini-jack

Help version

UMv 300812125204

8 Index

3

- 3D - 16
 - 3D glasses, care - 5
 - 3D, 2D to 3D - 17
 - 3D, change format - 17
 - 3D, health warning - 4
 - 3D, start - 17
 - 3D, switch off - 17
-

A

- amplifier, select output - 48
 - analogue channels, fine-tune - 30
 - analogue channels, install - 30
 - analogue channels, subtitles - 33
 - audio language - 33
 - auto subtitle shift - 48
 - Auto switch off, devices - 47
-

C

- cables - 37
- CAM - 49
- CAM, enable - 49
- CAM, insert - 49
- channel list - 14
- channel list, copy - 31
- channels - 13
- channels, favourites - 13
- channels, fine-tune (analogue) - 30
- channels, hide or unhide - 14
- channels, install (analogue) - 30
- channels, install (automatic) - 30
- channels, install (digital) - 30
- channels, install (satellite) - 32
- channels, logo - 14
- channels, reinstall - 36

- channels, rename - 14
 - channels, sort - 14
 - channels, switch - 13
 - channels, update - 31
 - child lock - 26
 - CI - 49
 - clock - 26
 - codecs, supported - 55
 - Common Interface - 49
 - Conditional Access Module - 49
 - connect, computer - 45
 - connect, digital camcorder - 44
 - connect, digital camera - 43
 - connect, disc player - 38
 - connect, external hard disk - 44
 - connect, game console - 41
 - connect, home theatre - 42
 - connect, recorder - 40
 - connect, TV receiver - 39
 - connect, USB device - 44
 - connected device, rename - 46
 - connectivity - 58
 - connectivity guide - 9
 - connectors - 37
 - contact Philips - 9
 - controls - 10
-

D

- demo - 35
- devices, watch - 46
- digital camcorder - 44
- digital camera - 43
- digital channels, install - 30
- digital channels, subtitles - 34
- digital radio - 14
- disc player, connect - 38
- display resolutions - 54

display specifications - 54

DivX VOD - 19

E

EasyLink - 46

EasyLink, controls - 47

EasyLink, enable - 47

EasyLink, features - 46

EasyLink, onscreen control - 12

EasyLink, remote control - 47

EasyLink, TV speakers - 48

Energy label - 9

energy-efficient settings - 8

EPG, broadcaster - 16

external hard disk - 44

F

favourite channels, list - 13

G

game console, connect - 41

game settings - 24

games, two player - 24

H

HDMI - 37

HDMI ARC - 37

hearing-impaired access - 34

help, onscreen - 9

Help, version - 58

home mode - 35

home theatre, connect - 42

I

install channels, automatic - 30

K

Kensington lock - 5

key beep - 34

L

language, menu - 33

language, subtitles - 34

lock TV - 5

M

mode, home or shop - 35

multimedia, play files - 17

multimedia, play options - 18

multimedia, supported formats - 55

O

online forum - 9

P

parental rating - 27

pause TV - 20

pause TV, USB hard drive - 20

PC, display resolutions - 54

picture format - 15

picture settings - 28

picture settings, reset - 29

Pixel Plus link - 48

placement, stand or wall - 5

placement, tips - 5

play, USB files - 17

power specifications - 54

presets, picture and sound - 15

product support - 9

programme guide, broadcaster - 16

R

rear controls - 10

record TV, one-touch - 22

record TV, USB hard drive - 21

record, TV programmes - 21

recorder, connect - 40
 recordings, delete - 23
 recordings, schedule - 22
 recordings, watch - 23
 recycle - 8
 reinstall - 36
 remote control - 11
 rename channels - 14
 rename, connected device - 46

S

safety - 3
 satellite, add or remove - 33
 satellite, install channels - 32
 satellite, settings - 32
 SCART - 37
 schedule, recordings - 22
 screen care - 5
 sensors - 10
 settings assistant - 28
 settings, audio format - 29
 settings, game - 24
 settings, picture - 28
 settings, sound - 29
 shop mode - 35
 sleep timer - 26
 software, check version - 35
 software, digital update - 36
 software, USB update - 35
 sound settings - 29
 sound settings, reset - 29
 sound specifications - 54
 source, select - 15
 standby - 12
 standby LED - 10
 subtitles, analog - 33
 subtitles, digital - 34

subtitles, language - 34
 sustainability - 8
 switch TV on, off - 12

T

teletext, search - 25
 text 2.5 - 25
 text, digital text - 25
 text, dual screen - 25
 text, enlarge - 25
 text, language - 25
 text, subpages - 25
 text, Table Of Pages - 25
 trademarks and copyrights - 7
 TV controls - 10
 TV guide, broadcaster - 16
 TV receiver, connect - 39
 TV speakers, mute - 13

U

universal access, enable - 34
 universal access, hearing impaired - 34
 universal access, visually impaired - 34
 USB, play files - 17

V

visually impaired access - 34
 volume - 13

Y

YPbPr, component video - 37

