

Register your product and get support at

[www.philips.com/welcome](http://www.philips.com/welcome)

PFL42x8

PFL32x8

---

EN User Manual

**PHILIPS**

# Contents

<b>1</b>	<b>Important</b>	<b>3</b>	<b>6</b>	<b>Troubleshooting</b>	<b>62</b>
	Safety	3		General issues	62
	Care	4		Channel issues	63
	Legal	5		Picture issues	63
	Sustainability	7		Sound issues	64
	Help and support	9		Connection issues	64
<b>2</b>	<b>Use your TV</b>	<b>10</b>		Network issues	65
	TV controls	10		Contact Philips	65
	Watch TV	12	<b>7</b>	<b>Specifications</b>	<b>66</b>
	View programme guide	16		Power and reception	66
	Play multimedia files	17		Display and sound	66
	Smart TV	20		Display resolutions	66
	Interactive TV	22		Multimedia	67
<b>3</b>	<b>Use more of your TV</b>	<b>23</b>		Connectivity	69
	Pause TV	23		Help version	69
	Record TV shows	24	<b>8</b>	<b>Index</b>	<b>70</b>
	Use Skype™	27			
	Play games	30			
	View Text	31			
	Set locks and timers	32			
<b>4</b>	<b>Change your TV settings</b>	<b>34</b>			
	Picture and sound	34			
	Channels	36			
	Satellite settings	39			
	Language settings	40			
	Universal access settings	41			
	Other settings	42			
	Update software	42			
	Reset all	43			
<b>5</b>	<b>Connect your TV</b>	<b>44</b>			
	About cables	44			
	Connect antenna	45			
	Connect devices	45			
	Connect more devices	52			
	Watch connected devices	54			
	Set up EasyLink devices	54			
	Connect to a network and the Internet	57			
	Connect a CAM (Conditional Access Module)	61			

# 1 Important

## Safety

### Precautions

Read and understand all instructions before you use your TV. If damage is caused by failure to follow the instructions, the warranty does not apply.

#### Risk of electric shock or fire!

- Never expose the TV to rain or water. Never place liquid containers, such as vases, near the TV. If liquids are spilled on or into the TV, disconnect the TV from the power outlet immediately. Contact Philips Consumer Care to have the TV checked before use.
- Never place the TV, remote control or batteries near naked flames or other heat sources, including direct sunlight. To prevent the spread of fire, keep candles or other flames away from the TV, remote control and batteries at all times.



- Never insert objects into the ventilation slots or other openings on the TV.
- Never expose the remote control or batteries to rain, water or excessive heat.
- Avoid force coming onto power plugs. Ensure that the power plug is fully inserted into the power socket. Loose power plugs can cause arcing or fire.

- When the TV is swivelled, ensure that no strain is exerted on the power cord. Strain on the power cord can loosen connections and cause arcing.
- To disconnect the TV from the mains power, the power plug of the TV must be disconnected. When disconnecting the power, always pull the power plug, never the cord. Ensure that you have full access to the power plug, power cord and outlet socket at all times.

#### Risk of damage to the TV!

- Two people are required to lift and carry a TV that weighs more than 25kg or 55lbs.
- When stand mounting the TV, use only the supplied stand. Secure the stand to the TV tightly. Place the TV on a flat, level surface that can support the combined weight of the TV and the stand.
- When wall mounting the TV, use only a wall mount that can support the weight of the TV. Secure the wall mount to a wall that can support the combined weight of the TV and wall mount. TP Vision Netherlands B.V. bears no responsibility for improper wall mounting that result in accident, injury or damage.
- If you need to store the TV, disassemble the stand from the TV. Never lay the TV on its back with the stand installed.
- Before you connect the TV to the power outlet, ensure that the power voltage matches the value printed on the back of the TV. Never connect the TV to the power outlet if the voltage is different.
- Parts of this product may be made of glass. Handle with care to avoid injury and damage.

### **Risk of injury to children!**

Follow these precautions to prevent the TV from toppling over and causing injury to children:

- Never place the TV on a surface covered by a cloth or other material that can be pulled away.
- Ensure that no part of the TV hangs over the edge of the surface.
- Never place the TV on tall furniture, such as a bookcase, without anchoring both the furniture and TV to the wall or a suitable support.
- Educate children about the dangers of climbing on furniture to reach the TV.

### **Risk of swallowing batteries!**

- The product/remote control may contain a coin-type battery, which can be swallowed. Keep the battery out of reach of children at all times!

### **Risk of overheating!**

- Never install the TV in a confined space. Always leave a space of at least 4 inches or 10 cm around the TV for ventilation. Ensure that curtains or other objects never cover the ventilation slots on the TV.

### **Risk of injury, fire or power cord damage!**

- Never place the TV or any objects on the power cord.
- Disconnect the TV from the socket and aerial before lightning storms. During lightning storms, never touch any part of the TV, power cord or aerial cable.

### **Risk of hearing damage!**

- Avoid using earphones or headphones at high volumes or for prolonged periods of time.

### **Low temperatures**

- If the TV is transported in temperatures below 5°C or 41°F, unpack the TV and wait until the TV temperature matches room temperature before connecting the TV to the power outlet.

---

## Care

---

### Screen

- Risk of damage to the TV screen! Never touch, push, rub or strike the screen with any object.
- Unplug the TV before cleaning.
- Clean the TV and frame with a soft damp cloth and wipe gently. Never use substances such as alcohol, chemicals or household cleaners on the TV.
- To avoid deformations and colour fading, wipe off water drops as soon as possible.
- Avoid stationary images as much as possible. Stationary images are images that remain onscreen for extended periods of time. Stationary images include onscreen menus, black bars, time displays, etc. If you must use stationary images, reduce screen contrast and brightness to avoid screen damage.

---

### Placement tips

- Position the TV where light does not shine directly on the screen.
- The ideal viewing distance of this TV is three times its diagonal screen size. For example, if the diagonal screen size of the TV is 81 cm / 32", the ideal viewing distance is ~2.5 m / ~92" from the front of the screen.
- While seated, your eyes should be level with the centre of the screen.

### TV placement

You can apply the best sound settings for your TV by selecting the TV placement (wall mount or stand mount).

1. Press **Home**.
2. Select **[Setup]**, then press **OK**.
3. Select **[TV settings] > [General settings]** or **[TV placement]**.
4. Select **[On a TV stand]** or **[Wall mounted]**, then press **OK**.

---

## Lock the TV

Your TV is equipped with a Kensington security slot at the base of the TV. To secure the TV, purchase a Kensington anti-theft lock (sold separately).

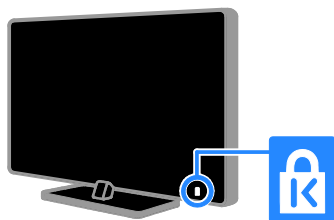

---

## Legal

---

### Notice

2013 © TP Vision Netherlands B.V. All rights reserved. Specifications are subject to change without notice. Trademarks are the property of Koninklijke Philips Electronics N.V or their respective owners. TP Vision Netherlands B.V. reserves the right to change products at any time without being obliged to adjust earlier supplies accordingly.

The material in this manual is believed adequate for the intended use of the system. If the product, or its individual modules or procedures, are used for purposes other than those specified herein, confirmation of their validity and suitability must be obtained. TP Vision Netherlands B.V. warrants that the material itself does not infringe any United States patents. No further warranty is expressed or implied.

TP Vision Netherlands B.V. cannot be held responsible neither for any errors in the content of this document nor for any problems as a result of the content in this document. Errors reported to Philips will be adapted and published on the Philips support website as soon as possible.

### Terms of warranty

- Risk of injury, damage to TV or void of warranty! Never attempt to repair the TV yourself.
- Use the TV and accessories only as intended by the manufacturer.
- The caution sign printed on the back of the TV indicates risk of electric shock. Never remove the TV cover. Always contact Philips Customer Care for service or repairs.
- Any operation expressly prohibited in this manual, or any adjustments and assembly procedures not recommended or authorised in this manual, shall void the warranty.

### Pixel characteristics

This LCD/LED product has a high number of colour pixels. Although it has effective pixels of 99.999% or more, black dots or bright points of light (red, green or blue) may appear constantly on the screen. This is a structural property of the display (within common industry standards) and is not a malfunction.

### CE compliance

This product is in compliance with the essential requirements and other relevant provisions of Directives 2006/95/EC (Low Voltage), 2004/108/EC (EMC) and 2011/65/EU (ROHS).



## Compliance with EMF

TP Vision Netherlands B.V. manufactures and sells many products targeted at consumers which, like any electronic apparatus, in general have the ability to emit and receive electromagnetic signals.

One of Philips' leading Business Principles is to take all necessary health and safety measures for our products, to comply with all applicable legal requirements and to stay well within the Electro Magnetic Field (EMF) standards applicable at the time of producing the products.

Philips is committed to develop, produce and market products that cause no adverse health effects. TP Vision confirms that, as long as its products are handled properly for their intended use, they are safe to use according to scientific evidence available today.

Philips plays an active role in the development of international EMF and safety standards, enabling Philips to anticipate further developments in standardisation for early integration in its products.

---

## Open source

This product contains software licensed under an open-source licence. For acknowledgments and licence texts, please refer to the electronic in-product user manual. TP Vision Netherlands B.V. hereby offers to deliver, upon request, a copy of the complete corresponding source code for the copyrighted open source software packages used in this product for which such offer is requested by the respective licences.

This offer is valid up to three years after product purchase to anyone in receipt of this information. To obtain source code, please send your request in English with product number to:

"Intellectual Property Department, TP Vision Netherlands B.V., P.O. Box 80077, 5600 KA Eindhoven, The Netherlands".

---

## Trademarks and copyrights

Windows Media is either a registered trademark or trademark of Microsoft Corporation in the United States and/or other countries.



Manufactured under licence from Dolby Laboratories. Dolby and the double D symbol are trademarks of Dolby Laboratories.



The terms HDMI and HDMI High-Definition Multimedia Interface and the HDMI Logo are trademarks or registered trademarks of HDMI Licensing LLC in the United States and other countries.



Kensington and Micro Saver are registered US trademarks of ACCO World Corporation with issued registrations and pending applications in other countries throughout the world.



DLNA®, the DLNA Logo and DLNA CERTIFIED® are trademarks, service marks or certification marks of the Digital Living Network Alliance.



Covered by one or more of the following U.S. patents: 7,295,673; 7,460,668; 7,515,710; 7,519,274.

DivX®, DivX Certified® and associated logos are trademarks of Rovi Corporation or its subsidiaries and are used under licence.

DivX Certified® to play DivX® video up to HD 1080p, including premium content.

**ABOUT DIVX VIDEO:** DivX® is a digital video format created by DivX, LLC, a subsidiary of Rovi Corporation. This is an official DivX Certified® device that plays DivX video. Visit [divx.com](http://divx.com) for more information and software tools to convert your files into DivX videos.

**ABOUT DIVX VIDEO-ON-DEMAND:** This DivX Certified® device must be registered in order to play purchased DivX Video-on-Demand (VOD) movies. To obtain your registration code, locate the DivX VOD section in your device setup menu. Go to [vod.divx.com](http://vod.divx.com) for more information on how to complete your registration.



Skype is a trademark of Skype Limited or its related companies.

### PlayReady Final Products

Content owners use Microsoft PlayReady™ content access technology to protect their intellectual property, including copyrighted content. This device uses PlayReady technology to access PlayReady protected content and/or WMDRM-protected content. If the device fails to properly enforce restrictions on content usage, content owners may require Microsoft to revoke the device's ability to consume PlayReady-protected content. Revocation should not affect unprotected content or content protected by other content access technologies. Content owners may require you to upgrade PlayReady to access their content. If you decline an upgrade, you will not be able to access content that requires the upgrade.

All other registered and unregistered trademarks are the property of their respective owners.

## Sustainability

### Energy efficiency

This TV is designed with energy-efficient features. To access these features, press the **Green button** on the remote control.

- **Energy saving picture settings:** You can apply a combination of energy saving picture settings. While you watch TV, press the **Green button** and select **[Energy saving]**. Then select the **[Energy saving]** picture setting.
- **Screen off:** If you only want to listen to audio from the TV, you can switch off the TV display. Other functions continue to operate normally. While you watch TV, press the **Green button** and select **[Screen off]**.
- **Low standby power:** The advanced power circuitry reduces the power consumption of the TV to an extremely low level, without losing the constant standby functionality.
- **Auto switch off:** To conserve energy, set the TV to switch off automatically after a period of inactivity. While you watch TV, press the **Green button** and select **[Auto switch off]**. Then select the period after which the TV switches off.
- **Switch off inactive devices:** Switch off connected EasyLink HDMI-CEC (Consumer Electronic Control) compliant devices that are inactive. While you watch TV, press the **Green button** and select **[Inactive devices off]**.
- **Power management:** An advanced power management helps save the energy consumed by this TV. To view how your personalised TV settings affect the TV's relative power consumption, press **⬆**, then select **[Setup] > [Watch demos] > [Active Control demo]**.

- **Power management:** An advanced power management helps save the energy consumed by this TV. To view how your personalised TV settings affect the TV's relative power consumption, press **⬆**, then select **[Setup] > [Watch demos] > [Active Control demo]**.

---

## Recycling

Your product is designed and manufactured with high quality materials and components, which can be recycled and reused.



When this crossed-out wheeled bin symbol is attached to a product it means that the product is covered by the European Directive 2002/96/EC. Please inform yourself about the local separate collection system for electrical and electronic products.



Please act according to your local rules and do not dispose of your old products with your normal household waste. Correct disposal of your old product helps to prevent potential negative consequences for the environment and human health.

Your product contains batteries covered by the European Directive 2006/66/EC, which cannot be disposed of with normal household waste. Please inform yourself about the local rules on separate collection of batteries because correct disposal helps to prevent negative consequences for the environment and human health.



---

## Energy label

The European Energy Label informs you on the energy efficiency class of the product. The greener the energy efficiency class of this product is, the lower the energy it consumes.

On the label, you can find the energy efficiency class, the average power consumption of the product in use and the average energy consumption for 1 year. You can also find the power consumption values for the product on the Philips website for your country at [www.philips.com/TV](http://www.philips.com/TV).



---

# Help and support

---

## Use Help

To access the onscreen **[Help]** menu, press the **Blue button**.

To exit from the **[Help]** menu, press **⬆**.

---

## Visit the Philips website

If you can't find what you need in the onscreen **[Help]**, visit the Philips support website at [www.philips.com/support](http://www.philips.com/support).

On the Philips support website, you can also:

- Find answers to Frequently Asked Questions (FAQ)
- Download a printable PDF version of this user manual
- Email us a specific question
- Chat online with Philips Consumer Care (available in certain countries only)

---

## Use the Philips connectivity guide

An easy-to-use connectivity guide gives you guidance on how to connect your TV to other devices. Visit

<http://www.connectivityguide.philips.com>.

---

## Search the TV forum

Your question may have already been answered by the Philips TV community of users. Visit [www.supportforum.philips.com](http://www.supportforum.philips.com).

---

## Contact Philips

You can contact Philips Consumer Care in your country for support. The number is available in the leaflet accompanying this product or online at [www.philips.com/support](http://www.philips.com/support).

Before you contact Philips, write down the model and serial number of your TV. You can find this information on the back of your TV or on the TV packaging.

## 2 Use your TV

### TV controls

#### Rear controls

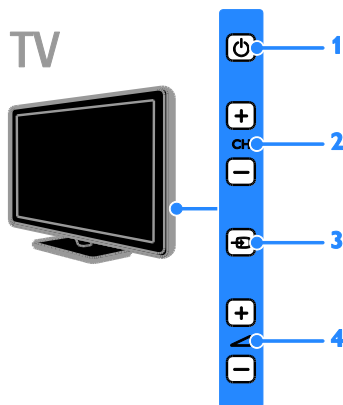

1. **⏻ (Standby):** Switch the TV on or off.
2. **CH +/-:** Switch to the next or previous channel.
3. **⏮ (SOURCE):** Watch a connected device.
4. **🔊 +/- (Volume):** Increase or decrease volume.

### Sensors and indicators

#### TV

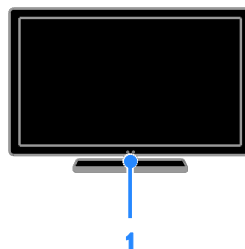

#### For PFL4xx8

##### 1. Remote control sensor

Point the remote control at the sensor.  
Make sure that the line of sight between the remote control and the TV is not blocked.

#### TV

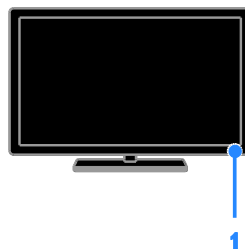

#### For PFL3xx8

##### 1. Remote control sensor

Point the remote control at the sensor.  
Make sure that the line of sight between the remote control and the TV is not blocked.

## Remote control

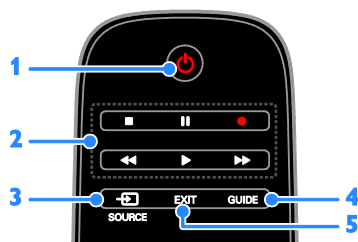

1. **⏻ (Standby):** Switch the TV on or to standby.
2. **Play buttons:** Control playback of multimedia files.
3. **SOURCE:** Watch a connected device.
4. **GUIDE:** View programme guide.
5. **EXIT:** Exit from menus or TV functions.

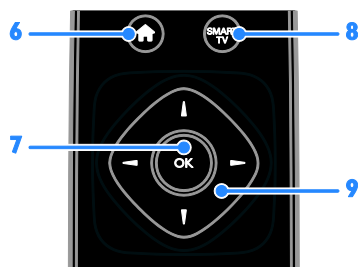

6. **🏠 (Home):** Access the Home menu.
7. **OK:** Confirm an entry or selection.
8. **SMART TV:** Access Smart TV.
9. **▲▼◀▶ (Navigation buttons):** Navigate through menus and select items.

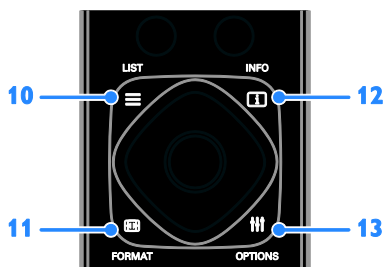

10. **☰ LIST:** Access the TV channel list.
11. **FORMAT:** Change the picture format to suit the video source.
12. **INFO:** Display information about current activity.
13. **≡ OPTIONS:** Access currently available options, picture and sound menus.

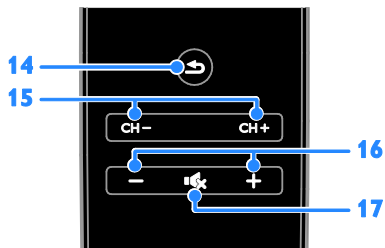

14. **↶ (Back):** Return to the previous menu page or exit from a TV function.
15. **CH +/-:** Switch channels.
16. **+/- (Volume):** Adjust volume.
17. **🔇 (Mute):** Mute or restore audio.

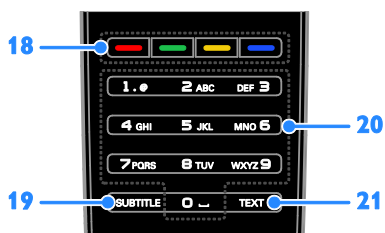

18. **Colour buttons:** Select tasks or options. The buttons function according to the services offered by the service provider.
19. **SUBTITLE:** Switch on or off subtitles.
20. **0-9 (Numeric buttons):** Select TV channels or enter text.
21. **TEXT:** Enable or disable text.

## EasyLink controls

If you connect your TV to HDMI-CEC enabled devices, such as a Blu-ray player or home theatre, you can control them at the same time with one remote control. Simply switch on EasyLink after connection.

Read more about Easylink in **Connect your TV > Set up Easylink devices > Control devices** (Page 55).

---

## On-screen remote control

You can also control connected HDMI-CEC enabled devices through other buttons that are available through the on-screen remote control. Make sure that Easylink is switched on after connection. Read more about Easylink in **Connect your TV > Set up Easylink devices > Control devices** (Page 55).

### To access the on-screen remote control

1. While you watch a connected device, press **III** **OPTIONS**.
2. Select **[Show remote control]**, then press **OK**.
3. Select an on-screen button, then press **OK**.

---

## Smartphone control

With the smartphone application 'Philips MyRemote', you can use your smartphone as a secondary remote and even as a keyboard. You can also watch a slideshow of the images in your smartphone on the TV.

**Note:** Make sure that your TV and smartphone are connected to the same local network. For more information, see **Connect your TV > Connect to a network and the Internet** (Page 57).

Follow these instructions to download the application 'Philips MyRemote':

1. Visit the Apple App store or Google Play to download the application 'Philips MyRemote' on your smartphone.
2. Follow the instructions provided at the applications store.

---

## Watch TV

---

### Switch TV on or off

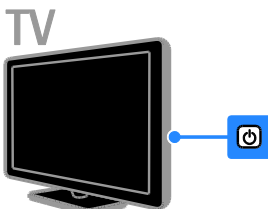
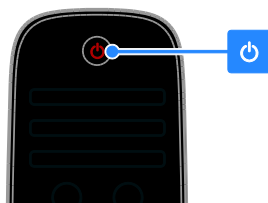

### Switch the TV on

- Connect the TV to the mains outlet and switch on the main power.
- If the TV is not switched on, the standby LED remains off. Press **⏻** on the TV.
- If the standby LED is lit, press **⏻** on the remote control.

**Note:** There is a short delay before the TV responds.

**Tip:** If you cannot find your remote control and want to switch on the TV from standby, press any button the TV.

### Switch TV to standby

Press **⏻** on the remote control. The standby LED on the TV switches to red.

### Switch off the TV

Press **⏻** on the TV. The standby LED switches to off.

**Note:** Though your TV consumes very little energy when it is in standby or switched off, it does use some energy. If you are not going to use the TV for an extended period of time, disconnect the TV from the mains plug.

## Automatic switch off

You can save energy with this TV's energy efficiency settings, which are enabled by default. If there is no user interaction (such as pressing a remote control button or a control on the TV) for four hours, the TV will automatically switch to standby.

### To disable automatic switch off

1. While you watch TV, press the **Green button** on the remote control.
2. Select **[Auto switch off]**, then press **OK**.
3. Select **[Off]**, then press **OK**.

## Adjust TV volume

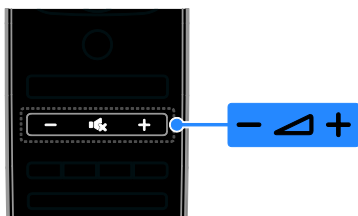

TV



### Increase or decrease the TV volume

- Press **+/-** on the remote control.
- Press **▲ +/-** on the TV.

### Mute or restore the TV volume

- Press **🔇** on the remote control to mute the volume.
- Press **🔇** again to restore the volume.

### Adjust headphone volume

1. Press **🏠**.
2. Select **[Setup] > [TV settings] > [Sound] > [Headphone volume]**, then press **OK**.
3. Select a level.

## Switch TV channels

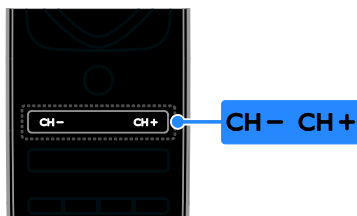

TV



- Press **CH +/-** on the remote control or TV.
- Press the **Numeric buttons** on the remote control to enter a channel number.

## Manage favourite channels

You can view all channels or only a list of your favourite channels.

### Create a list of your favourite channels

1. Press **≡ LIST**.
2. Select the channel to mark as favourite, then press **≡ OPTIONS**.
3. Select **[Add/remove favourites]**, then press **OK**.

The selected channel is marked with an asterisk.

To remove a channel from the favourites list, select **[Add/remove favourites]**, then press **OK**.

### Display your list of favourite channels

1. Press **≡ LIST**, then press **≡ OPTIONS**.
2. Select **[List] > [Favourites]** to display channels in the favourite list.
3. Press **OK** to confirm.

---

## Manage channel lists

After the channels are installed, you can:

- Filter channels.
- Switch between antenna and cable channels.
- Rename channels.
- Reorder channels.
- Lock a channel.
- Listen to digital radio.

### Filter channels

1. While you watch TV, press **≡ LIST**.
2. Press **≡ OPTIONS**, then select **[Filter]**.
3. Select an option, then press **OK**.
  - **[Digital + Analogue]**: Display all channels in the channels list.
  - **[Digital TV channels]**: Display only digital channels.
  - **[Analogue Channels]**: Display only analogue channels.
  - **[Free / scrambled]**: Display all channels in the channels list.
  - **[Scrambled channels]**: Display only scrambled channels.
  - **[Free channels]**: Display only free channels.

**Note:** The filtering options may vary according to your broadcaster.

### Switch between antenna and cable channels

You can switch between antenna and cable channels while you are watching TV.

1. While you watch TV, press **🏠**.
2. Select **[Setup] > [Channel settings] > [Channel installation] > [Antenna connection]**.
3. Select **[Antenna (DVB-T)]** to watch antenna channels or **[Cable (DVB-C)]** to watch cable channels, then press **OK**.

### Rename channels

When you select a channel, its name appears. You can change this channel name.

1. While you watch TV, press **≡ LIST**. The channel list is displayed.
2. Select the channel to rename, then select **≡ OPTIONS**.

3. Select **[Rename]**, then press **OK**. The onscreen keyboard is displayed.
4. Press the **Navigation buttons** to select each character, then press **OK**.
5. Once complete, select **[Done]**, then press **OK** to confirm.

### Reorder channels

After the channels have been installed, you can reorder the channel list.

1. While you watch TV, press **≡ LIST**. The channel list is displayed.
2. Press **≡ OPTIONS**.
3. Select **[Reorder]**, then press **OK**.
4. Select the channel to reorder, then press **OK**.
5. Press the **Navigation buttons** to move the highlighted channel to another location, then press **OK**.
6. Once complete, press **≡ OPTIONS**.
7. Select **[Exit reorder]**, then press **OK**.

### Lock a channel

You can prevent unauthorised access to channels by locking them.

1. While you watch TV, press **≡ LIST**. The channel list is displayed.
2. Select the channel to lock, then press **≡ OPTIONS**.
3. Select **[Lock channel]**, then press **OK**.
4. If prompted, enter the PIN code. The channel is marked with a lock icon in the channel list.

**Tip:** To watch a locked channel, enter the PIN code when prompted.

### Listen to digital radio

If digital radio channels are available, you can listen to them. They are installed automatically when you install the TV channels.

1. While you watch TV, press **≡ LIST**. The channel list is displayed.
2. Press **≡ OPTIONS**.
3. Select **[Filter] > [Radio]**, then press **OK**.
4. Select a radio channel, then press **OK**.

---

## Watch connected devices

Before you can watch a device, connect the device to the TV. See **Connect your TV > Connect devices** (Page 45).

### Select a device with SOURCE

1. Press **⏏ SOURCE**.
2. Select a device, then press **OK**.

### Select a device from the Home menu

1. Press **🏠**.
2. Select **[Source]**, then press **OK**.
3. Select the device, then press **OK**.

To add or manage your connected devices, see **Connect your TV > Watch connected devices > Change device settings** (Page 54).

---

## Use picture and sound presets

Your TV comes with predefined picture and sound settings. You can apply these settings or customise them.

### Select your preferred picture settings

1. While you watch TV, press **⏏ OPTIONS**.
2. Select **[Picture and sound] > [Picture style]**, then press **OK**.
3. Select an option, then press **OK**:
  - **[Personal]**: Apply your personalised picture settings.
  - **[Vivid]**: Rich and dynamic settings, ideal for daytime viewing.
  - **[Natural]**: Natural picture settings.
  - **[Standard]**: Default settings that suit most environments and types of video.
  - **[Movie]**: Ideal settings for movies.
  - **[Photo]**: Ideal settings for photos.
  - **[Energy saving]**: Settings that conserve the most energy.

### Select your preferred sound settings

1. While you watch TV, press **⏏ OPTIONS**.
2. Select **[Picture and sound] > [Sound style]**, then press **OK**.
3. Select an option, then press **OK**:
  - **[Personal]**: Apply your personalised sound settings.
  - **[Original]**: Settings that suit most environments and types of audio.
  - **[Movie]**: Ideal settings for movies.
  - **[Music]**: Ideal settings for listening to music.
  - **[Game]**: Ideal settings for games.
  - **[News]**: Ideal settings for spoken audio, such as the news.

---

## Change picture format

You can change the picture format to suit the video source.

1. Press **⏏ FORMAT**.
2. Select a picture format, then press **OK**.

The available picture formats depend on the video source:

- **[Auto fill]**: Adjust the picture to fill the screen (subtitles remain visible). Recommended for minimal screen distortion but not for HD or PC.
- **[Auto zoom]**: Enlarge the picture to fill the screen. Recommended for minimal screen distortion but not for HD or PC.
- **[Super zoom]**: Remove the black bars on the sides of 4:3 broadcasts. Not recommended for HD or PC.
- **[Movie expand 16:9]**: Scale 4:3 format to 16:9. Not recommended for HD or PC.
- **[Wide screen]**: Shows widescreen format content unstretched. Not recommended for HD or PC.
- **[Unscaled]**: Provide maximum detail for PC. Only available when PC mode is selected in the Picture menu.
- **[4:3]**: Display the classic 4:3 format.

---

# View programme guide

---

## What you can do

You can view channel schedules and programme synopses for digital TV channels using programme guides provided by the broadcasters. The availability of programme guides is dependent on your broadcaster.

You can view programme guides through one of two methods:

- From the broadcaster
- From the Internet

You cannot view a channel's programme guide information if:

- the age rating of the channel is equal or higher than the age rating set on your TV.
- the channel is locked.

---

## From the broadcaster

### Select broadcaster programme guide

Before you use the programme guide, check the following settings:

1. Press **⬆**.
2. Select **[Setup] > [TV settings] > [General settings] > [TV guide]**.
3. Select **[From the broadcaster]**, then press **OK**.

### Access broadcaster programme guide

1. Press **⬆**.
2. Select **[TV guide]**, then press **OK**.
3. If you are viewing the programme guide for the first time, follow the onscreen instructions to update the guide.

### Customise broadcaster programme guide

You can customise the displayed information to:

- Remind you when programmes start.
- Display only preferred channels.
- Change day of display.
- Schedule recordings of programmes. See **Use more of your TV > Record TV shows > Schedule recordings** (Page 25).

**Note:** Options may vary according to the programme information available from the broadcaster.

1. In the programme guide, press **⏸** **OPTIONS**.

2. Select an option, then press **OK**:

- **[Update TV guide]:** Update programme guide information.
- **[Change day]:** Select the day to display programme guide.
- **[Search by genre]:** Search programmes by genre.
- **[All reminders]:** Display a list of all programme reminders.

---

## From the Internet

Make sure that your TV is connected to the Internet through a high-speed broadband connection. See **Connect your TV > Connect to a network and the Internet** (Page 57).

### Select Internet programme guide

Before you use the programme guide, check the following settings:

1. Press **⬆**.
2. Select **[Setup] > [TV settings] > [General settings] > [TV guide]**.
3. Select **[From the Internet]**, then press **OK**.

### Access Internet programme guide

1. Press **⬆**.
2. Select **[TV guide]**, then press **OK**.

**Note:** If you are viewing the programme guide for the first time, follow the onscreen instructions to update the guide.

### Customise Internet programme guide

You can use the programme guide to:

- Schedule recordings of programmes. See **Use more of your TV > Record TV shows > Schedule recordings** (Page 25).
- Identify channels.
- Select day of display.
- Reload and zoom into the programme guide information.
- View security information.



**Note:** Options may vary according to the programme information available from the broadcaster.

1. In the programme guide, press **⏏** **OPTIONS**.
2. Select an option, then press **OK**:
  - **[Record]**: Set a scheduled recording.
  - **[Identify channel]**: Manually update channel information.
  - **[Select day]**: Select the day to display.
  - **[Manual record]**: Set a scheduled recording.
  - **[Reload Page]**: Refresh the page display.
  - **[Zoom]**: Change zoom level of page display.
  - **[Security info]**: Display programme security information.

---

## Play multimedia files

---

### What you can do

You can play videos, photos and music on your TV from:

- Your computer connected through the home network.
- A USB device connected to the TV.

---

### Play files from computer

#### What you need

- A wired or wireless home network, connected with a Universal Plug and Play (uPnP) router.
- For wired networks: a LAN cable that connects your TV to your home network.
- For PFL32x8 wireless networks: A Philips wireless USB adapter PTA128 (sold separately)
- A media server running on your computer.
- Appropriate settings on your computer firewall to allow you to run the media server.

### Set up the network

1. Connect your TV and the computer to the same home network. See **Connect your TV > Connect to a network and the Internet** (Page 57).

2. Switch on your computer and the router.

#### Note:

If the apparatus does not return to DLNA mode due to external electrical disturbances (e.g. electrostatic discharge), user intervention is required.

### Set up media sharing

1. Install a media server on your computer to share media files. These are some media servers:

- **For PC:** Windows Media Player 11 (or higher) or TVersity
- **For Mac:** Twonky

2. Switch on media sharing on your computer using the media server. For more information on how to set up the media server, refer to the media server's website.

#### Play files

1. Press **⏏** **SOURCE**.
2. Select **[Browse network]**, then press **OK**.
3. Select a file from the content browser, then press **OK** to start play.
4. Press the **Play buttons** to control play.
5. Optional: To select a different media server, select **[Media server]**.

#### Tips:

- Select the top bar to filter your files by type.
- Select **[Sort]** to arrange the files by album name, artist or other fields.
- To clear the list of offline media servers, press **⏏** **OPTIONS**, then select **[Clear offline servers]** and press **OK**.

---

## Play files from USB device

If you have photos, videos or music files on a USB storage device, you can play the files on TV.

### Caution:

- TP Vision is not responsible if the USB hard drive is not supported, nor is it responsible for damage to or loss of data in the device.
- Do not overload the USB port. If you connect a USB storage device that consumes more than 500mA power, make sure that it is connected to its own external power supply.

### Browse USB device

1. Connect the USB device to the USB connector on the TV.
2. Press **⏏ SOURCE**, select **[USB]**, then press **OK**.
3. Select a file from the content browser, then press **OK** to start play.
4. Press the **Play buttons** to control play.
5. Optional: To select a different USB device, select **[USB device]** at the bottom of the TV screen.

### Tips:

- Select the top bar to filter your files by type.
- Select **[Sort]** to arrange the files by name, date or other fields.

---

## Play options

### Watch video

1. Select **■** in the top bar.
  2. Select a video, then press **OK**.
  3. Optional: To play all the videos in a folder, select a video, then select **[Play all]**.
- To skip to the next or previous video, press **CH+** or **CH-**.
  - To pause the video, press **OK**. Press **OK** again to resume playback.
  - To skip forward or backward 10 seconds, press **▶** or **◀**.
  - To search forward or backwards, press **▶▶** or **◀◀**. Press the button repeatedly to toggle between different speeds.
  - To stop the video, press **■**.

### Video options

While you play video, press **≡ OPTIONS**, then press **OK** to select an option:

- **[Subtitles]**: Select the available subtitle settings.
- **[Subtitle language]**: Select the language for subtitles if available.
- **[Character set]**: Select the correct character set for the subtitles.
- **[Audio language]**: Select an audio language.
- **[Repeat]**: Select **[Repeat]** to play the video file repeatedly or **[Play once]** to play the video file once.
- **[Media server]**: When you play content from a media server, you can select another media server.
- **[Shuffle on] / [Shuffle off]**: Enable or disable random play of video files.
- **[DivX® VOD]**: Display the DivX registration and deregistration codes for this TV.

### Note:

To view information about a video (for example, played position, duration, title or date), select the video, then press **ⓘ INFO**. To hide the information, press **ⓘ INFO** again.

### Listen to music

1. Select **🎵** in the top bar.
  2. Select a track, then press **OK**.
  3. Optional: To play all the tracks in a folder, select a track, then select **[Play all]**.
- To skip to the next or previous track, press **CH+** or **CH-**.
  - To pause the track, press **OK**. Press **OK** again to resume playback.
  - To skip forward or backward 10 seconds, press **▶** or **◀**.
  - To search forward or backwards, press **▶▶** or **◀◀**. Press repeatedly to toggle between different speeds.
  - To stop the music, press **■**.

## Music options

While you play music, press **III** **OPTIONS**, then press **OK** to select an option:

- **[Repeat]:** Select **[Repeat]** to play a track or an album repeatedly, or select **[Play once]** to play a track once.
- **[Media server]:** When you play content from a media server, you can select another media server.
- **[Shuffle on] / [Shuffle off]:** Enable or disable random play of tracks.

### Note:

To view information about a song (for example, title, artist or duration), select the song, then press **I** **INFO**.

To hide the information, press **I** **INFO** again.

## View photos

1. Select **🖼️** in the top bar.
2. Select a photo thumbnail, then press **OK**.

## Start a slideshow

If there are multiple photos in a folder, select a photo, then select **[Slideshow]**.

- To skip to the next or previous video, press **CH+** or **CH-**.
- To stop the slideshow or close the photo, press **≡** **LIST** or **■**.

## Slideshow options

While you play a slideshow, press **III** **OPTIONS**, then press **OK** to select an option:

- **[Shuffle off] / [Shuffle on]:** Enable or disable random display of pictures in the slideshow.
- **[Repeat]:** Select **[Repeat]** to watch a slideshow repeatedly or **[Play once]** to watch once.
- **[Slideshow time]:** Select the display time for each photo in the slideshow.
- **[Slideshow transitions]:** Select the transition from one photo to the next.
- **[Media server]:** When you play content from a media server, you can select another media server.

## Play DivX® VOD (Video On Demand)

This TV is DivX Certified(R) and plays high-quality DivX Video-On-Demand videos.

To play DivX VOD videos from a video store or from your computer, you must first activate DivX VOD on the TV. The DivX VOD activation of your TV is free of charge.

### Register the TV

If the TV is not yet activated when you start the playback of a rental DivX video, the TV displays the DivX registration code to activate this TV.

To register, follow these steps.

1. When the TV displays the 8 or 10-digit registration code, write down the code and go to <http://vod.divx.com>.
2. Download the DivX player software on your computer and install the software.
3. Start the DivX player software and create a DivX Account: Click VOD > Create a DivX Account.
4. In the DivX player, register the TV with the registration code of the TV: Click VOD > Register a DivX Certified Device.
5. When prompted, download and save the registration video to a USB flash drive or your connected media server.
6. Go to your TV and play the registration video on your TV. This completes the registration and activates DivX on your TV.

Consult the DivX website for detailed support.

### To de-register this TV:

1. Press **⏮** **SOURCE**.
2. Select **[Browse USB]**, then press **OK**.
3. Press **III** **OPTIONS**, select **[DivX® VOD]**, then press **OK**.
4. Follow the onscreen instructions.

---

# Smart TV

---

## What you can do

With Internet Applications (apps), which are specially adapted Internet websites for your TV, you can enjoy these features and more:

- Read newspaper headlines
- Watch and rent videos
- Check weather forecasts
- Catch up with TV programmes that you missed

Find out more about Smart TV services from the Smart TV forum website, [www.supportforum.philips.com](http://www.supportforum.philips.com).

### Note:

- Smart TV services and apps vary from country to country.
- Availability of catch-up TV apps and their TV programmes is subject to your TV's country setting. To find out which TV programmes are available, access the programme guide within the app.
- Smart TV displays one page at a time, in full-screen view.
- Certain websites may not display completely. Functions that require plug-ins may be unavailable.
- TP Vision Netherlands B.V. bears no responsibility regarding the content and the quality of the content provided by the content service providers.

---

## What you need

1. On your home network, connect the TV to the Internet.
2. On your TV, configure Smart TV.
3. Optional: On your PC, register with Philips to enjoy exclusive benefits and receive updates on product information. You can register at any time.

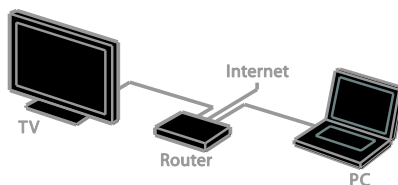

### Connect the TV to the Internet

1. On your home network, connect a router with a high-speed connection to the Internet.
2. Switch on the router.
3. Install the network. See **Connect the TV > Connect to a network and the Internet** (Page 57).

### Start Smart TV

1. Press **SMART TV**.

The terms and conditions of use are displayed.

2. Follow the onscreen instructions to complete registration.

**Note:** The first time you start Smart TV, a prompt asks if you want to enable parental control to lock adult apps. If you lock an adult app, advertisements and web pages that are not adapted for Smart TV will remain accessible.

---

## Access Smart TV apps

You can access apps through the Smart TV home page. The icons on this page represent the apps installed on your TV.

To access an app, select the app, then press **OK** to confirm.

### Add apps

1. Select **[App Gallery]**, then press **OK**.
2. Select an app, then press **OK** to add it to your home screen.
3. Follow the onscreen instructions to add the app.

### Tips:

- You can search for apps available in other countries.
- To return to the Smart TV home page, press **≡ LIST**.

**Note:** Smart TV services are updated automatically. To view the latest updates, in **[App Gallery]**, select **[All]**, then change to **[New]**.

### Access websites

1. Select an Internet app, then press **OK**.
2. Select the web address field, then press **OK**.

A keyboard appears on the screen.

3. For each character of the web address, select the character, then press **OK**.

**Tip:** You can also use the **Numeric buttons** on the TV remote control to enter a web address.

### Zoom page

To zoom in and out on an Internet page, do the following:

1. Press **≡ OPTIONS**, then select **[Zoom]**.
2. Use the slider bar to set the enlargement.
3. Use the **Navigation buttons** to jump between highlighted items and scroll through an Internet page.

### Scroll pages

Press the **Navigation buttons** **▲** and **▼** to scroll up and down on a web page.

### Reload page

If a page does not load correctly, press **≡ OPTIONS**, then select **[Reload Page]**.

### View security info

To view security information about a page, press **≡ OPTIONS**, then select **[Security info]**.

---

## Smart TV options

### Clear Smart TV memory

You can clear the Smart TV memory completely, including your favourites, parental control code, passwords, cookies and history.

**Warning:** This option resets the Smart TV memory completely. It also deletes the settings of other interactive applications such as DTVi (Digital TV interactive).

1. Press **▲**.
2. Select **[Setup] > [Network settings]**.
3. Select **[Clear Internet memory]**, then press **OK**.

---

## Rent online videos

### What you need

- Make sure that your TV is connected to the Internet through a high-speed broadband connection. See **Connect your TV > Connect to a network and the Internet** (Page 57).
- Connect a USB flash drive with a minimum capacity of 4 GB to the TV. For high-definition videos, use a flash drive with at least 8 GB of storage capacity.

**Note:** You can also use a single storage device to record, pause and rent videos. Connect a USB 2.0 compatible hard disk drive (HDD) with a minimum capacity of 250 GB and a minimum transfer speed of 30 megabits per second. Format the HDD before use (see **Use more of your TV > Pause TV > Install USB hard drive** (Page 23)).

## Format the USB flash drive

Before you download rented videos, your USB drive must be formatted. All existing content on the USB drive is erased.

1. Switch on the TV.
2. Connect the USB flash drive to a USB slot on the TV.
3. Press **III** to start formatting the drive.
4. After formatting, leave the USB drive connected to the TV.

## Access a video store

1. Press **SMART TV**.
2. Access the **[App Gallery]** to search for available video store apps in your country.
3. Select a store, then press **OK** to confirm. The icon of the video store is added to the home page.
4. To access a store, select its icon and press **OK**.

## Rent a video

Follow the onscreen instructions to rent, download and watch the video.

1. Open a video store app. You may need to register or enter your log-in information.
2. Select a video.
3. Make the online payment.
4. Download the video.
5. Start watching the video.

---

# Interactive TV

---

## What you can do

With interactive TV, you can view additional information or entertainment pages provided by digital TV broadcasters. You can experience true interactivity by responding directly to the digital content.

**Note:** You cannot download files to your TV with this feature.

Broadcasters use various interactive TV systems such as:

- HbbTV (Hybrid Broadcast Broadband TV)
- iTV (Interactive TV - MHEG)
- MHP (Multimedia Home Platform)
- DTVi (Digital TV interactive)

Visit the broadcaster's website for more information to see which interactive system is available in your country.

Here are some examples of interactive activities you can enjoy:

- View information about TV programmes
- Take part in a quiz or competition
- Play games
- Shop online
- Pay for a video-on-demand (VOD) programme
- Vote
- Chat

---

## What you need

To enjoy this service, you need:

- Digital channels with interactive services
- A wired or wireless home network, connected through a Universal Plug and Play router (uPnP).

For network connection, see **Connect your TV > Connect to a network and the Internet** (Page 57).

---

## Access interactive TV

You can identify channels that offer interactive services by a message that invites you to press the **Red button** or **OK** to access an interactive programme.

1. Switch to a digital channel with interactive services.

While the application is loading, a blinking symbol is displayed. When the application has loaded, an icon is displayed.

2. Press the **Red button** or **OK** to launch the interactive application.
3. Follow the onscreen instructions and use your remote control to navigate the interactive pages.

# 3 Use more of your TV

## Pause TV

### What you can do

While you watch a digital channel, you can pause a programme to answer a phone call or to have a break. The broadcast is stored on a USB hard drive that is connected to the TV. You can resume playback of the programme at any time.

#### Note:

- You can pause a programme for a maximum of 90 minutes.

### What you need

- Tune your TV to receive digital channels. See **Change your TV settings > Channels > Automatic installation** (Page 36).
- Connect a USB 2.0 compatible hard drive with a minimum capacity of 4 GB and a minimum transfer speed of 30 megabits per second. For optimal performance, use a hard drive with 32 GB of disk space.

### Install USB hard drive

To pause TV, you must connect a USB hard drive to the TV and format it.

If the TV does not recognise the USB hard drive, use a PC to format it to NTFS or FAT32 system, then try again.

#### Caution:

- TP Vision is not responsible if the USB hard drive is not supported, nor is it responsible for damage to or loss of data in the device.
- Formatting removes all data from the connected USB hard drive.

- The USB hard drive is formatted exclusively for this TV. Keep it permanently connected to the TV. You cannot access the contents of the USB hard drive from another TV or PC.
- Do not overload the USB port. If you connect a USB hard drive device that consumes more than 500mA power, make sure that it is connected to its own external power supply.

#### Note:

- Make sure that the TV and the USB hard drive are switched off.
- While you are formatting the USB hard drive, do not connect other USB devices to the TV.

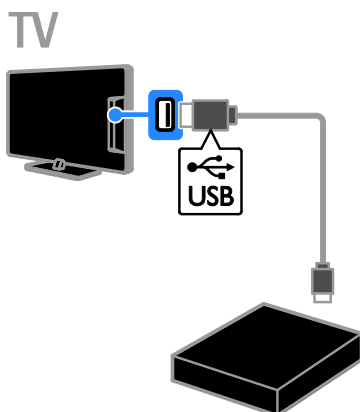

1. Connect the USB hard drive directly to the TV, or if you intend to connect other USB devices in future, connect the USB hard drive through a USB hub. Make sure that the USB hub is connected to the **USB 1** port on the TV.
2. Switch on the TV and the USB hard drive, if it has an external power source.
3. Switch to a digital TV channel.
4. Press **III** to start formatting the USB hard drive.
5. Follow the onscreen instructions to complete the formatting process.

**Warning:** The formatting process may take some time. Do not switch off the TV or disconnect the USB hard drive until this process is complete.

---

## Pause a live TV broadcast

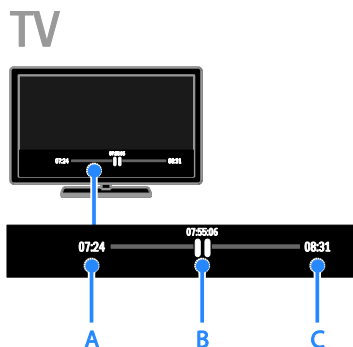

1. On a digital channel, press **II** to pause a TV programme.
2. Press **▶** to continue watching.

The status bar shows the following time indicators:

- A.** When the programme was paused for the first time.  
**B.** Where the paused programme is currently playing.  
**C.** Where the live programme is currently broadcast.

- To watch the stored broadcast, press **◀◀** or **▶▶** to search backward or forward.
- To change playback speed, press **◀◀** or **▶▶** repeatedly.
- To watch the live TV broadcast, press **■**.

**Note:** If a recording is in progress, you cannot pause the TV broadcast.

### The stored broadcast on the USB hard drive is deleted if you:

- Disconnect the USB hard drive.
- Start recording a TV programme.
- Access Smart TV.
- Switch the TV to standby.
- Switch to another channel.
- Switch source to watch from a connected device, such as a Blu-ray disc player or digital receiver.

---

## Record TV shows

---

### What you can do

If your TV can receive programme guides, you can record TV programmes onto a USB hard drive. You can record both current TV programmes as well as future TV programmes.

#### Note:

- Recording is only supported in countries with programme guides.
- In Nordic countries, the TV provides limited support for subtitles while recording TV programmes.

---

### What you need

- Tune your TV to receive digital TV channels such as DVB broadcasts. See **Change your TV settings > Channels > Automatic installation** (Page 36).
- Connect a USB 2.0 compatible hard drive with a minimum capacity of 32 GB and a minimum transfer speed of 30 megabits per second. For optimal performance, use a hard drive with 250 GB of disk space. You can use the same USB hard drive to record and pause TV shows.

---

### Install USB hard drive

To record TV shows, you must connect a USB hard drive to the TV and format it.

If the TV does not recognise the USB hard drive, use a PC to format it to NTFS or FAT32 system, then try again.

#### Caution:

- TP Vision is not responsible if the USB hard drive is not supported, nor is it responsible for damage to or loss of data in the device.
- Formatting removes all data from the connected USB hard drive.
- The USB hard drive is formatted exclusively for this TV. Keep it permanently connected to the TV. You cannot access the contents of the USB hard drive from another TV or PC.



- Do not overload the USB port. If you connect a USB hard drive device that consumes more than 500mA power, make sure that it is connected to its own external power supply.

**Note:**

- Make sure that the TV and the USB hard drive are switched off.
- While you are formatting the USB hard drive, do not connect other USB devices to the TV.

## TV

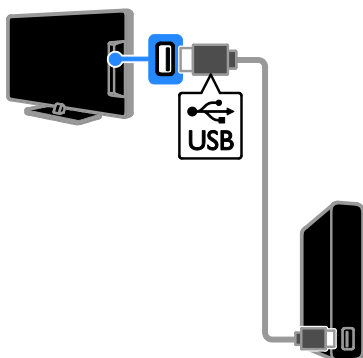

1. Connect the USB hard drive directly to the TV, or if you intend to connect other USB devices in future, connect the USB hard drive through a USB hub.
2. Switch on the TV and the USB hard drive, if it has an external power source.
3. Switch to a digital TV channel.
4. Press **||** to start formatting the USB hard drive.
5. Follow the onscreen instructions to complete the formatting process.

**Warning:** The formatting process may take some time. Do not switch off the TV or disconnect the USB hard drive until this process is complete.

## Start recording

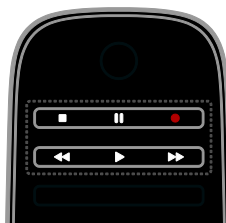

### One-touch recording

You can record the programme you are currently watching with a single button.

1. While you watch TV, press **●**. Recording starts immediately. A pop-up window is displayed, indicating the end time of the programme.
2. Optional: Use the **Navigation buttons** to mark the end time of the recording.
3. Select **[Confirm]**, then press **OK**.
4. To stop recording, press **■**.

**Note:**

- While recording, you cannot switch TV channels or pause a TV broadcast.
- If TV guide information is not available, a default time of 30 minutes is set for recording. You can change this if needed.

## Schedule recordings

### View programme information

Depending on the status of a programme, you can start watching it or schedule to record the programme.

1. Press **▲**.
2. Select **[TV guide]**.
3. Select a channel and programme, then press **OK**.

The programme information is displayed.

**Note:** If you schedule recordings while you are away, make sure that you leave the TV in standby and keep the USB hard drive switched on.

## Schedule a TV programme recording

You can schedule a recording of an upcoming programme that will be broadcast today or in up to eight days' time. You can also schedule a timed recording that is not linked to any programme, if programme guide information is not available.

1. Press **⏠**, then select **[TV guide]**.
2. Select the channel and programme to record.
3. Optional: To record a programme that will be broadcast on another day: press **≡** **OPTIONS**, select **[Change day]**, then select another day.
4. Select **[Record]**.  
A pop-up window is displayed.
5. Select and change the recording details with the **Numeric buttons** and **Navigation buttons**.
6. Select **[Confirm]**, then press **OK**.

## Change a scheduled recording

1. Press **⏠**.
2. Select **[Recordings]**, then press **OK**.  
A list of scheduled recordings is displayed.
3. Select the recording, then select **[Adjust time]**.
4. Change the recording time as needed, then select **[Confirm]**.

## Cancel a scheduled recording

1. Press **⏠**.
2. Select **[Recordings]**, then press **OK**.  
A list of recordings is displayed.
3. Select the recording, then select **[Remove]**.  
The schedule recording is cancelled.

---

## Watch recordings

1. Press **⏠**.
2. Select **[Recordings]**, then press **OK**.  
A list of recordings is displayed.
3. Select a recording from the list, then press **OK**.  
The recording starts to play.

## Sort recordings

1. Press **⏠**.
2. Select **[Recordings]**, then press **OK**.  
A list of recordings is displayed.
3. Press **≡** **OPTIONS**.
4. Select an option to sort by name, date, expiry date or type, then press **OK**.

### Note:

- If a broadcaster limits the number of days that a recording can be viewed after the programme has been broadcast, the list of recordings shows the number of days before the recording expires.
- If a recording has expired or if a broadcaster restricts playback, the recording cannot be played.
- If a scheduled recording is prevented by the broadcaster or if the recording does not occur as per schedule, it is marked as **[Failed]** in the recordings list.

---

## Delete recordings

The **[Recordings]** page shows a list of all recordings and the remaining USB hard disk space. You can delete recordings to free up disk space.

1. Press **⏠**.
2. Select **[TV guide] > [Recordings]**, then press **OK**.  
A list of recordings is displayed.
3. Select the recording, then select **[Remove]**.

## Use Skype™

### What you can do

- Talk to anyone else on Skype, anywhere in the world, for free.
- Make low-cost calls to phones and mobiles. A Skype subscription is required. Visit [www.skype.com](http://www.skype.com).
- Participate in conference calls.
- Send and receive voicemails.
- Forward a call.
- Manage your online status, 'mood' message and profile information.



#### Note:

- No emergency calls with Skype. Skype is not a replacement for your telephone and cannot be used for emergency calls.
- This TV comes with Skype pre-installed on it and ready to use. You do not need to install or download any files for using Skype. Simply connect a Philips TV video camera to use Skype.

### What you need

- A Philips TV video camera, PTA317/00 (sold separately), with built-in microphone. See **Connect your TV > Connect more devices > Video call camera** (Page 53).
- An Internet connection.
- A wired or wireless home network. For network connection, see **Connect your TV > Connect to a network and the Internet** (Page 57).
- A Skype account. You can create a Skype account on this TV or from your computer.

**Tip:** If you have connected a USB keyboard to this TV, you can enter text from your keyboard. For keyboard connections, see **Connect your TV > Connect more devices > Keyboard and mouse**.

## Start Skype

### Sign in to your account

1. Press **⬆**, then select **[Skype]**.
2. Enter your **[Skype Name]** and **[Password]**. To enter text, select each field and press **OK** to access the onscreen keyboard.
3. Select **[Sign in]**, then press **OK**. The Skype menu is displayed.

**Tip:** If you have forgotten your password, start Skype on your computer. Visit [www.skype.com](http://www.skype.com) to retrieve your password.

### Create an account

If you do not have a Skype name and password, you can create an account from your TV.

1. Select **[Don't have a Skype Name?]**, then press **OK**.
2. Read the Skype End User License Agreement, Terms of Service and Privacy Statement. Once complete, select **[Accept]** and press **OK**.
3. When prompted, add information about your name, Skype name, password and email address.
4. Once complete, select **[Create an account]** and press **OK**.

Your new account is accepted and you are signed in.

If prompted, follow the onscreen instructions to make changes to the entries.

### Sign out from Skype

In the Skype menu, select **[Sign Out]**, then press **OK**.

---

## Manage contacts

You can add and view contacts that are online or offline. You can also block or unblock a selected contact.

### Add a contact

1. In the Skype menu, select **[Contacts]**, then press **OK**.
2. Press **≡ OPTIONS**, then select **[Add Skype contact]** or **[Add SkypeOut Contact]**.
3. Press **OK** to display the onscreen keyboard.
4. Follow the on-screen instructions to enter the details.  
A list of profiles is displayed.
5. Select a contact, then press **OK**.

An invitation request is sent to the contact. The contact name appears offline until the contact accepts the request.

### Accept a contact request

Other Skype users can invite you to be on their contact list. You will be notified of their request, which you can accept or decline.

### Rename a contact

1. In the Skype menu, select **[Contacts]**, then press **OK**.
2. Select a contact, then press **≡ OPTIONS**.
3. Select **[Rename]**, then press **OK**.
4. Follow the onscreen instructions to edit the information.

### Block a contact

1. In the Skype menu, select **[Contacts]**, then press **OK**.
2. Select the contact, then press **≡ OPTIONS**.
3. Select **[Block]**, then press **OK**. When prompted, select **[Yes]** then press **OK**.

### Unblock a contact

1. In the Skype menu, select **[Settings]** > **[Blocked Contacts]**.
2. Select the blocked contact, then press **OK**.
3. Follow the on-screen instructions to unblock the contact.

## Contact info

To view the details of a contact, select a contact. The contact details are displayed on the right of the TV screen.

### Contact history

To view the calls which you have had with a contact, select **[History]**.

To open previous conversations, select a conversation and press **OK**.

**Note:** When you sign in with another Skype account on this TV, the history of your previous account is cleared.

### Online status

To see if a contact is online, check the online status icon next to the contact. Your online status is also shown on your contacts' page.

To change your online status:

1. In the Skype menu, select your Skype name, then press **OK**.
2. Select **[Online Status]**, then press **OK**.
3. Select a status, then press **OK**.

---

## Make voice and video calls

### Make a voice call

You can make a Skype call without video. **Note:** Make sure that a video camera is connected for voice calls too.

1. In the Skype main menu, select **[Contacts]**, then press **OK**.
2. Select the contact, then press **OK**.
3. Select **[Call]**, then press **OK**.

### Voice call options

During a call, press **≡ OPTIONS** to access these options:

- **[Mute]:** Mute the microphone.
- **[Hold]:** Put the call on hold.
- **[End call]:** End the call.
- **[Dial pad]:** Access the dial pad.
- **[Start My Video]:** Start video camera.

### Make a video call

With video calls, you can talk face-to-face with live video from your TV for free.

1. From the Skype menu, select **[Contacts]**, then press **OK**.
2. Select the contact, then press **OK**.
3. Select **[Video call]**, then press **OK**.

## Full-screen view

If your contact has a camera connected and accepts the call, you can see the person on your TV, in full screen. To check what your contact can see, view the display in the small screen on your TV.

1. During the call, press **III** **OPTIONS**.
2. Select **[Full view]**, then press **OK**.

## Zoom and pan your video

1. In **[Full view]**, select **[Zoom]+/-** to zoom in or zoom out.

A zoom and pan icon appears above the video display.

2. Use the **Navigation buttons** on the remote control to pan or tilt the camera.

## Video call options

During a video call, press **III** **OPTIONS** to access these options:

- **[Full view]**: See your contact in full-screen view.
- **[Dial pad]**: Access dial pad.
- **[Hold]**: Put the call on hold. Full view will be stopped.
- **[Mute]**: Mute the microphone.
- **[Stop My Video]**: Stop the video feed to your contact's screen.

## Call a phone

With Skype, you can call land line phones and mobile phones.

### Note:

No emergency calls with Skype. Skype is not a replacement for your telephone and cannot be used for emergency calls.



Before you can make a call, you will need to purchase Skype Credits or buy a Skype subscription on your computer. For more information, see **Use more of your TV > Use Skype > Skype settings**. (Page 30)

1. In the Skype menu, select **[Call phones]**, then press **OK**.
2. Select **[Dial pad]** to access the on-screen dial pad or enter the telephone number with the **Numeric buttons**.
3. Once complete, select **[Call]**, then press **OK** to start the call.
4. Optional: To mute your microphone during your call, press **III** **OPTIONS**, then select **[Mute]**.
5. To end the voice call, select **[End call]**, then press **OK**.

## Answer a call

If you are signed in to Skype, you are notified of incoming calls while watching TV.

1. A message appears onscreen with the caller's name. Select **[Answer]**, then press **OK**.

To enable video, select **[Answer with video]**, then press **OK**.

2. To decline, select **[Decline]**, then press **OK**.

### Note:

If you accept a call while pausing or recording a TV programme, or while watching rental films, Skype will interrupt the activity going on.

- A paused TV programme is stopped and the programme storage is lost.
- Recording of a TV programme is stopped. You will need to resume recording again after you finish the call.
- Playback of rental films is stopped. To resume watching the rented film, you need to go back to the video store or broadcast service. Some video stores and services do not allow you to restart the film.

---

## Manage voicemails

If someone calls you on Skype and you are offline, they can leave a voice message in your Skype voicemail.

Before you can receive voicemail, you need to activate voicemail in your Skype account – this can only be done on your computer.

### Play voicemail

1. In the Skype menu, select **[History]** and press **OK**.
2. Select **[Voicemails]**, then press **OK**.
3. Select the voicemail, then press **OK** to play it.

### Delete voicemails

1. Select the voicemail from the list and press **≡ OPTIONS**.
2. Select **[Delete voicemail]**, then press **OK**.

---

## Skype settings

### Skype Credit

With Skype Credit, you can call land lines or mobile phones on your TV. To purchase Skype Credit, you need to log in to your Skype account on your computer. The amount of Skype Credit you purchase will appear when you log in to your Skype account on your TV.

### Automatic sign in

1. In the Skype menu, select **[Settings]**, then press **OK**.
2. Select **[General settings]** > **[Sign me in when Skype starts]**, then press **OK**.

### Change your profile picture

1. In the Skype menu, select your **Skype name**, then press **OK**.
2. Select **[Profile picture]**, then press **▶**.
3. Choose a picture, select **[Apply]**, then press **OK**.

### Change your Skype password

1. In the Skype menu, select **[Settings]**, then press **OK**.
2. Select **[Change Password]**, then press **▶**.
3. Follow the onscreen instructions to enter your current and new passwords.
4. Once complete, select **[Apply]**, then press **OK**.

---

## Play games

### What you can do

On this TV, you can play regular or two-player\* games, in full-screen with optimised picture settings for games.

\*For certain models only.

---

### What you need



- Connect your game console to this TV. See **Connect your TV > Connect devices > Game console** (Page 48). If the TV automatically adds the game console to the Source menu, it also applies the game sound preset when you start playing games (for certain models).

---

### Start gaming

1. Press **☑ SOURCE**.
2. Select the game console, then press **OK**.
3. If needed, load a game disc on the game console, then select a game to play.
4. Follow the onscreen instructions to start gaming.

---

### Game settings

#### Picture setting for games

You can optimise the TV display for gaming without picture lag.

1. Press **🏠**.
2. Select **[Setup]** > **[TV settings]** > **[Picture]**, then press **OK**.
3. Select **[Game or computer]** > **[Game]**.

#### Sound preset for games

You can optimise sound effects for gaming.

1. Press **≡ OPTIONS**.
2. Select **[Picture and sound]** > **[Sound style]** > **[Game]**, then press **OK**.

The TV is ready for gaming.

**Note:** When your gaming session ends, switch back to your usual sound setting.

---

## View Text

---

### Select a page

While you watch channels that broadcast text, you can view the text.

1. Select a channel that broadcasts text, then press **TEXT**.
2. Select a page in one of the following ways:
  - Enter the page number with the **Numeric buttons**.
  - Press **CH + / CH -** to view the next or previous page.
  - Press the **Colour buttons** to select a colour coded item.

---

### Text options

1. While you view text, press **III** **OPTIONS**.
2. Select an option:
  - **[Freeze page] / [Unfreeze page]:** Freeze or unfreeze the current page.
  - **[Dual screen] / [Full screen]:** Enable or disable dual screen text. Dual screen displays both the current channel and the text broadcast on two halves of the TV screen.
  - **[T.O.P. overview]:** Table Of Pages (T.O.P.) text broadcasts allow you to jump from one subject to another without entering page numbers.
  - **[Enlarge] / [Normal view]:** Zoom in on the page. Press the **Navigation buttons** to move around the enlarged view.
  - **[Reveal]:** Hide or reveal hidden information on a page, such as solutions to riddles or puzzles.
  - **[Cycle subpages]:** If subpages are available, each is shown automatically.
  - **[Language]:** Switch to a different language group to correctly display different character sets.
  - **[Text 2.5]:** View text with more colours and better graphics than normal text. If Text 2.5 is broadcast by a channel, it is switched on by default.

---

## Text language

For digital TV channels where the broadcasters provide different text languages, you can select your preferred primary and secondary languages.

1. Press **▲**.
2. Select **[Setup] > [Channel settings]** or **[Satellite settings]**.
3. Select **[Languages] > [Primary Text]** or **[Secondary Text]**.
4. Select a language, then press **OK**.

---

## Subpages

If the text page contains several subpages, you can view each subpage in succession. These subpages are shown on a bar next to the main page number.

Press **◀** or **▶** to select them.

---

## Search

You can search for a word or number that exists on the current text page.

1. While you are viewing text, press **OK** to highlight the first word or number.
2. Press the **Navigation buttons** to skip to the word or number to search.
3. Press **OK** to begin the search.
4. To exit the search, press **▲** until no word or number is highlighted.

---

## Digital text

If a digital TV channel's broadcaster offers dedicated digital text or interactive services, you can view digital text. Channels such as BBC1 may have digital text with more interactive features.

**Note:** Digital text services are blocked when subtitles are broadcast and switched on. See **Change your TV settings > Language settings > Subtitles on digital channels** (Page 40).

When in digital text:

- Press the **Navigation buttons** to select or highlight items.
- Press the **Colour buttons** to select an option, then press **OK** to confirm or activate.

---

## Set locks and timers

---

### Clock

You can display a clock on the TV. The clock displays the time that is broadcast by your TV service operator.

#### Display the TV clock

1. While you watch TV, press **III** **OPTIONS**.
2. Select **[Clock]**, then press **OK**.

The clock is displayed on the top right-hand corner of the TV screen.

#### Change the clock mode

You can change the clock mode to automatic or manual. By default, it is set to automatic mode, which automatically synchronises it to Coordinated Universal Time (UTC). If your TV cannot receive UTC transmissions, change the clock mode to **[Manual]**.

1. While you watch TV, press **⬆**.
2. Select **[Setup]** > **[TV settings]** > **[General settings]**.
3. Select **[Clock]** > **[Auto clock mode]**.
4. Select **[Automatic]**, **[Manual]** or **[Country dependent]**, then press **OK**.

#### Change the time zone

In countries with clock transmission data, you can change the time zone if **[Auto clock mode]** > **[Automatic]** or **[Country dependent]** is selected.

1. In the **[Clock]** menu, select **[Time zone]**.
2. Select your time zone, then press **OK**.

### Set daylight saving time

In countries with clock transmission data, you can enable or disable daylight saving time if **[Auto clock mode]** > **[Automatic]** or **[Country dependent]** is selected.

1. In the **[Clock]** menu, select **[Daylight saving]**.
2. Select **[Standard time]** or **[Daylight saving time]**, then press **OK**.

### Set the clock manually

You can set the date and time manually. Before you start, set the clock mode to **[Manual]**.

1. In the **[Clock]** menu, select **[Date]** or **[Time]**, then press **OK**.
2. Set the time or date with the **Navigation buttons**.
3. Select **[Done]**, then press **OK**.

---

### Sleep timer

You can switch the TV to standby after a specified time. During the countdown to the specified time, you can switch off your TV earlier or reset the sleep timer.

1. Press **⬆**.
2. Select **[Setup]** > **[TV settings]** > **[General settings]** > **[Sleep timer]**.
3. Select the sleep timer duration. The sleep timer can be set up for to 180 minutes. To switch off the sleep timer, set it to zero minutes.
4. Press **OK** to activate the sleeptimer. After the specified time, the TV switches to standby.



## Child lock

To protect children from unsuitable TV programmes, you can lock the TV or block age rated programmes.

### Set or change the child lock code

1. Press **⬆**.
2. Select **[Setup]** > **[Channel settings]** or **[Satellite settings]** > **[Child lock]**.
3. Select **[Set code]** or **[Change code]**.
4. Enter the code with the **Numeric buttons**.

**Tip:** If you access the channels from the channel list, you are prompted to enter your lock code. If you forget your code, enter '8888' to override any existing codes.

### Lock or unlock channels

1. In the child lock menu, select **[Channel lock]**.
2. Enter the child lock code with the **Numeric buttons**.
3. Select the channels to lock or unlock.  
Restart the TV to activate the lock.

### Note:

If you access the channels from the channel list, you are prompted to enter your lock code.

## Parental rating

You can set your TV to display only programmes with age ratings lower than your child's age. This restriction only applies to digital channels from broadcasters that rate their programmes according to age.

1. Press **⬆**.
2. Select **[Setup]** > **[Channel settings]** or **[Satellite settings]**.
3. Select **[Child lock]** > **[Parental rating]**.  
You are prompted to enter the child lock code.
4. Enter the child lock code with the **Numeric buttons**.
5. Select an age rating, then press **OK**.

All programmes above the selected age rating are blocked.

For information on child lock codes, see **Use more of your TV > Set locks and timers > Child lock** (Page 32).

# 4 Change your TV settings

---

## Picture and sound

---

### Settings assistant

You can select picture and sound settings with the help of the settings assistant, which demonstrates the effect of your chosen setting immediately.

1. While you watch TV, press **⬆️**.
2. Select **[Setup]** > **[Quick picture and sound settings]**, then press **OK**.
3. Select **[Continue]**, then press **OK**.
4. Follow the onscreen instructions to choose your preferred settings.

---

### More picture settings

You can change the settings in the Picture menu.

1. Press **⬆️**.
2. Select **[Setup]** > **[TV settings]** > **[Picture]**, then press **OK**.
3. Select a setting to change, then press **OK**.
  - **[Picture style]**: Select a predefined picture setting.
  - **[Restore style]**: Restores the previously selected picture settings.
  - **[Backlight contrast]**: Adjust the brightness of the display backlight.
  - **[Colour]**: Adjust the colour saturation of the picture.
  - **[Sharpness]**: Adjust the sharpness of the picture.
  - **[Noise reduction]**: Select the amount of noise reduction for the picture.
  - **[MPEG artifact reduction]**: Smoothen transitions and haziness in the digital picture.
  - - **[Digital Crystal Clear]**: Fine-tune each pixel to match surrounding pixels and produce a brilliant, high-definition image.
    - **[Advanced sharpness]**: Enable superior sharpness, especially on lines and contours in the picture
    - **[Dynamic contrast]**: Dynamically enhance the details in the dark, medium and light areas of the picture.
    - **[Dynamic backlight]**: Select a backlight level to optimise dynamic power consumption and picture contrast.
    - **[Colour enhancement]**: Dynamically enhance the vividness and details of colours.
- **[Advanced]**: Access advanced settings such as gamma, tint settings and video contrast settings.
  - **[Gamma]**: Adjust the non-linear setting for picture luminance and contrast.
  - **[Tint]**: Change the colour balance.
  - **[Custom tint]**: Customise colour balance setting. Only available if **[Tint]** > **[Custom]** is selected.
  - **[Video contrast]**: Adjust video contrast.
  - **[Brightness]**: Adjust screen brightness.
  - **[Hue]**: Compensate colour variations in NTSC transmissions.
- **[Game or computer]**: When viewing content from a connected game console, select **[Game]** to apply game settings. When a computer is connected through HDMI, select **[Computer]**. Make sure that **[Format and edges]** > **[Picture format]** > **[Unscaled]** is selected to view maximum detail.
- **[Format and edges]**: Access advanced settings to control the display format of the picture.
  - **[Picture format]**: Change the picture format.
  - **[Screen edges]**: Change the picture size.
  - **[Picture shift]**: If available, move the position of the picture.

---

## More sound settings

You can change the settings in the Sound menu.

1. Press **⬆**.
2. Select **[Setup]** > **[TV settings]** > **[Sound]**, then press **OK**.
3. Select a setting to change, then press **OK**.
  - **[Sound style]**: Access predefined sound settings.
  - **[Restore style]**: Restore the last selected predefined sound setting.
  - **[Bass]**: Adjust the bass level of the speaker and headphones.
  - **[Treble]**: Adjust the treble level of the speaker and headphones.
  - **[Surround mode]**: Select a surround sound mode to enhance your audio experience.
  - **[Auto incredible surround 3D]**: Select a surround sound mode to enhance your audio experience in 3D mode. For certain models.
  - **[Headphone volume]**: Adjust headphone volume.
  - **[Advanced]**: Access advanced settings to enhance your audio experience.
    - **[Auto volume levelling]**: Enable the reduction of sudden volume changes, for example, when switching channels.
    - **[TV speakers]**: Select the preferred speakers to stream audio from the TV. See **Connect your TV > Set up EasyLink devices > Select speaker output** (Page 56).
    - **[Clear Sound]**: Enhance sound quality.
    - **[Audio Out format]**: Select the type of audio output through the digital audio output connector. Choose between **[Multichannel]** and **[Stereo]**.
    - **[Audio Out levelling]**: Set the output level for stereo audio. Select **[Less]** for a certain amount of loss in intensity or signal strength. Select **[More]** for no loss in intensity or signal strength.
    - **[HDMI 1 - ARC]**: Enable audio output from the ARC-compliant device connected to the HDMI 1 connector.

- **[Audio out delay]**: Automatically sync the image on the TV to the audio from a connected home theatre. You do not need to use this setting when connecting the TV to a Philips home theatre.

- **[Audio out offset]**: Adjust the setting for audio output delay. Available if **[Audio out delay]** is switched on.

---

## Audio format

### Digital channels

If a digital TV channel broadcaster streams audio in multiple formats, you can select an audio format.

1. Press **⬆**.
2. Select **[Setup]** > **[Channel settings]** or **[Satellite settings]** > **[Languages]** > **[Preferred audio format]**.
3. Select an option, then press **OK**.
  - **[Standard]**: Receive standard audio format (MPEG).
  - **[Advanced]**: Receive advanced audio formats, if available (AAC, Dolby Digital or Dolby Digital Plus).

### Analogue channels

If an analogue TV channel broadcaster streams stereo audio in multiple formats, you can select an audio format.

1. Press **⬆**.
2. Select **[Setup]** > **[Channel settings]** or **[Satellite settings]** > **[Mono/Stereo]**.
3. Select a setting, then press **OK**.

---

## Reset picture and sound

You can restore the default picture and sound settings, while the channel installation settings remain the same.

1. While you watch TV, press **⬆**.
2. Select **[Setup]** > **[TV settings]** > **[General settings]** > **[Factory settings]**, then press **OK**.
3. Select **[Reset]**, then press **OK**.

All TV settings (except for channel settings) are reset to the default factory settings.

---

# Channels

---

## Automatic installation

When the TV was switched on for the first time, a full installation of channels was performed.

To change your language, country and reinstall all available TV channels, you can run this full installation again.

### Start installation

**Note:** If you are prompted to enter a code, enter '8888'.

1. Press **⬆**.
2. Select **[Setup]** > **[Search for channels]** > **[Reinstall channels]**, then press **OK**.
3. Select your country, then press **OK**.
4. Select your network, then press **OK**:
  - **[Antenna (DVB-T)]**: Access free-to-air antenna transmissions.
  - **[Cable (DVB-C)]**: Access cable transmissions.
5. Follow the onscreen instructions to select other options, if any.  
The start menu for channel search is displayed.
6. Select **[Start]**, then press **OK**.
7. Once the channel search is complete, select **[Finish]**, then press **OK**.

**Tip:** Press **≡ LIST** to see the channel list.

**Note:** When digital TV channels are found, the list of installed channels may display empty channel numbers. You can rename or reorder these channels.

---

## Install analogue channels

You can search and store analogue TV channels one by one.

### Step 1: Select your system

**Note:** Skip this step if your system settings are correct.

1. While you watch TV, press **⬆**.
2. Select **[Setup]** > **[Channel settings]** > **[Channel installation]**.
3. Select **[Analogue: Manual installation]** > **[System]**, then press **OK**.
4. Select the system for your country or region, then press **OK**.

### Step 2: Search and store new TV channels

1. While you watch TV, press **⬆**.
2. Select **[Setup]** > **[Channel settings]** > **[Channel installation]**.
3. Select **[Analogue: Manual installation]** > **[Search channel]**, then press **OK**.
4. Find the channel:
  - If you know the channel frequency, enter it with the **Navigation buttons** or **Numeric buttons**.
  - If you do not know the channel frequency, search for the next frequency that has a strong signal. Select **[Search]**, then press **OK**.
5. After you have found the correct channel, select **[Done]**, then press **OK**.
6. Select **[Store as new channel]**, then press **OK** to store the new TV channel.

**Note:** If the reception is poor, reposition your antenna and repeat the procedure.

---

## Install digital channels

If you know the channel frequency of the channels you want to install, you can search and store digital channels one by one. For best results, contact the service provider.

1. Press **⬆**.
2. Select **[Setup]** > **[Channel settings]** > **[Channel installation]**.
3. Select **[Digital: Reception test]** > **[Search channel]**, then press **OK**.
4. Press the **Numeric buttons** to enter the channel frequency.
5. Select **[Search]**, then press **OK**.
6. When the channel is found, select **[Store]**, then press **OK**.

---

## Fine-tune analogue channels

If the reception of an analogue TV channel is poor, you can fine-tune the TV channel.

1. Press **⬆️**.
2. Select **[Setup]** > **[Channel settings]** > **[Channel installation]**.
3. Select **[Analogue: Manual installation]** > **[Fine tune]**, then press **OK**.
4. Press **▲** or **▼** to fine-tune the channel.
5. When you have selected the correct channel frequency, select **[Done]**, then press **OK**.
6. Select an option, then press **OK**.
  - **[Store current channel]**: Store the channel under the current channel number.
  - **[Store as new channel]**: Store the channel under a new channel number.

---

## Update channel list

When the TV was switched on for the first time, a full installation of channels was performed. By default, when there are changes to these channel lists, the TV updates them automatically. You can also switch off the automatic update or manually update the channels.

**Note:** If you are prompted to enter a code, enter '8888'.

### Automatic update

To add or remove digital channels automatically, leave the TV in standby mode. The TV updates channels and stores new channels everyday. Empty channels are removed from the channel list.

### Switch off the channel update message

If a channel update is performed, a message is displayed at startup. You can switch off this message.

1. Press **⬆️**.
2. Select **[Setup]** > **[Channel settings]** or **[Satellite settings]**.
3. Select **[Channel installation]** > **[Channel update message]**.
4. Select **[Off]**, then press **OK**.

### Switch off automatic updates

In the **[Channel installation]** menu, select **[Automatic channel update]** > **[Off]**.

### Update channels manually

1. Press **⬆️**.
2. Select **[Setup]** > **[Search for channels]** > **[Update channels]**, then press **OK**.
3. Follow the onscreen instructions to update the channels.

---

## Copy channels

**ATTENTION:** This feature is intended for dealers and service personnel.

You can copy channel lists from one Philips TV to another through a USB storage device. You do not need to search for channels or install them again on the second TV. The channel list file is small enough to fit on any USB storage device.

### What you need

Two Philips TVs that have these properties:

- The same country setting
- The same year range
- The same DVB type, as indicated by the suffix (H, K, T, D/00) in the model name
- The same settings for satellite channels, including the number of LNB satellites
- The same hardware type, as indicated by the sticker on the back of the TV. For example: TPM10.1E LA.
- Compatible software versions

**Note:** If you are prompted to enter a code, enter '8888'.

### Step 1: Check the country setting

1. Switch on the first TV (with the channels that you want to copy to the second TV).
2. Press **⬆️**.
3. Select **[Setup]** > **[Search for channels]** > **[Reinstall channels]**, then press **OK**. The country menu is displayed.
4. Make a note of the current setting.
5. Press **↶**.
6. Press **[Cancel]** to exit.

### Step 2: Copy channel list to USB

1. Connect a USB storage device to the first TV (with the channels installed on it).
2. Press **⬆**.
3. Select **[Setup] > [Channel settings]** or **[Satellite settings]**.
4. Select **[Channel installation] > [Copy channel list] > [Copy to USB]**, then press **OK**.

The channel list is copied to the USB storage device.

5. Disconnect the USB storage device.

### Step 3: Copy channels to a TV with no channels installed

1. Switch on the second TV, on which you want to copy the channel list. Initial installation starts.
2. Follow the onscreen instructions and select the same country as the TV whose channel list you want to copy.
3. Skip the search for channels.
4. Connect the USB storage device.
5. Press **⬆**.
6. Select **[Setup] > [Channel settings]** or **[Satellite settings]**.
7. Select **[Channel installation] > [Copy channel list] > [Copy to TV]**, then press **OK**.

The channel list is copied to the TV storage device.

8. Disconnect the USB storage device.

### Step 3: Copy channels to a TV with pre-installed channels

1. Switch on the second TV, on which you want to copy the channel list.
2. Press **⬆**.
3. Select **[Setup] > [Search for channels] > [Reinstall channels]**, then press **OK**.  
The country menu is displayed.
4. Make sure that the country setting is the same as for the first TV.
5. Press **↩**.
6. Press **[Cancel]** to exit.
7. If the country setting is different, reinstall the second TV to match the country setting of the first TV. See **Change your TV settings > Reset all** (Page 43).
8. Connect the USB storage device to the second TV.
9. Press **⬆**.
10. Select **[Setup] > [Channel settings]** or **[Satellite settings]**.
11. Select **[Channel installation] > [Copy channel list] > [Copy to TV]**, then press **OK**.

The channel list is copied to the second TV.

12. Disconnect the USB storage device.

# Satellite settings

## What you can do

This TV can receive signals from 4 different low noise block-down converters (LNBs). An LNB is mounted at the end pole of the dish antenna and captures signals from a satellite.

### Note:

- Satellite reception is available for certain models only. **[Search for satellite]** is only available if the TV supports DVB-S.
- To receive satellite channels, connect a satellite receiver to the SAT connector on your TV.

## Install satellite channels

### Reinstall satellites

1. While you watch TV, press **⬆**.
2. Select **[Setup]** > **[Search for satellite]** > **[Reinstall satellites]**.
3. Follow the onscreen instructions to complete the installation.
4. Once complete, select **[Finish]**, then press **OK**.

### Select connection type

When you install satellite channels, you need to set the connection type. The number of LNBs on your dish antenna determines the number of satellite channels you can install.

1. While you reinstall satellites, select **[Settings]**, then press **OK**.
2. Select **[Connection type]**.
3. Select a setting, then press **OK**.
  - **[1 satellite (Single LNB)]**: Select if you have only one LNB.
  - **[2 satellites (DiSEqC Mini)]**: Select if you have 2 LNBs.
  - **[3 or 4 satellites (DiSEqC 1.0)]**: Select for 3 or 4 LNBs.
  - **[Uncable for 1 satellite]**: Select if you have a Uncable setup with 1 satellite.
  - **[Uncable for 2 satellites]**: Select if you have a Uncable setup with 2 satellite.

## Manual installation

If a transponder is skipped during installation, you can test the signal strength of a transponder or add a new transponder.

1. While you watch TV, press **⬆**.
2. Select **[Setup]** > **[Search for satellite]** > **[Manual installation]**, then press **OK**.
3. Select the LNB.
4. If you know the frequency of the transponder (which can include several channels), select **[Frequency]** and set the frequency.
5. Select **[Search]**, then press **OK**.
6. If a new frequency is found, press **[Store]** to add the new transponder with its channels.

## Update satellite channels

1. While you watch TV, press **⬆**.
2. Select **[Setup]** > **[Search for satellite]** > **[Update channels]**.
3. Follow the onscreen instructions to complete the installation.
4. Once complete, select **[Finish]**, and then press **OK**.

## Add and remove satellites

You can add or remove satellites at any time, and install channels from new satellites.

**Note:** Before you add satellites, make sure that the connection type is correct. See **Change your TV settings > Satellite Settings > Install satellite channels** (Page 39).

1. Press **⬆**.
2. Select **[Setup]** > **[Search for satellite]**, then press **OK**.
3. Select **[Add satellite]**, then press **OK**.  
The TV searches for a satellite on the first free LNB. This can take several minutes.
4. If no satellite is found, check the antenna connections and the position of the dish antenna, then select **[Search again]**.
5. If you are satisfied with the added satellite, select **[Next]** to install all channels from the satellite.  
The installation can take several minutes.

## Remove a satellite

1. Press **⬆**.
2. Select **[Setup]** > **[Search for satellite]** > **[Remove satellite]**, then press **OK**.
3. Select the satellites you want to remove, then select **[Remove]** and press **OK**.

---

## Language settings

---

### Menu language

1. While you watch TV, press **⬆**.
2. Select **[Setup]** > **[TV settings]** > **[General settings]** > **[Menu language]**.
3. Select a menu language from the list, then press **OK**.

---

### Audio language

If the TV channel broadcasts multiple or dual audio languages, you can select your preferred audio language.

1. While you watch TV, press **≡ OPTIONS**.
2. For digital channels, select **[Audio language]**. For analogue channels, select **[Dual I-II]**. Press **OK** to confirm your selection.
3. Select from the available languages, then press **OK**.

You can set your preferred primary and secondary audio languages to hear when available.

1. While you watch TV, press **⬆**.
2. Select **[Setup]** > **[Channel settings]** or **[Satellite settings]** > **[Languages]**.
3. Select **[Primary audio language]** or **[Secondary audio language]** and select from the available languages.
4. Press **OK** to confirm.

---

## Subtitles on analogue channels

1. While you watch an analogue TV channel, press **TEXT**.
2. Enter the three-digit page number of the subtitles page, which is usually '888'.  
If available, subtitles are switched on.

---

## Subtitles on digital channels

1. While you watch a digital TV channel, press **≡ OPTIONS**.
2. Select **[Subtitles]**, then press **OK**.
3. Select **[Subtitles off]**, **[Subtitles on]** or **[Automatic]**, then press **OK**.

---

## Subtitle language

When available, you can change the subtitle language for digital channels.

1. While you watch TV, press **≡ OPTIONS**.
2. Select **[Subtitle language]**, then select from the available languages and press **OK**.  
The subtitle language is changed for the specific channel.

You can set your preferred primary and secondary subtitle languages to display when available.

1. While you watch TV, press **⬆**.
2. Select **[Setup]** > **[Channel settings]** or **[Satellite settings]** > **[Languages]**.
3. Select **[Primary subtitle language]** or **[Secondary subtitle language]** and select from the available languages.
4. Press **OK** to confirm.



## Universal access settings

### Switch on

Some digital TV broadcasters provide special audio and subtitle features for people who are hearing or visually impaired. You can switch these features on or off.

1. Press **▲**.
2. Select **[Setup]** > **[TV settings]** > **[General settings]**.
3. Select **[Universal access]** > **[On]** or **[Off]**, then press **OK**.

### Set audio feedback

When you press a button on the remote control or TV, you can set the TV to play a beep.

1. While you watch TV, press **≡ OPTIONS**.
2. Select **[Universal access]** > **[Key beep]** > **[On]**, then press **OK**.

### Hearing impaired access

To make sure that a hearing-impaired audio language is available, press **≡ OPTIONS**, then select **[Audio language]**. Languages that support hearing-impaired audio are indicated with an ear-shaped icon.

#### Switch on hearing-impaired audio and subtitles

1. While you watch TV, press **≡ OPTIONS**.
2. Select **[Universal access]** > **[Hearing impaired]**.
3. Select a setting, then press **OK**.
  - **[Off]**: Switch off hearing impaired features.
  - **[On]**: Switch on hearing impaired audio and subtitles.

### Visually impaired access

To make sure that a hearing-impaired audio language is available, press **≡ OPTIONS**, then select **[Audio language]**. Languages that support visually impaired audio are indicated with an eye-shaped icon.

### Select speakers or headphones

You can choose to hear the visually impaired audio through the TV speakers, headphones or both.

1. While you watch TV, press **≡ OPTIONS**.
2. Select **[Universal access]** > **[Visually impaired]**.
3. Select a setting, then press **OK**.
  - **[Speakers]**: Hear visually impaired audio from speakers only.
  - **[Headphones]**: Hear visually impaired audio from headphones only.
  - **[Speakers + headphones]**: Hear visually impaired audio from speakers as well as headphones.
  - **[Off]**: Switch off visually impaired audio.

**Note:** If the EasyLink remote control is switched on, you cannot select the Green button. To switch off EasyLink, see **Connect your TV > Set up EasyLink devices > What you need** (Page 55).

### Change volume for visually impaired audio

1. While you watch TV, press **≡ OPTIONS**.
2. Select **[Universal access]** > **[Mixed volume]**.
3. Press the **Navigation buttons** to change the volume, then press **OK**.

### Audio effects

1. Press **▲**.
2. Select **[Setup]** > **[Channel settings]** or **[Satellite settings]**.
3. Select **[Languages]** > **[Visually impaired]** or **[Audio effects]**.
4. Select a setting, then press **OK**.
  - **[On]**: Enable audio effects in the visually impaired audio.
  - **[Off]**: Disable audio effects in the visually impaired audio.

### Type of speech

1. Press **▲**.
2. Select **[Setup]** > **[Channel settings]** or **[Satellite settings]**.
3. Select **[Languages]** > **[Visually impaired]** or **[Speech]**.
4. Select a setting, then press **OK**.
  - **[Descriptive]**: Hear descriptive speech in the visually impaired audio.
  - **[Subtitles]**: Hear subtitles in the visually impaired audio.

---

## Other settings

---

### TV demo

You can watch a demo to find out more about the features on this TV.

1. While you watch TV, press **⬆**.
2. Select **[Setup]** > **[Watch demos]**, then press **OK**.
3. Select a demo, then press **OK**.

---

### Home mode

Some TV settings may not be available in **Shop** mode. To make sure that the correct TV settings are applied, set the TV to **Home** mode.

1. While you watch TV, press **⬆**.
2. Select **[Setup]**, then press **OK**.
3. Select **[TV settings]** > **[General settings]** > **[Location]**.
4. Select **[Home]** or **[Shop]**, then press **OK**.
5. Restart the TV.

---

## Update software

---

### Check version

1. Press **⬆**.
2. Select **[Setup]** > **[Software settings]** > **[Current software inf]**, then press **OK**.

The current software version is displayed.

**Caution:** Do not install a lower version of software than the current version installed on your product. TP Vision cannot be held liable or be made responsible for problems caused by a software downgrade.

Update the software through one of these methods:

- update with USB storage device
- update from digital broadcast
- update from the Internet

---

## Update with USB

### What you need

- A USB storage device that has at least 256 megabytes of storage space, is FAT or DOS formatted and has its write protection disabled.
- Access to a computer with a USB connector and Internet access.
- A file archiver program that supports the ZIP file format: for example, WinZip® for Microsoft® Windows® or Stuffit® for Macintosh®.

**Note:** Do not use a USB hard drive.

### Download the latest software

1. Connect the USB flash drive to your computer.
2. On your computer, launch a browser such as Internet Explorer® or Safari®, and see [www.philips.com/support](http://www.philips.com/support).
3. Find your TV and locate the software and drivers available for your TV set. The software upgrade is available as a compressed file (\*.zip).
4. If the software version is higher than the version on your TV, click the software upgrade link.
5. Accept the licence agreement and download the ZIP file to the USB flash drive.

**Note:** Some Internet browsers, such as Mozilla® Firefox® or Google® Chrome®, may download the ZIP file directly to your computer. If this happens, copy the file to your USB flash drive.

6. **For Internet Explorer:** Using a file archiver, extract autorun.upg from the downloaded ZIP file. Do not copy or place the extracted file into a folder.
6. **For Safari:** When the download is complete, autorun.upg is automatically extracted from the ZIP file to your computer. Copy the file to the USB flash drive. Do not copy or place the file into a folder.
7. Eject and disconnect the USB flash drive from the computer.

## Upgrade the TV software

### Caution:

- Do not switch off the TV or remove the USB flash drive during the software upgrade.
- If a power failure occurs during the upgrade, do not remove the USB flash drive from the TV. The TV continues the upgrade as soon as power is restored.
- If an error occurs during the upgrade, retry the upgrade from the beginning. If the error reoccurs, contact Philips Consumer Care.

1. Remove all USB devices such as a Wi-Fi adapter from the TV, then switch on the TV.
2. Connect the USB flash drive to the TV. The software upgrade starts automatically. The upgrade is complete when a notification message appears on screen.
3. Before you restart the TV, disconnect the USB flash drive from the TV.
4. Press **⏻** on the remote control – do not press **⏻** more than once. The TV switches off, then back on again. The upgrade is complete.
5. To prevent accidental updates to the TV software, reconnect the USB flash drive to your computer and delete autorun.upg.

---

## Update from digital broadcast

When available, the TV can receive software updates through digital broadcasts. When a software update is received, you are prompted to update the software. We strongly recommend that you update the software when prompted.

Follow the onscreen instructions.

If you do not update the TV software when the update is received, you are prompted to save the update file. To update the software later:

1. Press **🏠**.
2. Select **[Setup] > [Software settings] > [Local updates]**.
3. Select the file that you downloaded and follow the onscreen instructions to complete the update.

---

## Update from the Internet

You can also update the TV software directly from the Internet by connecting the TV to the Internet. See **Connect your TV > Connect to a Network and the Internet** (Page 57).

1. Press **🏠**.
2. Select **[Setup] > [Update software] > [TV with Internet]**, then press **OK**.
3. Follow the onscreen instructions to start the update.

When the update is complete, the TV switches to standby and on again automatically. Wait for the TV to switch back on. Do not switch the TV on yourself.

### Note:

- If the TV is connected to the Internet, the TV displays the availability of new software at startup.
- Philips may occasionally push a software upgrade to your TV over the Internet. Follow the on-screen instructions to upgrade the TV software.

---

## Reset all

You can reset all picture and sound settings and reinstall all TV channels on your TV.

1. Press **🏠**.
2. Select **[Setup] > [TV settings] > [General settings] > [Reinstall TV]**, then press **OK**.
3. Follow the onscreen instructions.

# 5 Connect your TV

## About cables

### Cable quality

Before you connect devices to the TV, check the available connectors on the device. Connect the device to the TV with the highest quality connection available. Good quality connectors transfer picture and sound better.

The connections shown in this user manual are recommendations only. Other solutions are possible. For more examples, visit <http://www.connectivityguide.philips.com>.

**Tip:** If your device has only composite or RCA connectors, use a composite (CVBS) cable to connect the device to the CVBS/Y connector on the TV.

### HDMI

An HDMI connection has the best picture and sound quality.

- An HDMI cable combines video and audio signals. Connect HDMI for high-definition (HD) TV signals and to switch on EasyLink.
- An HDMI Audio Return Channel (ARC) connector allows output of TV audio to an HDMI ARC compliant device.
- Connect HDMI cables shorter than 5 meters/16.4 feet.

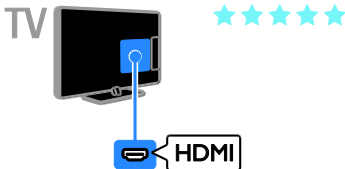

### Y Pb Pr

Component video (Y Pb Pr) only transmits video. For sound, also connect to Audio Left/Right.

- The Y Pb Pr connection can handle high-definition (HD) TV signals.
- Match the Y Pb Pr connector colours to the cable plugs.

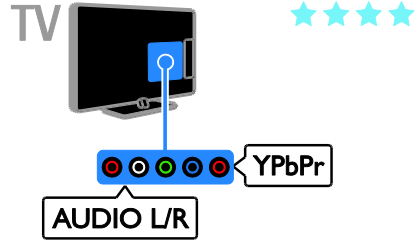

### SCART

A SCART connection combines video and audio signals.

SCART connectors can handle RGB video signals but cannot handle high-definition (HD) TV signals.

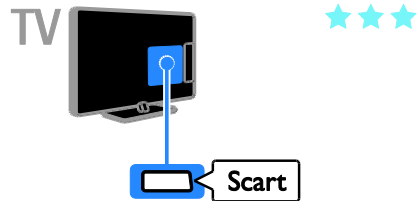

## Connect antenna

Connect the antenna to the TV.

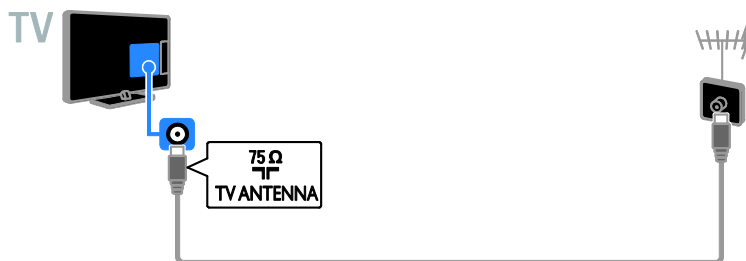

## Connect devices

### Blu-ray or DVD disc player

Connect the disc player to the TV with an HDMI cable.

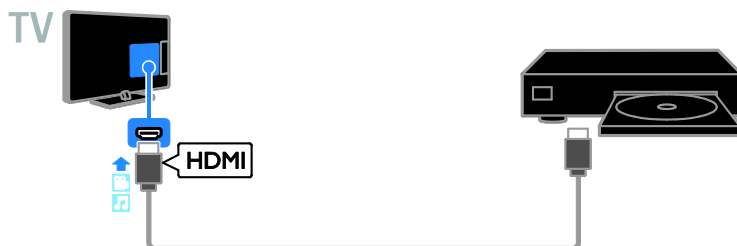

Connect the disc player to the TV with a component video cable (Y Pb Pr) and an audio L/R cable.

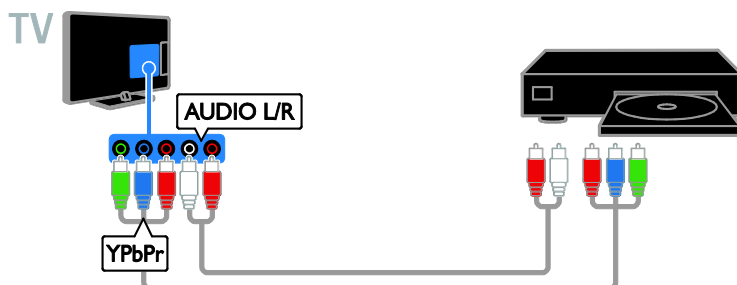

---

## TV receiver

Connect the digital TV receiver with an antenna cable to the TV.

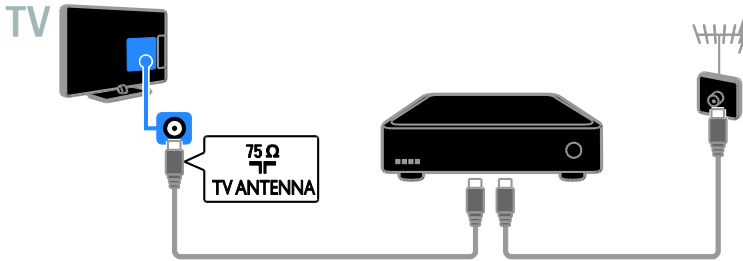

Connect the satellite or digital TV receiver to the TV with an HDMI cable.



Connect the digital TV receiver to the TV with a component video cable (Y Pb Pr) and an audio L/R cable.



Connect the digital TV receiver to the TV with a SCART cable.

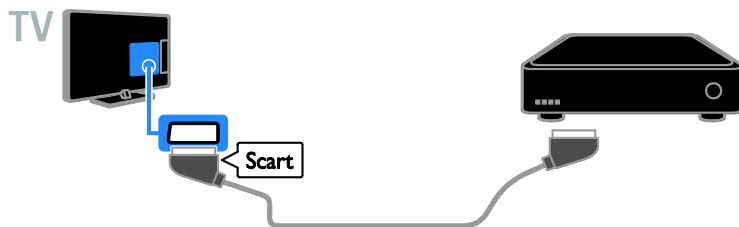

## Video recorder

Connect the recorder to the TV with an antenna cable.

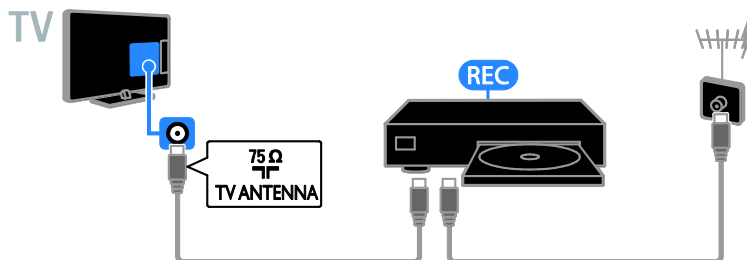

Connect the recorder to the TV with an HDMI cable.

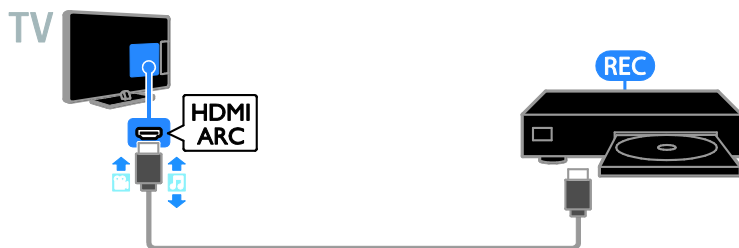

Connect the recorder to the TV with a component video cable (Y Pb Pr) and an audio L/R cable.

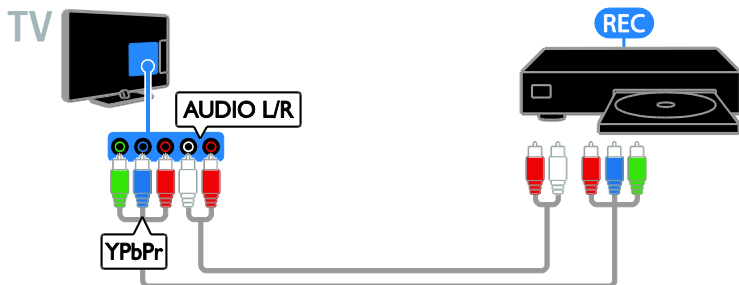

Connect the recorder to the TV with a SCART cable.

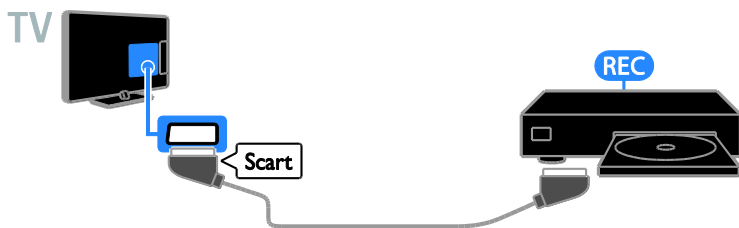

---

## Game console

Connect the game console to the TV with an HDMI cable.





Connect the game console to the TV with a component video cable (Y Pb Pr) and an audio L/R cable.

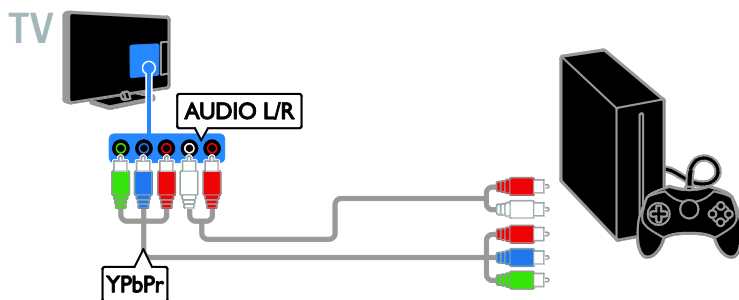

## Home theatre

Connect an HDMI-ARC compliant home theatre to the TV with an HDMI cable.

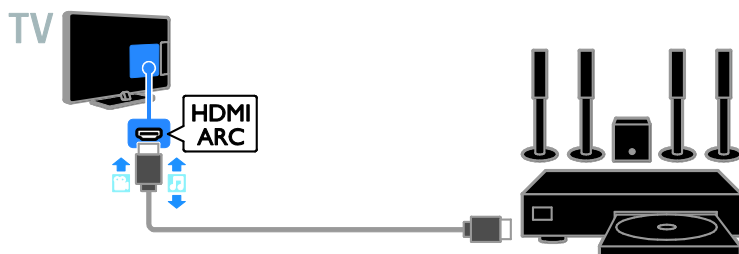

Connect the home theatre to the TV with an HDMI cable and a coaxial audio cable.

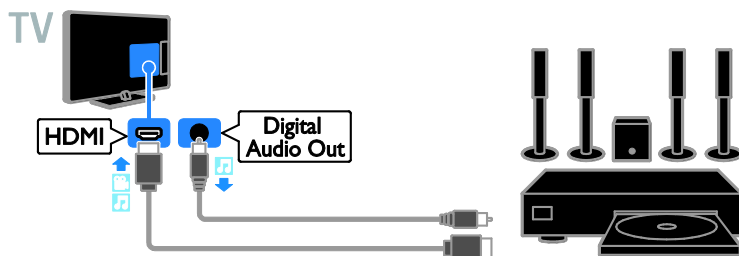

Connect the home theatre to the TV with a component video cable (Y Pb Pr) and an audio L/R cable.

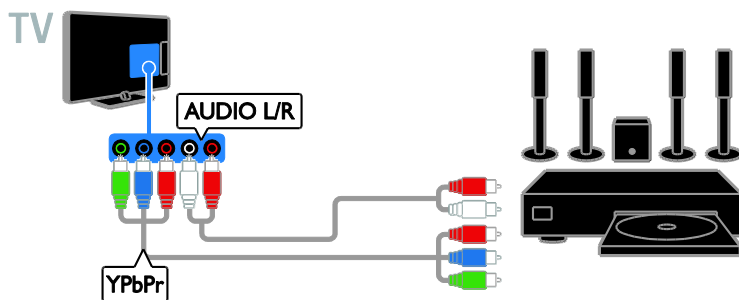

Connect the home theatre to the TV with a SCART cable.

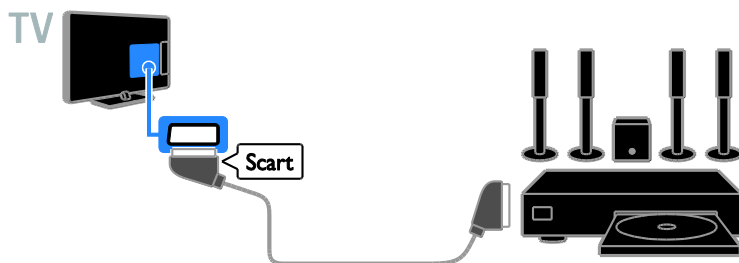

---

## Digital camera

Connect the digital camera to the TV with a USB cable.



## Digital camcorder

Connect the digital camcorder to the TV with an HDMI cable.



Connect the digital camcorder to the TV with a component video cable (Y Pb Pr) and an audio L/R cable.



---

## Connect more devices

---

### USB storage device

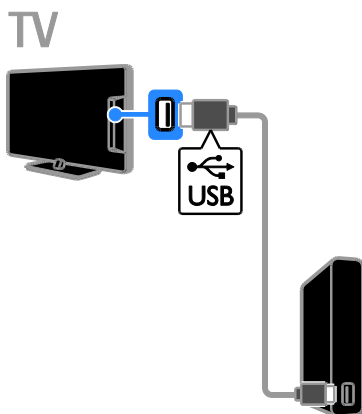

Connect the USB hard drive to the TV with a USB cable.

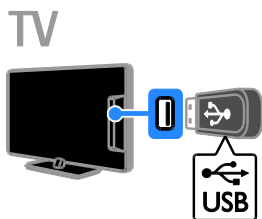

Connect the USB flash drive with a USB cable to the TV.

## Computer

Connect the computer to the TV with an HDMI cable.



Connect the computer to the TV with a DVI-HDMI cable and an audio cable.

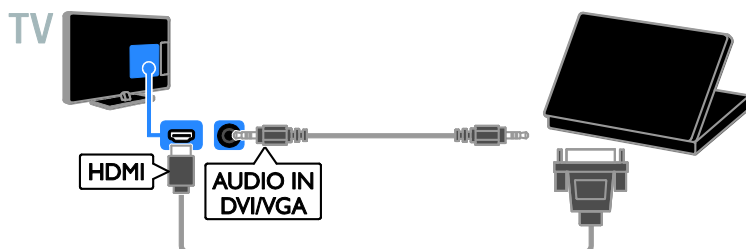

## Video call camera

Connect the Philips TV video camera - PTA317 (sold separately) with a USB cable to the TV.

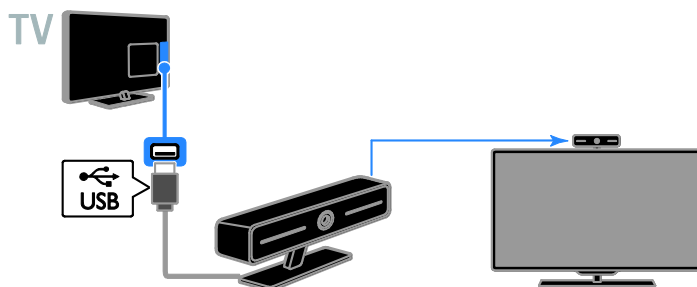

---

## Watch connected devices

---

### Select a device

Before you can watch a device, connect the device to the TV. See **Connect your TV > Connect devices** (Page 45).

#### Select a device with SOURCE

1. Press **SOURCE**.
2. Select a device, then press **OK**.

#### Select a device from Home menu

1. Press **HOME**.
2. Select **[Source]**, then press **OK**.
3. Select a device, then press **OK**.

---

### Update the source list

If you add or remove a device, update the source list.

1. Press **SOURCE**.
2. Press **OPTIONS**.
3. Select **[Scan connections]**, then press **OK**.
4. Follow the onscreen instructions.

---

### Change device settings

#### Change the device type

You can change the device type to easily access it from the Source menu.

1. Press **SOURCE**.
2. Select the device, then press **[Device type]**.
3. Select a suitable device type, then press **OK**.

#### Rename a device

You can rename a device after it is connected to the TV.

1. Press **SOURCE**.
2. Select the connector, then press **[Rename]**.
3. Use the on-screen keypad to enter a new name.
4. When complete, select **[Done]**, then press **OK**.

#### Reset device settings

You can reset the type and name of the device to default settings.

1. In the **[Source]** menu, select the device and press **OPTIONS**.
2. Select **[Original name and icon]**, then press **OK**.

---

## Set up EasyLink devices

---

### What you can do

You can get the most out of your HDMI-CEC-compliant devices with Philips EasyLink enhanced control features. Connect your HDMI-CEC compliant devices through HDMI to your TV and control them at the same time with your TV remote control.

**Note:** Other brands describe HDMI-CEC functionality differently. Some examples are Anynet (Samsung), Aquos Link (Sharp) or BRAVIA Sync (Sony). Not all brands are fully compatible with Philips EasyLink.

After you have switched on Philips EasyLink, the following features are available:

#### One-touch play

When you play an HDMI-CEC compliant device, the TV switches on from standby and switches to the correct source.

#### One-touch standby

When you press **POWER** on the TV remote control, the TV and all HDMI-CEC compliant devices switch to standby mode.

#### Auto switch off inactive devices

If a HDMI-CEC compliant device has been inactive for some time, it switches to standby mode.

#### EasyLink remote control

You can control multiple HDMI-CEC compliant devices with your TV remote control.

## System audio control

If you connect an HDMI-CEC compliant device that includes speakers through the HDMI ARC connector, you can choose to hear the TV audio from those speakers instead of the TV speakers.

## Retain picture quality

If your TV picture quality is affected by the picture-processing features of other devices, you can switch on Pixel Plus Link to retain picture quality.

## Maximise display for subtitled video

Some video subtitles can create a separate subtitle bar under the video, which limits the video display area. To maximise the video display area, you can switch on auto subtitle shift and display the subtitles on the video image.

## What you need

- Connect an HDMI-CEC compliant device to the TV. You can connect more than one HDMI-CEC device. See **Connect your TV > Connect devices** (Page 45).
- Configure each HDMI-CEC compliant device properly.
- Switch on EasyLink.

## Switch on EasyLink

1. Press **⏠**.
2. Select **[Setup] > [TV settings] > [General settings] > [EasyLink]**.
3. Select **[EasyLink] > [On]**, then press **OK**.

## Control devices

If you connect multiple HDMI-CEC devices that support this setting, you can control all such devices through the TV remote control.

**Note:** This is an advanced setting. Devices that do not support this setting cannot respond to the TV remote control.

1. Press **⏠**.
2. Select **[Setup] > [TV settings] > [General settings] > [EasyLink] > [EasyLink remote control]**.
3. Select **[On]** or **[Off]**, then press **OK**.

## Tips:

- To switch back to TV control, press **⏠**, then select **[Watch TV]**.
- To control another device, press **⏠**, then select the device from the Home menu.

## EasyLink buttons

You can control HDMI-CEC compliant devices with the following buttons on the TV remote control:

- **⏏**: Switch the TV and the connected device on or to standby.
- **Play buttons**: Control video or music play.
- **Numeric buttons**: Select a title, chapter or track.
- **OK**: Start, pause or resume play on the connected device, activate a selection, or access the device menu.
- **⏠**: Display the TV Home menu.

## Switch off connecting devices

You can also set the TV to switch off the connecting HDMI-CEC compliant devices if they are not the active source. The TV switches the connecting device to standby after 10 minutes of inactivity.

1. Press **⏠**.
2. Select **[Setup] > [TV settings] > [General settings] > [EasyLink]**.
3. Select **[Auto switch off devices] > [On]**, then press **OK**.

---

## Select speaker output

If a connected device is HDMI Audio Return Channel (HDMI ARC) compliant, you can output TV audio through an HDMI cable. Additional audio cables are not required. Make sure you connect the device to the HDMI ARC connector on the TV. See **Connect your TV > About cables > HDMI** (Page 44).

### Switch on HDMI ARC

1. Press **⬆️**.
2. Select **[Setup] > [TV settings] > [Sound] > [Advanced] > [HDMI 1 - ARC]**.
3. Select one of the following, then press **OK**.
  - **[On]**: Hear the TV audio through the connected HDMI-ARC compliant device.
  - **[Off]**: Hear the TV audio through the TV speakers, or through a device connected through the digital audio out connector.

**Note:** Make sure that all HDMI-CEC settings are properly set up on the connected device.

### Set up TV speakers

1. Press **⬆️**.
2. Select **[Setup] > [TV settings] > [Sound] > [Advanced] > [TV speakers]**.
3. Select an option, then press **OK**:
  - **[Off]**: Switch off TV speakers.
  - **[On]**: Switch on TV speakers.
  - **[EasyLink]**: Switch off TV speakers and stream TV audio to a connected HDMI-CEC audio device.
  - **[EasyLink autostart]**: When a HDMI-CEC audio device is connected, automatically switch off TV speakers and stream TV audio to the device.

## Change TV audio streaming

You can switch audio between TV speakers and a connected amplifier at any time.

1. Press **≡ OPTIONS**.
2. Select **[Picture and sound] > [Speakers]**.
3. Select one of the following, then press **OK**.
  - **[TV]**: On by default.  
Stream TV audio through TV and the connected HDMI-CEC audio device until the connected device switches to system audio control. TV audio is then streamed through the connected device.
  - **[Amplifier]**: Stream audio through the connected HDMI-CEC device. If system audio mode is not enabled on the device, audio continues to stream from the TV speakers. If **[EasyLink autostart]** was selected, the TV prompts the connected device to switch to system audio mode.

---

## Retain picture quality

If your TV picture quality is affected by the picture-processing features of other devices, you can switch on Pixel Plus Link.

### Switch on Pixel Plus Link

1. Press **⬆️**.
2. Select **[Setup] > [TV settings] > [General settings] > [EasyLink]**.
3. Select **[Pixel Plus Link] > [On]**, then press **OK**.

---

## Maximise video display

Some subtitles create a separate subtitle bar under the video that limits the video display area. To maximise the video display area, you can switch on auto subtitle shift. The subtitles are then displayed over the video image.

### Switch on auto subtitle shift

1. Press **⬆️**.
2. Select **[Setup] > [TV settings] > [General settings] > [EasyLink]**.
3. Select **[Auto subtitle shift] > [On]**, then press **OK**.



## Connect to a network and the Internet

### What you can do

#### View Media

If you connect the TV to a home network, you can play photos, music and videos from your computer. See **Use your TV > Play multimedia files** (Page 17).

#### Smart TV

If you connect the TV to a home network with an Internet connection, you can browse Smart TV. Smart TV offers Internet services and websites tailored to your TV. Play music and videos, consult infotainment, rent movies and much more. See **Use your TV > Smart TV** (Page 20).

### What you need

**Warning:** This TV complies with the EMC directive only when you use a shielded Cat5 Ethernet cable.

- A computer network that includes:
  - a) A universal plug-and-play (UPnP) router and
  - b) A computer with one of the following operating systems: Microsoft Windows XP, Microsoft Windows Vista, Mac OS X or Linux.
- To connect your TV to computers, you need to install and configure a media server on your computer. See **Use your TV > Play multimedia files** (Page 17).
- To connect your TV to the Internet, you also need a high-speed connection to the Internet.

### Connect

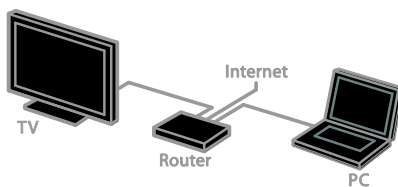

You can connect this TV to your home network through a wired or wireless connection.

- For a wired connection, see **Connect your TV > Connect to a network and the Internet > Wired connection** (Page 58).

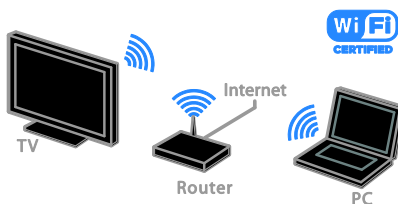

- For PFL42x8, see **Connect your TV > Connect to a network and the Internet > Wi-Fi integrated** (Page 59).

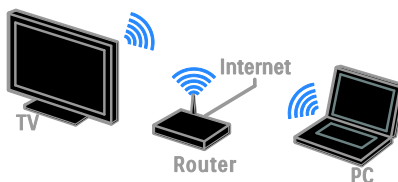

- For PFL32x8, see **Connect your TV > Connect to a network and the Internet > Wi-Fi ready** (Page 58).

---

## Wired connection

1. Switch on the router and switch on its DHCP setting.
2. Connect the router to the TV with an Ethernet cable.
3. Press **⬆**, then select **[Setup]**.
4. Select **[Connect to network]**, then press **OK**.
5. Follow the onscreen instructions to install the network.
6. Wait for the TV to find the network connection.
7. If you are prompted, agree to the End User Licence Agreement.

---

## Wi-Fi ready

This section is for PFL32x8 only.

With the Philips wireless USB adapter PTA128 (sold separately), you can connect the TV to your home network wirelessly.

### Note:

The wireless network operates in the same 2.4GHz frequency spectrum as common household devices, such as Dect phones, microwave ovens or Bluetooth devices, which can cause Wi-Fi interference. Move these devices away from the TV.

- To reduce network traffic, switch off unused network equipment in the home network.
- Reception quality depends on the location of the wireless router and the local Internet service provider.
- When playing video over your wireless home network, we recommend that you use an IEEE 802.11 N router. The connection speed may differ according to the operating environment of your wireless home network.

### Start wireless setup

1. Switch on your wireless network router.
2. Connect the Philips USB adapter PTA128 to a USB connector on the TV. The wireless installation starts automatically.
3. Follow the onscreen instructions.

**Tip:** Keep the wireless USB adapter connected to the TV.

## WPS - Wi-Fi Protected Setup

1. If your router supports Wi-Fi Protected Setup (WPS), press the WPS button on the router.
2. After 2 minutes, select **[WPS]** on the TV, then press **OK**.

The TV connects to your network. This takes about 2 minutes.

Most new wireless routers have the WPS system and carry the WPS logo. The WPS system uses WPS security encryption and cannot be combined with devices on your network that use the WEP security encryption. If you still need the WEP (Wired Equivalent Privacy) devices in your network, install with **[Scan]** > **[Custom]**.

### Scan for routers

If you have several routers in your network, you can select the network you need.

1. To select a specific network router, press **[Scan]** on the first page of the installation. The routers with WPS and the strongest signal are shown first in the list on screen.
2. Select the router you need, then press **OK**.

- If you are connecting to a WPS router, select **[WPS]** on the TV.
- If you want to set the PIN code in your router software to connect, select **[WPS pin]** and note down the code.
- To enter the encryption key manually, select **[Standard]**, then enter the key when prompted.

### Set secured connection with WPS PIN

1. To set secured connection, select the **[WPS pin]** and press **OK**.
2. Write down the 8-digit PIN code shown on TV, then enter it into the router software on your PC.

To find out where to enter the PIN code, read the router manual.

## Set secured connection with WPA encryption

If you have WPA security on your router, enter the pass phrase with the remote control.

1. To enter the encryption key (the security key) manually, select **[Standard]**, then press **OK**.
2. To access the onscreen keyboard, select the text entry field, then press **OK**.

## Set secured connection with WEP encryption

If you have WEP security encryption, the TV asks for the WEP encryption key in hexadecimal numbers.

1. Locate the hexadecimal key in the router software on your PC and make a note of the first key in the WEP keys list.
2. Enter it on TV with the remote control. If the security key is accepted, the TV is connected with the wireless router.
3. If prompted, agree to the End User Licence Agreement.

---

## WiFi integrated

### This section is for PFL42x8 TVs only.

You can connect your TV to your home network wirelessly.

#### Note:

The wireless network operates in the same 2.4 GHz frequency spectrum as common household devices, such as Dect phones, microwave ovens or Bluetooth devices, which can cause WiFi interference. Move these devices away from the TV.

- For optimum WiFi performance, place the TV at a distance of less than 10 m from the wireless router. Avoid obstructions such as concrete walls between the router and the TV.
- Reception quality depends on the location of the wireless router and your local Internet service provider.
- To reduce network traffic, switch off unused network equipment in the home network.

- When playing video over your wireless home network, we recommend that you use an IEEE 802.11 N router. The connection speed may differ according to the operating environment of your wireless home network.

## Start wireless setup

1. Switch on your wireless network router.
2. Press **⬆** on the TV remote control.
3. Select **[Setup]** > **[Connect to network]**, then press **OK**.
4. Follow the onscreen instructions.

## WPS - Wi-Fi Protected Setup

1. If your router supports Wi-Fi Protected Setup (WPS), press the WPS button on the router.
2. After 2 minutes, select **[WPS]** on the TV, then press **OK**.

The TV connects to your network. This takes about 2 minutes.

Most new wireless routers have the WPS system and carry the WPS logo. The WPS system uses WPS security encryption and cannot be combined with devices on your network that use the WEP (Wired Equivalent Privacy) security encryption.

If you still need the WEP devices in your network, install with **[Scan]** > **[Custom]**.

## Scan for routers

If you have several routers in your network, you can select the network you need.

1. To select a specific network router, press **[Scan]** on the first page of the installation. The routers with WPS and the strongest signal are shown first in the list on screen.
2. Select the router you need, then press **OK**.

- If you are connecting to a WPS router, select **[WPS]** on the TV.
- If you want to set the PIN code in your router software to connect, select **[WPS pin]** and note down the code.
- To enter the encryption key manually, select **[Standard]** and enter the key when prompted.

### Set secured connection with WPS encryption

1. To set the secured connection with a PIN code, select the **[WPS pin]** and press **OK**.
2. Write down the 8-digit PIN code shown on TV and enter it in the router software on your PC.  
See the router manual for where to enter the PIN code.

### Set secured connection with WPA encryption

If your router has Wi-Fi Protected Access (WPA) security, enter the pass phrase with the remote control.

1. To enter the encryption key manually, select **[Standard]** and press **OK**.
2. To access the onscreen keyboard, select the text entry field, then press **OK**.

### Set secured connection with WEP encryption

If your router has WEP security, the TV asks for the WEP encryption key in hexadecimal numbers.

1. Locate the hexadecimal key in the router software on your PC and make a note of of the first key in the WEP keys list.
2. Enter the security key on the TV with the remote control to connect to the router.
3. If prompted, agree to the End User Licence Agreement.

---

## Network settings

### TV network name

If you have more than one TV in your home network, you can rename this TV to give it a unique name.

1. Press **⬆**.
2. Select **[Setup] > [Network settings] > [TV network name]**, then press **OK**.
3. Use the onscreen keyboard or the remote control keypad to enter the name.

### Switch on Miracast

This TV is a Miracast-certified TV. To seamlessly display content from a Wi-Fi device on your TV, switch on Miracast.

1. Press **⬆**.
2. Select **[Setup] > [Network settings] > [Wi-Fi Miracast]**.
3. Select **[On]**, then press **OK** to enable Miracast.

**Tip:** To clear the history of all Wi-Fi Miracast devices, select **[Setup] > [Network settings] > [Clear Wi-Fi Miracast devices]**.

### Switch on remote recording

This TV supports remote recording scheduled from a Wi-Fi device.

**Note:** If you switch on remote recording, the TV consumes more power in standby.

1. Press **⬆**.
2. Select **[Setup] > [Network settings] > [MyRemote Recording]**.
3. Select **[On]**, then press **OK**.

## Connect a CAM (Conditional Access Module)

### What you can do

You can watch scrambled digital TV channels with a Conditional Access Module (CAM). Once you have inserted the CAM and paid the subscription fees, you can watch the programmes.

This TV supports CI (Common Interface) as well as CI+. CI+ supports premium HD digital programmes with a high level of copy protection.

**Note:** The applications, functions, content and onscreen messages depend on the CAM service provider.

### What you need

**Caution:** To protect the CAM from damage, insert the CAM as instructed.

**Note:** Refer to the documentation from your service operator on how to insert a smart card into the Conditional Access Module.

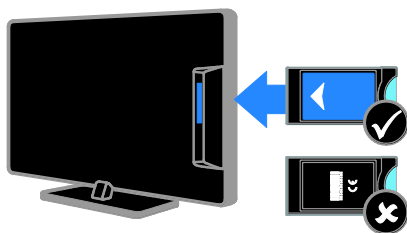

1. Switch off the TV.
2. Follow the directions printed on the CAM to insert the CAM into the Common Interface slot at the side of the TV. Push the CAM in as far as it will go.
3. Switch on the TV, then wait for the CAM to be activated. This takes a few minutes. To maintain access to encrypted digital TV channels, leave the CAM in the slot.

## Access CAM services

1. After you insert and activate the CAM, press **III** **OPTIONS**.
2. Select **[Common interface]**, then press **OK**.
3. Select the CAM provider, then press **OK**.

# 6 Troubleshooting

## General issues

### The TV does not switch on:

- Disconnect the power cable from the power outlet. Wait for one minute then reconnect it.
- Make sure that the power cable is securely connected.

### When you are turning the TV on, off or to standby, you hear a creaking sound from the TV chassis:

No action is required. The creaking sound is due to the normal expansion and contraction of the TV as it cools and warms up. This does not affect performance.

### The TV does not respond to remote control or TV controls when switched on:

The TV requires some time to start up. During this time, the TV does not respond to the remote control or TV controls. This is normal behaviour.

If the TV continues to be unresponsive to the remote control, view the remote control sensor through a digital camera – if you press any button on the remote control and notice red flickering at the sensor, the remote control is working but the TV may need to be checked by Philips Consumer Care. This troubleshooting procedure is not applicable to remote controls that are paired wirelessly with the TV.

### When the TV is in standby, a start-up splash screen is displayed, then the TV returns to standby mode:



This is normal behaviour. When the TV is disconnected and reconnected to the power supply, the startup screen is displayed at the next startup.

To switch on the TV from standby, press  on the remote control or press any key on the TV.

### The standby light on the TV blinks red:

Disconnect the power cable from the power outlet. Wait until the TV cools down before you reconnect the power cable. If the blinking reoccurs, contact Philips Consumer Care.

### The TV audio is in the wrong language:

If you select audio language via  **OPTIONS**, the TV resets to the default language when you change channels or switch off the TV. To retain the selected language, change your audio language by pressing , then selecting **[Setup]** > **[Channel settings]** or **[Satellite settings]** > **[Languages]** > **[Primary audio language]** or **[Secondary audio language]**.

### The TV or Smart TV menu is in the wrong language:

Change the menu to your preferred language.

For more information, see **Change your TV settings > Language settings > Menu language** (Page 40).

### You forgot the 4-digit code to unlock the channel blocking feature (child lock):

Enter '8888'.

### You want to upgrade your TV software:

Visit [www.philips.com/support](http://www.philips.com/support) and download the latest software package for your TV. Software installation instructions and release notes indicating what's been updated are also available at the site. Full instructions on how to upgrade your TV software are also available at **Change your TV settings > Update software** (Page 42).

---

## Channel issues

### You want to install TV channels:

See **Change your TV settings > Automatic installation** (Page 36) for instructions on installing analogue or digital channels. If you want to install satellite TV channels, see **Change your TV settings > Satellite settings** (Page 39).

### No digital channels were found during the installation:

- See the technical specifications to make sure that your TV supports DVB-T, DVB-C or DVB-S in your country.
- Make sure that all cables are properly connected and that the correct network is selected.

### Previously installed channels do not appear in the channel list:

Make sure that the correct channel list is selected.

### You want to rearrange or reorder the channel list:

After channels have been installed, they appear in the channel list. For information about managing channel lists, including rearranging channels, see **Watch TV > Manage channel lists** (Page 13).

---

## Picture issues

### The TV is on, but there is no picture or the picture is distorted:

- Make sure that the antenna is properly connected to the TV.
- Make sure that the correct device is selected as the display source.
- Make sure that the external device or source is properly connected.

### There is sound but no picture:

Make sure that the picture settings are set correctly.

### There is poor TV reception from an antenna connection:

- Make sure that the antenna is properly connected to the TV.
- Loud speakers, unearthed audio devices, neon lights, high buildings and other large objects can influence reception quality. If possible, try to improve the reception quality by changing the antenna direction or moving devices away from the TV.
- If reception on only one channel is poor, fine-tune this channel.

### There is poor picture quality from connected devices:

- Make sure that the devices are connected properly.
- Make sure that the picture settings are set correctly.

### The TV did not save your picture settings:

Make sure that the TV location is set to **Home**. You can change and save settings in this mode.

### The picture does not fit the screen; it is too big or too small:

Change to a different picture format.

### The picture format keeps changing with different channels:

Instead of the picture format **[Auto zoom]**, select a different picture format.

### The picture position is incorrect:

Picture signals from some devices may not fit the screen correctly. Check the signal output of the device.

### The picture from broadcasts is scrambled:

You may need a Conditional Access Module to access content. Check with your service operator.

### An "e-sticker" banner displaying information appears on the TV display:

The TV is in **[Shop]** mode. To remove the e-sticker, set the TV to **[Home]** mode, then restart the TV. See **Change your TV settings > Other settings > Home mode** (Page 42).

The computer display on the TV is not stable:

- Make sure that your PC uses the supported resolution and refresh rate. See **Specifications > Display resolutions** (Page 66).
- Change the TV picture format to **[Unscaled]**.

---

## Sound issues

**There is a picture but sound quality is poor:**

If no audio signal is detected, the TV automatically switches the audio output off — this does not indicate malfunction.

- Make sure that all cables are properly connected.
- Make sure that the volume is not muted or set to zero.
- Make sure that the TV speaker setting is selected. Press **III OPTIONS**, select **[Picture and sound] > [Speakers]**, then select **[TV]**.
- Make sure that the TV audio output is connected to the audio input on the HDMI-CEC enabled or EasyLink compliant home theatre device. Sound should be heard from the home theatre speakers.
- Some devices may require you to manually enable HDMI audio output. If HDMI audio is already enabled, but you still do not hear audio, try changing the digital audio format of the device to PCM (Pulse Code Modulation). Refer to the documentation accompanying your device for instructions.

**There is a picture but the sound quality is poor:**

Make sure that the sound settings are correctly set.

---

## Connection issues

**There are problems with HDMI devices:**

- Note that HDCP (High-bandwidth Digital Content Protection) support can delay the time taken for a TV to display content from an HDMI device.
- If the TV does not recognise the HDMI device and no picture is displayed, switch the source from one device to another and back again.
- If there are intermittent sound disruptions, make sure that output settings from the HDMI device are correct.
- If you use an HDMI-to-DVI adapter or HDMI to DVI cable, make sure that an additional audio cable is connected to **AUDIO L/R** or **AUDIO IN** (mini-jack only).

**You cannot use EasyLink features:**

Make sure that your HDMI devices are HDMI-CEC compatible. EasyLink features only work with devices that are HDMI-CEC compatible.

**If an HDMI-CEC compliant audio device is connected to the TV and the TV does not display any mute or volume icon when the volume is muted, increased or decreased:**

When a HDMI-CEC audio device is connected this behaviour is normal.

**USB device content is not displayed:**

- Make sure that the USB storage device is set to **Mass Storage Class** compliant, as described in the storage device's documentation.
- Make sure that the USB storage device is compatible with the TV.
- Make sure that the audio and picture file formats are supported by the TV.

**Audio and picture files on your USB storage device do not play or display smoothly:**

The transfer performance of the USB storage device may limit the data transfer rate to the TV which causes poor playback.



---

## Network issues

You want to establish a wireless connection between your TV and home network:

- For PFL42x8, refer to **Connect your TV > Connect to a network and the Internet > Wi-Fi integrated** (Page 59) for instructions on how to connect your TV wirelessly to your home network.  
For PFL32x8, refer to **Connect your TV > Connect to a network and the Internet > Wi-Fi Ready** (Page 58) for instructions on how to connect your TV wirelessly to your home network.

**Smart TV does not work:**

Check that the router is properly connected to the TV and that your router has open access to the Internet. If your router has a firewall or security settings, make sure that it allows Smart TV data to pass through – check your router documentation for details.

**Internet access via Smart TV is slow:**

- Try to improve the signal quality between the router and TV if you are accessing the Internet wirelessly. Refer to the router's documentation for details.
- Always use a fast broadband connection wherever possible.
- Update your TV with the latest software to ensure browsing speed is optimal.

**Your network is slow:**

If you are accessing your PC wirelessly, refer to the router's documentation to improve the signal quality between the router and TV.

**Wireless network is distorted or not found:**

- Make sure that the wireless network is not disturbed by microwave ovens, DECT phones or other neighbouring Wi-Fi devices.
- If the wireless network is not working, try a wired network connection.
- Make sure that the firewalls in your network allow access to the TV wireless connection.

---

## Contact Philips

**Warning: Do not attempt to repair the TV yourself. This may cause severe injury, irreparable damage to your TV or void your warranty.**

If are not able to resolve your problem, refer to the frequently asked questions (FAQs) for this TV at [www.philips.com/support](http://www.philips.com/support). You can also consult and contribute to the Philips TV community at [www.supportforum.philips.com](http://www.supportforum.philips.com).

If you wish to speak to or email a Philips representative, contact the Philips Consumer Care in your country. You can find the contact details in the leaflet accompanying this TV or at [www.philips.com/support](http://www.philips.com/support).

Note your TV model and serial number before you contact Philips. These numbers are printed on the back of the TV and on the packaging.

# 7 Specifications

---

## Power and reception

Product specifications are subject to change without notice.

### Power

- Mains power: AC 220-240 V (50-60 Hz)
- Standby power consumption: < 0.3 W
- Ambient temperature: 5 to 40 degree Celsius
- For power consumption, see the product specifications at [www.philips.com/support](http://www.philips.com/support).

The power rating stated on the product typeplate is the power consumption for this product during normal household use (IEC 62087 Ed.2). The maximum power rating, stated between brackets, is used for electrical safety (IEC 60065 Ed. 7.2).

### Reception

- Antenna input: 75 ohm coaxial (IEC75)
- TV system: DVB COFDM 2K/8 K
- Video playback: NTSC, PAL, SECAM\*
- Digital TV: MPEG-4, DVB-T (Terrestrial), DVB-T2\*, DVB-C (Cable), DVB-S/S2\* (Satellite)
- Tuner bands: VHF, UHF, S-Channel, Hyperband

\*Available on certain models only.

---

## Display and sound

### Picture/Display

- Display type: LED backlight HD/Full HD
- Diagonal size:
  - 81 cm / 32 inches
  - 99 cm / 39 inches
  - 102 cm / 40 inches
  - 107 cm / 42 inches
  - 117 cm / 46 inches
  - 127 cm / 50 inches
  - 140 cm / 55 inches

- Aspect ratio: 16:9 (widescreen)
- Panel resolution:
  - Full HD: 1920x1080p
  - HD: 1366 x 768
- Picture enhancement: Digital Crystal Clear
- Perfect Motion Rate (PMR):
  - PFL42x8: 200 Hz
  - PFL32x8: 100 Hz

### Sound

- Output power (RMS): 20 W @ 10% THD
- Clear Sound
- Mono / Stereo / Secondary audio programming

---

## Display resolutions

### Computer formats - HDMI (Resolution - refresh rate)

640 × 480 - 60 Hz  
800 × 600 - 60 Hz  
1024 × 768 - 60 Hz  
1280 × 720 - 60 Hz  
1280 × 768 - 60 Hz  
1280 × 1024 - 60 Hz  
1360 × 768 - 60 Hz

For Full HD TV only:  
1680 × 1050 - 60 Hz  
1920 × 1080 - 60 Hz

### Video formats (Resolution - refresh rate)

480i - 60 Hz  
480p - 60 Hz  
576i - 50 Hz  
576p - 50 Hz  
720p - 50Hz, 60 Hz  
1080i - 50Hz, 60 Hz  
1080p - 24Hz, 25Hz, 30Hz, 50Hz, 60 Hz

## Multimedia

**Note:** Multimedia file names must not exceed 128 characters.

### Supported multimedia connections

- USB: Connect only those USB devices that consume 500 mA of power or less.
  - NTFS, FAT 16 (Read only)
  - FAT 32
- Ethernet LAN RJ-45

### Supported image files

- JPEG: \*.jpg, \*.jpeg, \*.mpo
- GIF (87a, 89a): \*.gif
- PNG: \*.png
- BMP: \*.bmp, \*.dib
- JPS: \*.jps
- PNS: \*.pns
- BMS: \*.bms

### Supported audio/video formats

File Extensions	Container	Video codec	Minimum resolution	Max. Frame Rate (fps)	Max. Bit Rate (Mbps)	Audio codec	USB	Media server	CE-HTML	HTML5	YouTube
.mpg .mpeg .vob	PS	MPEG-1	1920x1080	25p, 30p, 50i, 60i	30	MPEG-1 (L1/L2), MPEG-1,2,2.5 L3, AAC/HE-AAC (v1&v2), DVD-PCM, Dolby Digital	Yes	Yes	Yes	Yes	No
		MPEG-2	1920x1080	25p, 30p, 50i, 60i	30		Yes	Yes	Yes	Yes	No
		MPEG-4 ASP	1920x1080	25p, 30p, 50i, 60i	30		Yes	Yes	Yes	Yes	No
		H.264	1920x1080	25p, 30p, 50i, 60p, 60i	30		Yes	Yes	Yes	Yes	No
.as	TS	MPEG-2	1920x1080	25p, 30p, 50i, 60i	30	MPEG-1 (L1/L2), MPEG-1,2,2.5 L3, AAC/HE-AAC (v1&v2), Dolby Digital, Dolby Digital Plus	Yes	Yes	Yes	Yes	No
		MPEG-4 ASP	1920x1080	25p, 30p, 50i, 60i	30		Yes	Yes	Yes	Yes	No
		H.264	1920x1080	25p, 30p, 50i, 60p, 60i	30		Yes	Yes	Yes	Yes	No
		HVC	1920x1080i @ field rate = 50, 60Hz 1920x1080p @ frame rate = 24, 25, 30Hz 1280x720p @ frame rate = 30, 60Hz	-	30		Yes	Yes	Yes	Yes	No

### Supported audio/video formats

File Extensions	Container	Video codec	Minimum resolution	Max. Frame Rate (fps)	Max. Bit Rate (Mbps)	Audio codec	USB	Media server	CE-HTML	HTML5	YouTube
.as .m2ts .m2ts .m2t	M2TS TTS	MPEG-2	1920x1080	25p, 30p, 50i, 60i	30	MPEG-1 (L1/L2), MPEG-1,2,2.5 L3, AAC/HE-AAC (v1&v2), Dolby Digital, Dolby Digital Plus, Dolby Pulse	Yes	Yes	No	No	No
		MPEG-4 ASP	1920x1080	25p, 30p, 50i, 60i	30		Yes	Yes	No	No	No
		H.264	1920x1080	25p, 30p, 50i, 60p, 60i	30		Yes	Yes	No	No	No
		HVC	1920x1080p @ frame rate = 24, 25, 30Hz 1280x720p @ frame rate = 30, 60Hz	-	30		Yes	Yes	No	No	No
.as .m2ts .m2ts	AVCHD	MPEG-2	1920x1080	25p, 30p, 50i, 60i	30	MPEG-1 (L1/L2), MPEG-1,2,2.5 L3, AAC/HE-AAC (v1&v2), Dolby Digital, Dolby Digital Plus, Dolby Pulse	Yes	Yes	No	No	No
		MPEG-4 ASP	1920x1080	25p, 30p, 50i, 60i	30		Yes	Yes	No	No	No
		H.264	1920x1080	25p, 30p, 50i, 60p, 60i	30		Yes	Yes	No	No	No

### Supported audio/video formats

File Extensions	Container	Video codec	Minimum resolution	Max. Frame Rate (fps)	Max. Bit Rate (Mbps)	Audio codec	USB	Media server	CE-HTML	HTML5	YouTube
.as .m2ts .m2ts	AVCHD	HVC	1920x1080i @ field rate = 50, 60Hz 1920x1080p @ frame rate = 24, 25, 30Hz 1280x720p @ frame rate = 30, 60Hz	-	30	MPEG-1 (L1/L2), MPEG-1,2,2.5 L3, AAC/HE-AAC (v1&v2), Dolby Digital, Dolby Digital Plus, Dolby Pulse	Yes	Yes	No	No	No
		M4V	H.264	1920x1080	25p, 30p, 50i, 60p, 60i		30	AAC	Yes	Yes	Yes
.imz .h264ts .mp4	frag MP4	H.264	1920x1080	25p, 30p, 50i, 60p, 60i	30	AAC/HE-AAC (v1&v2), Dolby Digital, Dolby Digital Plus, WMA, WMA-PRO	No	No	Yes	Yes	Yes
		HVC	1920x1080i @ field rate = 50, 60Hz 1920x1080p @ frame rate = 24, 25, 30Hz 1280x720p @ frame rate = 30, 60Hz	-	30		No	No	Yes	Yes	Yes

## Supported audio/video formats

File Extensions	Container	Video codec	Maximum resolution	Max. Frame Rate (fps)	Max. Bit Rate (Mbps)	Audio codec	USB	Media server	CE-HTML	HTML5	YouTube
.mp4	MP4	MPEG-4 ASP	1920x1088	25p, 30p, 50i, 60i	30	AAC/HE-AAC (V1&V2), Dolby Digital, Dolby Digital Plus, WMA, WMA-PRO	Yes	Yes	Yes	Yes	Yes
		H.264	1920x1088		30		Yes	Yes	Yes	Yes	No
		HVC	1920x1080 @ field rate = 50, 60Hz 1920x1080p @ frame rate = 24, 25, 30Hz 1280x720p @ frame rate = 30, 60Hz	-	30		Yes	Yes	Yes	Yes	No
		WHV9/WC1	1920x1088	30p, 60i	30		Yes	Yes	Yes	Yes	No
.miv .mk3d	MKV	MPEG-4 ASP	1920x1088	25p, 30p, 50i, 60i	30	MPEG-1 (L1&L2), MPEG- 1,2,2.5 L3, AAC/HE-AAC (V1&V2), Dolby Digital, Dolby Digital Plus, WMA, WMA-PRO	Yes	Yes	No	No	No
		H.264	1920x1088		30		Yes	Yes	No	No	No

## Supported audio/video formats

File Extensions	Container	Video codec	Maximum resolution	Max. Frame Rate (fps)	Max. Bit Rate (Mbps)	Audio codec	USB	Media server	CE-HTML	HTML5	YouTube
.asf .wmv	ASF	MPEG-2	1920x1088	25p, 30p, 50i, 60i	20	MPEG-1 (L1&L2), MPEG- 1,2,2.5 L3, AAC/HE-AAC (V1&V2), Dolby Digital Plus, Dolby Digital, WMA, WMA-PRO	Yes	Yes	Yes	Yes	No
		MPEG-4 ASP	1920x1088	25p, 30p, 50i, 60i	20		Yes	Yes	Yes	Yes	No
		WHV9/WC1	1920x1088	30p, 60i	20		Yes	Yes	Yes	Yes	No
.avi .avid	AVI	MPEG-4 ASP	1920x1088	25p, 30p, 50i, 60i	4	MPEG-1 (L1&L2), MPEG- 1,2,2.5 L3, AAC/HE-AAC (V1&V2), Dolby Digital Plus, Dolby Digital, WMA, WMA-PRO	Yes	Yes	No	No	No
		DhX 3.11	1920x1088	30p, 60i	4		Yes	Yes	No	No	No
.webm	WebM	VP8	1920x1088		5	Ogg/Vorbis	Yes	Yes	Yes	Yes	No
.swf	SWF	Container FLV	-	-	30	-	No	No	No	No	Yes
.divx	DHF (DIVX)	MPEG-4 ASP	1920x1088	25p, 30p, 50i, 60i	20	MPEG-1 (L1&L2), MPEG- 1,2,2.5 L3, AAC/HE-AAC (V1&V2), Dolby Digital Plus, Dolby Digital, WMA, WMA-PRO	Yes	No	No	No	No
		DhX 3.11	1920x1088	30p, 60i	20		Yes	No	No	No	No

## Supported audio/video formats

File Extensions	Container	Video codec	Maximum resolution	Max. Frame Rate (fps)	Max. Bit Rate (Mbps)	Audio codec	USB	Media server	CE-HTML	HTML5	YouTube
.3gp .3g2	3GP	MPEG-4 ASP	1920x1088	25p, 30p, 50i, 60i	30	AAC/HE-AAC (V1&V2), AMR	Yes	Yes	No	No	No
		H.264	1920x1088	25p, 30p, 50p, 60p, 60i	30		Yes	Yes	No	No	No
		H.263	1920 x 1088	30p	30		Yes	Yes	No	No	No
.mov .qt	QuickTime	-	-	-	30	-	Yes	Yes	No	No	No

## Supported audio formats

File Extensions	Container	Video codec	Maximum resolution	Frequency (kHz)	Max. Bit Rate (Mbps)	Audio codec	USB	Media server	CE-HTML	HTML5	YouTube
.mp3	MP3	-	-	48	384	MPEG-1,2,2.5 L3	Yes	Yes	Yes	Yes	No
.wma .asf	WMA	-	-	48	192	WMA	Yes	Yes	Yes	Yes	No
.wma	WMA Pro	-	-	96	768	WMA, WMA Pro	Yes	Yes	Yes	Yes	No
.pcm (PC) .pcm (PC)	LPCM	-	-	192	768	LPCM	No	Yes	No	No	No
.wav (PC)	LPCM	-	-	192	768	LPCM	Yes	Yes	No	No	No
.aif (mac) .aiff (mac)	LPCM	-	-	192	768	LPCM	Yes	Yes	No	No	No
.aac .mp4 .m4a	AAC	-	-	48	1024	AAC, HE-AAC (V1&V2)	Yes	Yes	Yes	Yes	No
.pls .m3u	Playlists	-	-	-	-	-	Yes	Yes	No	No	No
.m4a	M4A	-	-	48	1024	AAC, HE-AAC (V1&V2)	Yes	Yes	Yes	Yes	No

## Supported audio formats

File Extensions	Container	Video codec	Minimum resolution	Frequency (Hz)	Max. Bit Rate (Mbps)	Audio codec	USB	Media server	CE-HTML	HTML5	YouTube
.amr	AMR-NB (SmartTV only)	-	-	8 16	12.8 6.6 0.95 12.65 14.25 15.85 18.25 19.85	AMR	Yes	Yes	No	No	No
.ogg .oga	Ogg	-	-	48	498	Ogg/Vorbis	Yes	Yes	No	No	No

## Supported subtitle formats

Format	File Extension	USB	Media Server	CE-HTML	HTML5	YouTube
SRT	.srt	Yes	No	No	No	No
MKV/SRT	-	Yes	Yes	No	No	No
SUB	.sub	Yes	No	No	No	No
TXT	.txt	Yes	Yes	No	No	No
Substation alpha V4	.ass	Yes	Yes	No	No	No
Advanced substation alpha V4+	.ass	Yes	Yes	No	No	No
DVB	-	Yes	Yes	No	No	No
SAMI	.smi .smi	Yes	No	Yes	Yes	No
XSUB, XSUB+	.xsi .xsub	Yes	No	No	No	No
TTML	.ttml	No	No	Yes	Yes	No

## Character encoding

- Windows-1250 (CP-1250): Central Europe and Eastern Europe Latin (Czech, Hungarian, Polish, Slovak, Slovenian, Croatian, Romanian, Serbian)
- Windows-1251 (CP-1251): Cyrillic
- Windows-1252 (CP-1252): Western Europe Latin
- Windows-1253 (CP-1253): Greek
- Windows-1254 (CP-1254): Turkish
- UTF-8: Multi-byte character encoding for Unicode

## Supported DLNA-compliant media server software

- Windows Media Player (Microsoft Windows)
- Twonky Media (Microsoft Windows, Mac OS X)
- Sony Vaio Media Server (Microsoft Windows)
- TVersity (Microsoft Windows)
- Nero MediaHome
- DiXiM (Microsoft Windows XP)
- Macrovision Network Media Server (Microsoft Windows)
- Fuppes (Linux)
- uShare (Linux)

## Connectivity

### Rear

- HDMI 1 ARC: HDMI Audio Return Channel
- For PFL42x8: HDMI 2
- AUDIO IN (DVI): stereo 3.5 mm mini-jack
- NETWORK: Ethernet LAN RJ-45 (for certain models)
- SERV. U: Service port
- CVBS/Y, Pb, Pr, Audio L/R: Composite video and audio
- DIGITAL AUDIO OUT: Coaxial
- TV ANTENNA: 75 ohm coaxial (IEC)
- SCART (RGB/CVBS): SCART adaptor
- SAT: F-pin satellite (for certain models)

### Side

- CI: Common Interface
- HDMI
- USB 2
- USB 1
- Headphones: stereo 3.5mm mini-jack

## Help version

UMv 320812124602 - 20130124

# 8 Index

---

## A

amplifier, select output - 56  
analogue channels, fine-tune - 37  
analogue channels, install - 36  
analogue channels, subtitles - 40  
audio language - 40  
auto subtitle shift - 56  
Auto switch off, devices - 55

---

## C

cables - 44  
CAM - 61  
CAM, enable - 61  
CAM, insert - 61  
channel list - 14  
channel list, copy - 37  
channels - 13  
channels, favourites - 13  
channels, fine-tune (analogue) - 37  
channels, hide or unhide - 14  
channels, install (analogue) - 36  
channels, install (automatic) - 36  
channels, install (digital) - 36  
channels, install (satellite) - 39  
channels, logo - 14  
channels, reinstall - 43  
channels, rename - 14  
channels, sort - 14  
channels, switch - 13  
channels, update - 37  
child lock - 33  
CI - 61  
clock - 32  
codecs, supported - 67  
Common Interface - 61

computer, play files - 17  
Conditional Access Module - 61  
connect, computer - 53  
connect, digital camcorder - 51  
connect, digital camera - 50  
connect, disc player - 45  
connect, external hard disk - 52  
connect, game console - 48  
connect, home network - 57  
connect, home theatre - 49  
connect, Internet - 57  
connect, recorder - 47  
connect, TV receiver - 46  
connect, USB device - 52  
connect, video call camera - 53  
connected device, rename - 54  
connectivity - 69  
connectivity guide - 9  
connectors - 44  
contact Philips - 9  
controls - 10

---

## D

demo - 42  
devices, watch - 54  
digital camcorder - 51  
digital camera - 50  
digital channels, install - 36  
digital channels, subtitles - 40  
digital radio - 14  
disc player, connect - 45  
display resolutions - 66  
display specifications - 66  
DivX VOD - 19  
DLNA - 17  
DVi - 22

---

**E**

EasyLink - 54  
EasyLink, controls - 55  
EasyLink, enable - 55  
EasyLink, features - 54  
EasyLink, onscreen control - 11  
EasyLink, remote control - 55  
EasyLink, TV speakers - 56  
Energy label - 8  
energy-efficient settings - 7  
EPG - 16  
EPG, broadcaster - 16  
EPG, Internet - 16  
external hard disk - 52

---

**F**

favourite channels, list - 13

---

**G**

game console, connect - 48  
game settings - 30

---

**H**

HbbTV - 22  
HDMI - 44  
HDMI ARC - 44  
hearing-impaired access - 41  
help, onscreen - 9  
Help, version - 69  
home mode - 42  
home network - 57  
home theatre, connect - 49

---

**I**

install channels, automatic - 36  
Interactive TV - 22  
Internet, connect - 57  
Internet, Smart TV - 20

---

**K**

Kensington lock - 5  
key beep - 41

---

**L**

language, menu - 40  
language, subtitles - 40  
lock TV - 5

---

**M**

media server program - 17  
mode, home or shop - 42  
Multimedia Home Platform (MHP) - 22  
multimedia, play files - 17  
multimedia, play options - 18  
multimedia, supported formats - 67

---

**N**

network settings - 60  
network, connect - 57  
network, TV name - 60

---

**O**

online forum - 9  
online video, rent - 21

---

**P**

parental rating - 33  
pause TV - 23  
pause TV, USB hard drive - 23

PC, display resolutions - 66  
Philips video camera - 53  
picture format - 15  
picture settings - 34  
picture settings, reset - 35  
Pixel Plus link - 56  
placement, stand or wall - 4  
placement, tips - 4  
play, computer files - 17  
play, USB files - 18  
power specifications - 66  
presets, picture and sound - 15  
product support - 9  
programme guide - 16  
programme guide, broadcaster - 16  
programme guide, Internet - 16

---

## R

rear controls - 10  
record TV, one-touch - 25  
record TV, USB hard drive - 24  
record, TV programmes - 24  
recorder, connect - 47  
recordings, delete - 26  
recordings, schedule - 25  
recordings, watch - 26  
recycle - 8  
reinstall - 43  
remote control - 11  
rename channels - 14  
rename, connected device - 54  
rent, online video - 21

---

## S

safety - 3  
satellite, add or remove - 39  
satellite, install channels - 39  
satellite, settings - 39  
SCART - 44  
schedule, recordings - 25  
screen care - 4  
sensors - 10  
settings assistant - 34  
settings, audio format - 35  
settings, game - 30  
settings, network - 60  
settings, picture - 34  
settings, sound - 35  
shop mode - 42  
Skype - 27  
Skype, block contact - 28  
Skype, contacts - 28  
Skype, receive call - 28  
Skype, settings - 30  
Skype, setup - 27  
Skype, sign in - 27  
Skype, video call - 28  
Skype, voice call - 28  
Skype, voicemails - 30  
sleep timer - 32  
Smart TV - 20  
Smart TV, apps - 21  
Smart TV, browse - 20  
Smart TV, network - 57  
Smart TV, start - 20  
smartphone control - 12  
software, check version - 42  
software, digital update - 43  
software, Internet update - 43  
software, USB update - 42



sound settings - 35  
sound settings, reset - 35  
sound specifications - 66  
source, select - 15  
source, update - 54  
standby - 12  
standby LED - 10  
subtitles, analog - 40  
subtitles, digital - 40  
subtitles, language - 40  
sustainability - 7  
switch TV on, off - 12

---

## T

teletext, search - 31  
text 2.5 - 31  
text, digital text - 31  
text, dual screen - 31  
text, enlarge - 31  
text, language - 31  
text, subpages - 31  
text, Table Of Pages - 31  
trademarks and copyrights - 6  
TV controls - 10  
TV guide - 16  
TV guide, broadcaster - 16  
TV guide, Internet - 16  
TV receiver, connect - 46  
TV speakers, mute - 13

---

## U

universal access, enable - 41  
universal access, hearing impaired - 41  
universal access, visually impaired - 41  
update, source list - 54  
USB, play files - 18

---

## V

video call camera - 53  
video store - 21  
visually impaired access - 41  
volume - 13

---

## W

Wi-Fi integrated, setup - 59  
Wi-Fi ready, setup - 58  
wireless, USB adapter - 58

---

## Y

YouTube - 20  
YPbPr, component video - 44

