



ENGLISH

Easy Setup Guide

Please read this manual carefully before operating your set and retain it for future reference.

ESPAÑOL

Guía Rápida de Configuración

Lea atentamente este manual antes de poner en marcha el equipo y consérvelo para futuras consultas.

LED TV

49LJ5400

49LJ540T

55LJ5400

55LJ540T

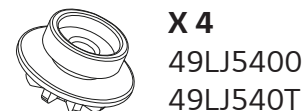
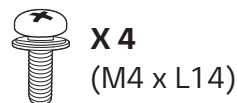
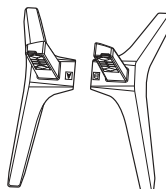
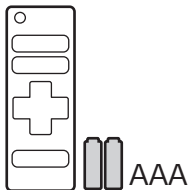
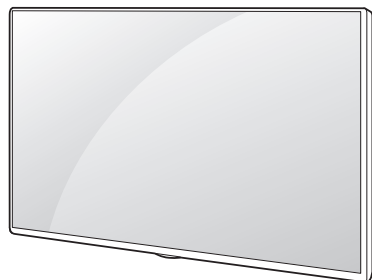

www.lg.com

P/No: MFL70200002 (1706-REV00)





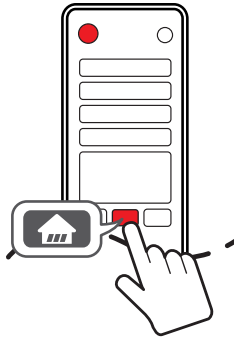

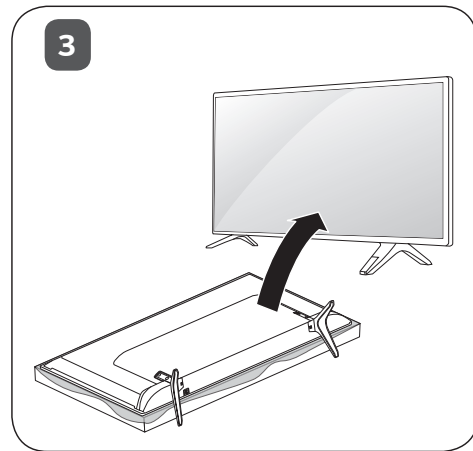
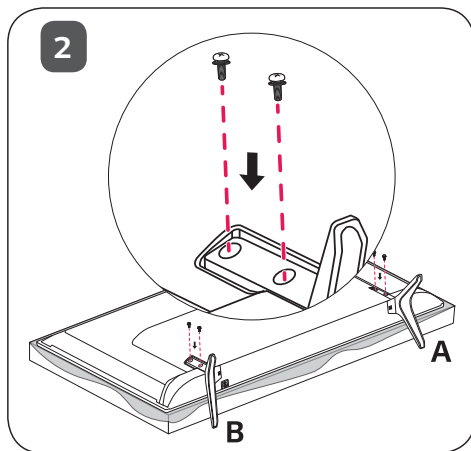
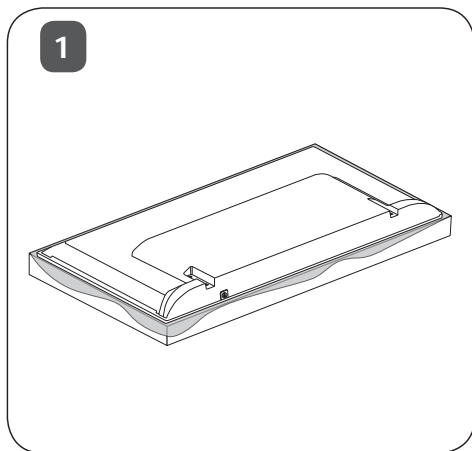

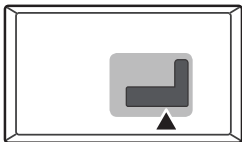













ENGLISH Read **Safety & Reference**.
ESPAÑOL Leer **Seguridad y Consultas**.







<p>ANTENNA IN</p> 	 
<p>CABLE IN</p> 	 
<p>HDMI IN</p> 	 
<p>HDMI IN / ARC</p> 	 
<p>USB IN</p> 	 
<p>LAN</p> 	 
<p>OPTICAL DIGITAL AUDIO OUT</p> 	 

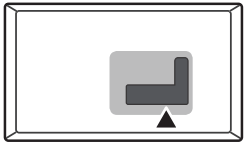

COMPONENT IN

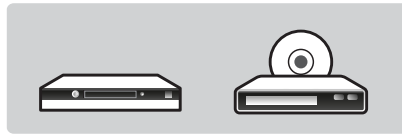
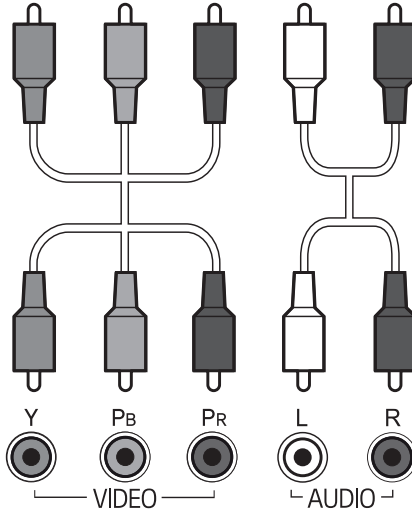
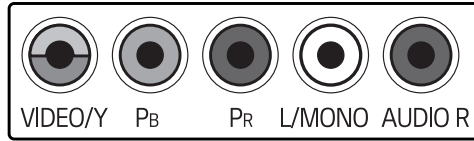

AV IN

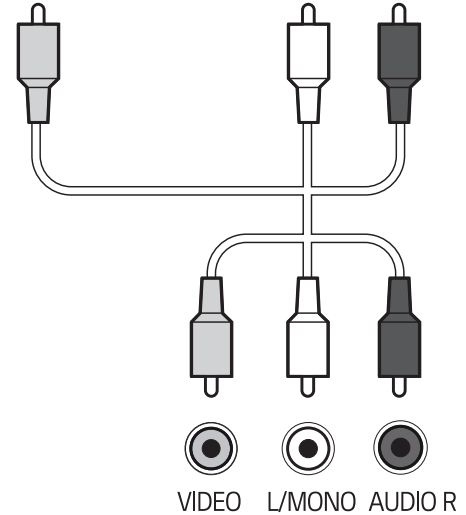
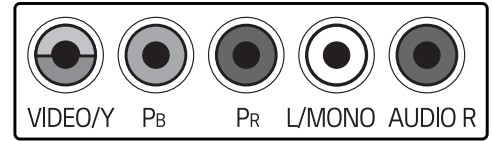

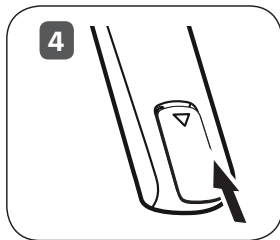
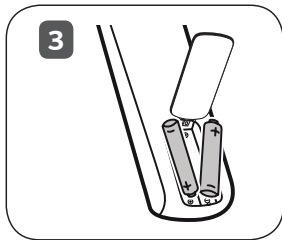
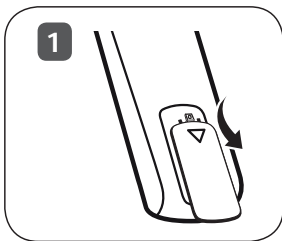
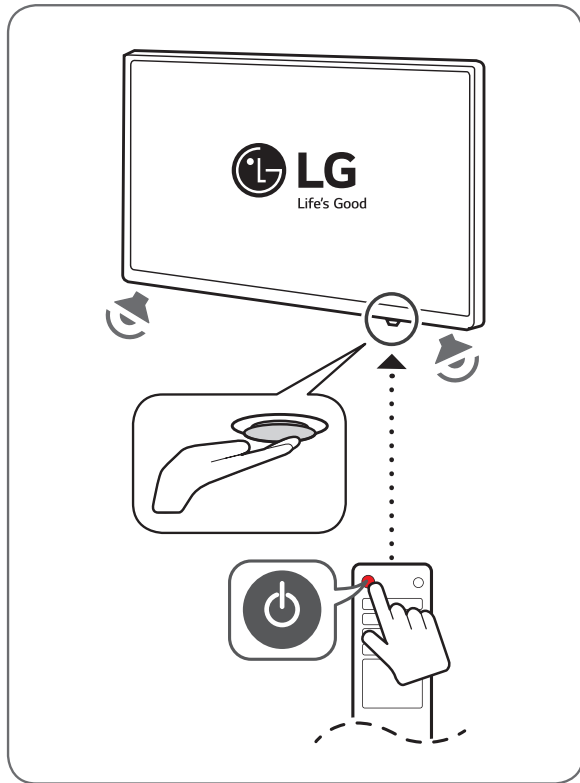
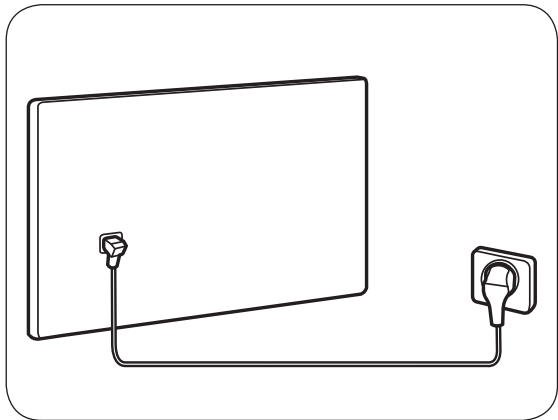

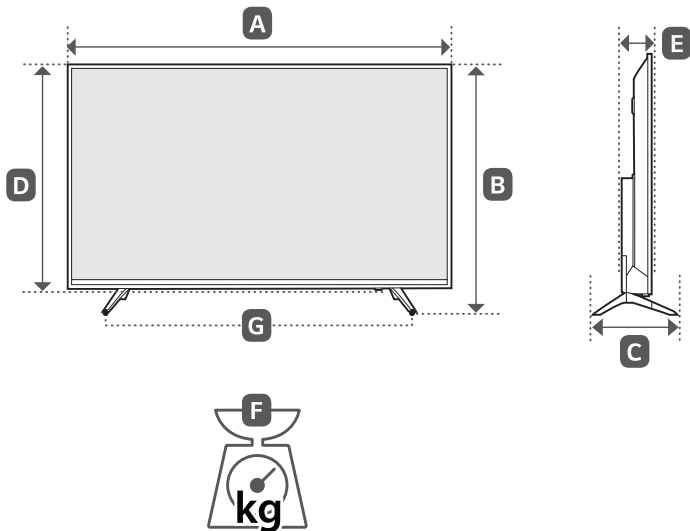

A, B, C, D, E : mm
F, G : kg

MODELS	A		B		C		D		E		F		F - G		Current value / Power consumption	
MODELOS	A		B		C		D		E		F		F - G		Corriente de consumo / Consumo de potencia	
49LJ5400-SA	1,104	1 104	710	710	251.1	251,1	649	649	91.4	91,4	11.3	11,3	11	11	1.5 A / 120 W	1,5 A / 120 W
49LJ540T-DA	1,243	1 243	787	787	251.1	251,1	730	730	91.1	91,1	14	14	13.7	13,7	1.8 A / 150 W	1,8 A / 150 W
55LJ5400-SA	1,243	1 243	787	787	251.1	251,1	730	730	91.1	91,1	14	14	13.7	13,7	1.8 A / 150 W	1,8 A / 150 W
55LJ540T-DA	1,243	1 243	787	787	251.1	251,1	730	730	91.1	91,1	14	14	13.7	13,7	1.8 A / 150 W	1,8 A / 150 W
Power requirement / Alimentación requerida									AC 100 - 240 V ~ 50 / 60 Hz							





OWNER'S MANUAL

Safety and Reference

LED TV*

* LG LED TVs are LCD TVs with LED backlighting.

Please read this manual carefully before operating your TV and retain it for future reference.

49LJ5400
49LJ540T

55LJ5400
55LJ540T



* M F L 7 0 2 4 0 2 0 2 *

www.lg.com

P/NO : MFL70240202 (1706-REV00)

Copyright © 2017 LG Electronics Inc. All Rights Reserved.

Warning! Important Safety instructions

Read these instructions. Keep these instructions. Heed all warnings. Follow all instructions.





CAUTION

RISK OF ELECTRIC SHOCK
DO NOT OPEN



CAUTION : TO REDUCE THE RISK OF ELECTRIC SHOCK DO NOT REMOVE COVER (OR BACK). NO USER SERVICEABLE PARTS INSIDE. REFER TO QUALIFIED SERVICE PERSONNEL.

 The symbol is intended to alert the user to the presence of uninsulated dangerous voltage within the product's enclosure that may be of sufficient magnitude to constitute a risk of electric shock to persons.

 The symbol is intended to alert the user to the presence of important operating and maintenance (servicing) instructions in the literature accompanying the device.

WARNING : TO REDUCE THE RISK OF FIRE AND ELECTRIC SHOCK, DO NOT EXPOSE THIS PRODUCT TO RAIN OR MOISTURE.

ENGLISH

- Do not use this apparatus near water.
- Clean only with dry cloth.
- Do not block any ventilation openings. Install in accordance with the manufacturer's instructions.
- Do not install near any heat sources such as radiators, heat registers, stoves, or other apparatus (including amplifiers) that produce heat.
- Do not defeat the safety purpose of the polarized or grounding-type plug. A polarized plug has two blades with one wider than the other. A grounding type plug has two blades and a third grounding prong. The wide blade or the third prong are provided for your safety. If the provided plug does not fit into your outlet, consult an electrician for replacement of the obsolete outlet.

- Protect the power cord from being walked on or pinched particularly at plugs, convenience receptacles, and the point where they exit from the apparatus.
- Only use attachments/accessories specified by the manufacturer.
- Use only with the cart, stand, tripod, bracket, or table specified by the manufacturer, or sold with the apparatus. When a cart is used, use caution when moving the cart/apparatus combination to avoid injury from tip-over.



SS125A

- Unplug this apparatus during lightning storms or when unused for long periods of time.
- Refer all servicing to qualified service personnel. Servicing is required when the apparatus has been damaged in any way, such as power-supply cord or plug is damaged, liquid has been spilled or objects have fallen into the apparatus, the apparatus has been exposed to rain or moisture, does not operate normally, or has been dropped.
- Do not press strongly upon the panel with a hand or a sharp object such as a nail, pencil, or pen, or make a scratch on it.
- Do not stick metal objects or any other conductive material into the power cord. Do not touch the end of the power cord while it is plugged in.
- Keep the packing anti-moisture material or vinyl packing out of the reach of children. Anti-moisture material is harmful if swallowed. If swallowed, induce vomiting and go to the nearest hospital. Additionally, vinyl packing can cause suffocation. Keep it out of the reach of children.

2

- Concerning the Power Cord (Can differ by country): Check the specification page of this owner's manual to be certain concerning current requirements. Do not connect too many devices to the same AC power outlet as this could result in fire or electric shock. Do not overload wall outlets. Overloaded wall outlets, loose or damaged wall outlets, extension cords, frayed power cords, or damaged or cracked wire insulation are dangerous. Any of these conditions could result in electric shock or fire. Periodically examine the cord of your device, and if its appearance indicates damage or deterioration, unplug it, discontinue use of the device, and have the cord replaced with an exact replacement part by an authorized servicer. Protect the power cord from physical or mechanical abuse, such as being twisted, kinked, pinched, closed in a door, or walked upon. Pay particular attention to plugs, wall outlets, and the point where the cord exits the device. Do not move the TV with the power cord plugged in. Do not use a damaged or loose power cord. Be sure do grasp the plug when unplugging the power cord. Do not pull on the power cord to unplug the TV.
- To reduce the risk of fire or electrical shock, do not expose this product to rain, moisture or other liquids. Do not touch the TV with wet hands. Do not install this product near flammable objects such as gasoline or candles, or expose the TV to direct air conditioning.
- Do not use high voltage electrical equipment near the TV (e.g., a bug zapper). This may result in product malfunction.
- Do not expose to dripping or splashing and do not place objects filled with liquids, such as vases, cups, etc. on or over the apparatus (e.g., on shelves above the unit).
- **Grounding** (Except for devices which are not grounded.) Ensure that you connect the earth ground wire to prevent possible electric shock (i.e., a TV with a three-prong grounded AC plug must be connected to a three-prong grounded AC outlet). If grounding methods are not possible, have a qualified electrician install a separate circuit breaker. Do not try to ground the unit by connecting it to telephone wires, lightning rods, or gas pipes.
- As long as this unit is connected to the AC wall outlet, it is not disconnected from the AC power source even if the unit is turned off.
- Do not attempt to modify this product in any way without written authorization from LG Electronics. Unauthorized modification could void the user's authority to operate this product.
- **Outdoor Antenna Grounding** (Can differ by country): If an outdoor antenna is installed, follow the precautions below. An outdoor antenna system should not be located in the vicinity of overhead power lines or other electric light or power circuits, or where it can come in contact with such power lines or circuits as death or serious injury can occur. Be sure the antenna system is grounded to provide some protection against voltage surges and built-up static charges. Section 810 of the National Electrical Code (NEC) in the U.S.A. provides information with respect to proper grounding of the mast and supporting structure, grounding of the lead-in wire to an antenna discharge unit, size of grounding conductors, location of antenna discharge unit, connection to grounding electrodes and requirements for the grounding electrode. **Antenna grounding according to the National Electrical Code, ANSI/NFPA 70**
- **Moving** Make sure the product is turned off, unplugged, and all cables have been removed. It may take 2 or more people to carry larger TVs. Do not press or put stress on the front panel of the TV.
- **Ventilation** Install your TV where there is proper ventilation. Do not install in a confined space such as a bookcase. Do not cover the product with cloth or other materials while plugged. Do not install in excessively dusty places.
- Take care not to touch the ventilation openings. When watching the TV for a long period, the ventilation openings may become hot. This does not affect the performance of the product or cause defects in the product.
- If you smell smoke or other odors coming from the TV, unplug the power cord and contact an authorized service center.
- If water or another substance enters the product (like an AC adapter, power cord, or TV), disconnect the power cord and contact the service center immediately. Otherwise, this may result in fire or electric shock.

- Do not install this product on a wall if it could be exposed to oil or oil mist. This may damage the product and cause it to fall.
- Use only an authorized AC adapter and power cord approved by LG Electronics. Otherwise, this may result in fire, electric shock, malfunction, or product deformation.
- Never disassemble the AC adapter or power cord. This may result in fire or electric shock.
- Handle the adapter carefully to avoid dropping or striking it. An impact could damage the adapter.
- Keep the product away from direct sunlight.
- Never touch this apparatus or antenna during a lightning storm.
- When mounting a TV on the wall, make sure not to install the TV by hanging the power and signal cables on the back of the TV.
- Do not allow an impact shock, any objects to fall into the product, and do not drop anything onto the screen.
- **DISCONNECTING THE DEVICE FROM THE MAIN POWER** The power plug is the disconnecting device. In case of an emergency, the power plug must remain readily accessible.
- Make sure the power cord is connected securely to the power plug on the TV.
- **Batteries** Store the accessories (battery, etc.) in a safe location out of the reach of children.
- This apparatus uses batteries. In your community there might be regulations that require you to dispose of these batteries properly due to environmental considerations. Please contact your local authorities for disposal or recycling information.
- Do not dispose of batteries in a fire.
- Do not short circuit, disassemble, or allow the batteries to overheat.
- **Cleaning** When cleaning, unplug the power cord and wipe gently with a soft cloth to prevent scratching. Do not spray water or other liquids directly on the TV as electric shock may occur. Do not clean your TV with chemicals including glass cleaner, any type of air freshener, insecticide, lubricants, wax (car, industrial), abrasive, thinner, benzene, alcohol etc., which can damage the product and/ or its panel.

Preparing

- When the TV is turned on for the first time after being shipped from the factory, initialization of the TV may take approximately one minute.
- Image shown may differ from your TV.
- Your TV's OSD (On Screen Display) may differ slightly from that shown in this manual.
- The available menus and options may differ from the input source or product model that you are using.
- New features may be added to this TV in the future.
- The items supplied with your product may vary depending upon the model.
- Product specifications or contents of this manual may be changed without prior notice due to upgrade of product functions.
- For an optimal connection, HDMI cables and USB devices should have bezels less than 10 mm thick and 18 mm width.
- Use an extension cable that supports USB 2.0 if the USB cable or USB flash drive does not fit into your TV's USB port.
- Use a certified cable with the HDMI logo attached. If you do not use a certified HDMI cable, the screen may not display or a connection error may occur.
- Recommended HDMI cable types (3 m or less)
 - High-Speed HDMI®/™ cable
 - High-Speed HDMI®/™ cable with Ethernet

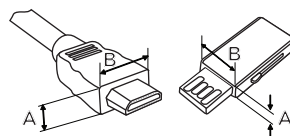

*A ≤ 10 mm

*B ≤ 18 mm

- Do not use any unapproved items to ensure the safety and lifespan of the product.
- Any damages or injuries by using unapproved items are not covered by the warranty.

- Some models appear to have a thin film on the screen. It is actually part of the screen; do not remove it.
- When attaching the stand to the TV set, place the screen facing down on a cushioned table or flat surface to protect the screen from scratches.
- Make sure that the screws are fastened tightly. (If they are not fastened securely enough, the TV may tilt forward after being installed.)
- Do not fasten the screws with excessive force otherwise they may be worn out and become loose.

Lifting and Moving the TV



When moving or lifting the TV, read the following to prevent the TV from being scratched or damaged and for safe transportation regardless of its type and size.

- It is recommended to move the TV in the box or packing material that the TV originally came in.
- Before moving or lifting the TV, disconnect the power cord and all cables.
- When holding the TV, the screen should face away from you to avoid damage.

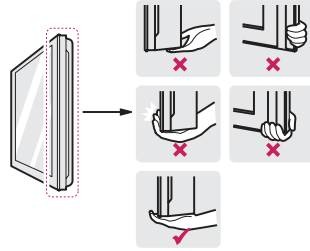

- Hold the top and bottom of the TV frame firmly. Make sure not to hold the transparent part, speaker, or speaker grille area.

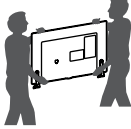

- Use at least two people to move a large TV.
 - When transporting the TV by hand, hold the TV as shown in the following illustration.
- 
- When transporting the TV, do not expose the TV to jolts or excessive vibration.
 - When transporting the TV, keep the TV upright; never turn the TV on its side or tilt towards the left or right.
 - When handling the TV, be careful not to damage the protruding buttons.
-  • Avoid touching the screen at all times, as this may result in damage to the screen.
- Do not place the product on the floor with its front facing down without padding. Failure to do so may result in damage to the screen.
 - Do not move the TV by holding the cable holders, as the cable holders may break, and injuries and damage to the TV may occur. (Depending upon model)

Using the Button

You can operate the TV functions, using the button.

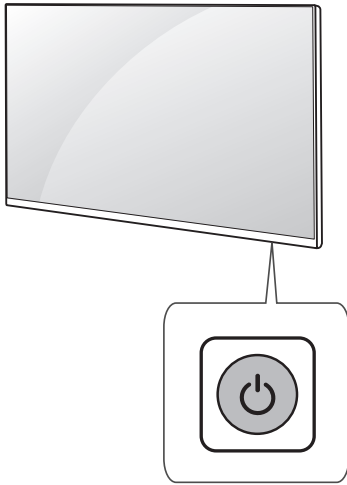

Basic Functions

	Power On (Press)
	Power Off ¹ (Press and Hold)
	Menu control (Press ²)
	Menu selection (Press and Hold ³)

- 1 All running apps will close, and any recording in progress will stop.
- 2 You can access and adjust the menu by pressing the button when TV is on.
- 3 You can use the function when you access menu control.

Adjusting the Menu

When the TV is turned on, press the button one time. You can adjust the Menu items using the button.

	Turns the power off.
	Changes the input source.
	Scrolls through the saved channels.
	Adjusts the volume level.

Mounting on a Table

- 1 Lift and tilt the TV into its upright position on a table.
 - Leave a 10 cm (minimum) space from the wall for proper ventilation.

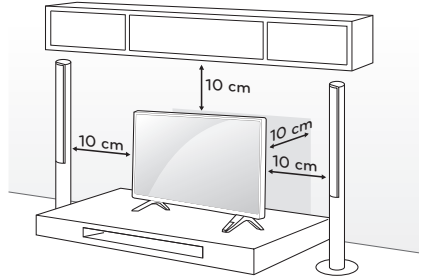

- 2 Connect the power cord to a wall outlet.

- Do not apply foreign substances (oils, lubricants, etc.) to the screw parts when assembling the product. (Doing so may damage the product.)

Securing the TV to a Wall (optional)

(Depending upon model)

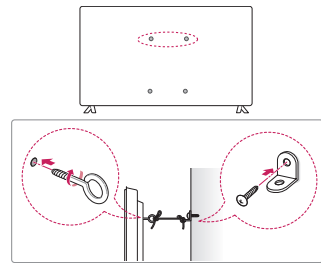

- 1 Insert and tighten the eye-bolts or TV brackets and bolts on the back of the TV.
 - If there are bolts inserted at the eye-bolts position, remove the bolts first.
- 2 Mount the wall brackets with the bolts to the wall. Match the location of the wall bracket and the eye-bolts on the rear of the TV.
- 3 Connect the eye-bolts and wall brackets tightly with a sturdy rope or cable. Make sure to keep the rope parallel to the flat surface.



- Make sure that children do not climb on or hang on the TV.
- Use a platform or cabinet that is strong and large enough to support the TV securely.
- Brackets, bolts, and ropes are optional. You can obtain additional accessories from your local dealer.

Mounting on a Wall

An optional wall mount can be used with your LG Television. Consult with your local dealer for a wall mount that supports the VESA standard used by your TV model. Carefully attach the wall mount bracket at the rear of the TV. Install the wall mount bracket on a solid wall perpendicular to the floor. If you are attaching the TV to other building materials, please contact qualified personnel to install the wall mount. Detailed instructions will be included with the wall mount. We recommend that you use an LG brand wall mount. The LG wall mount is easy to adjust or to connect the cables. When you do not use LG's wall mount bracket, use a wall mount bracket where the device is adequately secured to the wall with enough space to allow connectivity to external devices. If you are using a non-adjustable mount, attach the mount to the wall. Attach the cables to the TV first, then attach the TV to the mount.

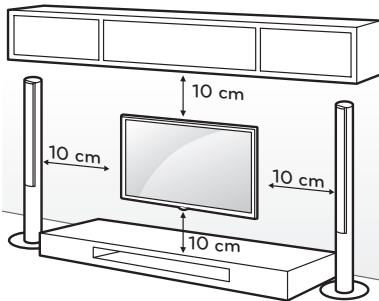

Make sure to use screws and wall mounts that meet the VESA standard. Standard dimensions for the wall mount kits are described in the following table.

Model	49LJ5400 49LJ540T	55LJ5400 55LJ540T
VESA (A x B)	200 x 200	300 x 200
Standard screw	M6	M6
Number of screws	4	4
Wall mount bracket (optional)	LSW240B MSW240	OTW420B

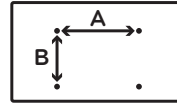

- Remove the stand before installing the TV on a wall mount by performing the stand attachment in reverse.
- When attaching the LG wall mount bracket to the TV, do not use wall mount spacers provided with the LG wall mount bracket. Please use wall mount inner spacers provided with the TV accessory. (For 49LJ5400)

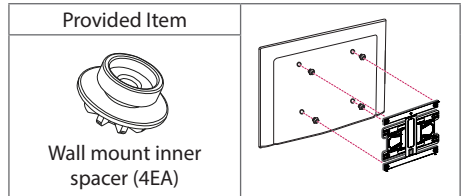

Connections (Notifications)

You can connect various external devices to the TV. Supported external devices are: HD receivers, DVD players, VCRs, audio systems, USB storage devices, PC, gaming devices, and other external devices. For more information on external device's connection, refer to the manual provided with each device.

- If you record a TV program on a DVD recorder or VCR, make sure to connect the TV signal input cable to the TV through a DVD recorder or VCR. For more information about recording, refer to the manual provided with the connected device.
- The external device connections shown may differ slightly from illustrations in a manual.
- Connect external devices to the TV regardless about the order of the TV port.

- If you connect a gaming device to the TV, use the cable supplied with the gaming device.
- Refer to the external equipment's manual for operating instructions.
- In PC mode, there may be noise associated with the resolution, vertical pattern, contrast or brightness. If noise is present, change the PC output to another resolution, change the refresh rate to another rate or adjust the brightness and contrast on the **Picture** menu until the picture is clear.
- When connecting via a wired LAN, it is recommended to use a CAT 7 cable.

Connecting to an Antenna or Cable

Connect an antenna, cable, or cable box to watch TV while referring to the following. The illustrations may differ from the actual items and an RF cable is optional.

- Make sure not to bend the copper wire of the RF cable.

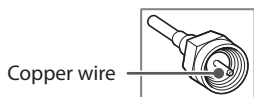

- Complete all connections between devices, and then connect the power cord to the power outlet to prevent damage to your TV.
- To improve the picture quality in a poor signal area, purchase a signal amplifier.
- Use a signal splitter to use 2 TVs or more.
- If the antenna is not installed properly, contact your dealer for assistance.
- DTV Audio Supported Codec (Depending upon country) : MPEG, AAC, HE-AAC, Dolby Digital, Dolby Digital Plus

Other Connections

Connect your TV to external devices. For the best picture and audio quality, connect the external device and the TV with the HDMI cable.

- HDMI Audio Supported Format:
DTS (44.1 kHz / 48 kHz), Dolby Digital / Dolby Digital Plus (32 kHz / 44.1 kHz / 48 kHz), PCM (32 kHz / 44.1 kHz / 48 kHz / 96 kHz / 192 kHz) (Depending upon model)

Remote Control

(Some buttons and services may not be provided depending upon the model or region.)

The descriptions in this manual are based on the buttons on the remote control. Please read this manual carefully and use the TV correctly. To install batteries, open the battery cover, replace batteries (1.5 V AAA) matching the ⊕ and ⊖ ends to the label inside the compartment, and close the battery cover. Failure to match the correct polarities of the batteries may cause the battery to burst or leak, resulting in fire, personal injury, or ambient pollution. To remove the batteries, perform the installation actions in reverse. This remote uses infrared light. When in use, it should be pointed in the direction of the TV's remote sensor.

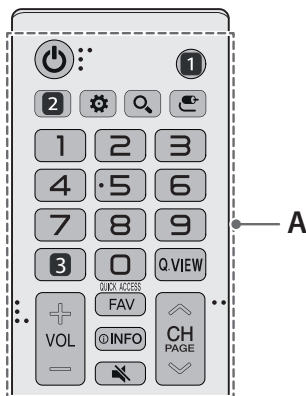

A

- ⏻ (Power) Turns the TV on or off.
- 1 TV Returns to the last TV channel.
TV/RAD Toggles between Radio, TV, CATV, and DTV.
- 2 CAPTION Activates or deactivates the subtitles.
SUBTITLE Activates your preferred subtitle in digital mode.
- ⚙ (Q.Settings) Accesses the Quick Settings.
- 🔍 (Search) Shows the search mode.
- 📺 (Input) Changes the input source.
- Number button Enters numbers.

3 — (Dash) Inserts a dash between numbers such as 2-1 and 2-2.

LIST Accesses the saved channel list.

QUICK ACCESS* You can access the application or Live TV channel by using the number buttons as registered.

Q.VIEW Alternates between the two last channels selected (pressing repeatedly).

+ VOL - Adjusts the volume level.

FAV Accesses your favorite channel list.

ⓘ INFO Shows information on the current program.

🔇 (Mute) Mutes all sounds.

• Pressing and holding the **🔇 (Mute)** button displays the **Accessibility** menu.

^ CH v Scrolls through the saved channels.

^ PAGE v Moves to the previous or next screen.

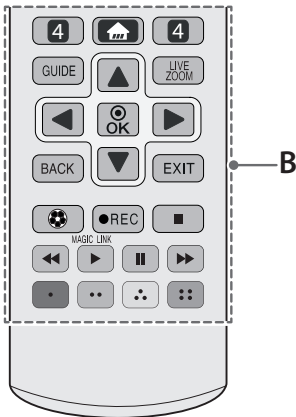

B

4 Streaming Service buttons Connects to the Video Streaming Service.

🏠 (Home) Accesses the Home menu.

• Pressing and holding the **🏠 (Home)** button displays the previous history.

GUIDE Displays the program event according to time scheduler.

LIVE ZOOM Turns the Focus zoom on or off.

Navigation button (up / down / left / right) Scrolls through menus or options.

Ⓞ OK Selects menus or options and confirms your input.

BACK Returns to the previous screen.

EXIT Clears all on-screen displays and returns to TV viewing.

⚙️ Optimizes picture and audio settings for soccer.

● **REC** Starts to record. (Only Time Machine^{Ready} supported model)

■ ◀▶⏸▶▶ Control buttons for media contents

MAGIC LINK* Provides content related to the program you are currently watching.

⏏ ⏏ ⏏ ⏏ These access special functions in some menus.

* : To use the button, press and hold for more than 3 seconds.

External Control Device Setup

To obtain the external control device setup information, please visit www.lg.com.

Open Source Software Notice Information

To obtain the source code under GPL, LGPL, MPL, and other open source licenses, that is contained in this product, please visit <http://opensource.lge.com>. In addition to the source code, all referred license terms, warranty disclaimers and copyright notices are available for download.

LG Electronics will also provide open source code to you on CD-ROM for a charge covering the cost of performing such distribution (such as the cost of media, shipping, and handling) upon email request to opensource@lge.com. This offer is valid for three (3) years from the date on which you purchased the product.

Licenses

Supported licenses may differ by model.
For more information about licenses,
visit www.lg.com.



Troubleshooting

- Cannot control the TV with the remote control.
 - Check if anything such as tape has been placed over the receiver.
 - Check if there is any obstacle between the product and the remote control.
 - Replace the batteries with new fresh ones.
- No image display and no sound is produced.
 - Check if the product is turned on.
 - Check if the power cord is connected to a wall outlet.
 - Check if there is a problem in the wall outlet by connecting other products.
- The TV turns off suddenly.
 - Check the power control settings. The power supply may be interrupted.
 - Check if the **Timer Power Off / Sleep Timer** feature is activated in the **Timers** settings.
 - If there is no signal while the TV is on, the TV will turn off automatically after 15 minutes of inactivity.

• Abnormal Display

- If the TV feels cold to the touch, there may be a small flicker when it is turned on. This is normal; there is nothing wrong with TV. Some minute dot defects may be visible on the screen, appearing as tiny red, green, or blue spots. However, they have no adverse effect on the TV's performance. Avoid touching the LCD screen or holding your finger(s) against it for long periods of time. Doing so may produce some temporary distortion effects on the screen.
- This panel is an advanced product that contains millions of pixels. In a very few cases, you could see fine dots on the screen while you're viewing the TV. Those dots are deactivated pixels and do not affect the performance and reliability of the TV.
- Displaying a still image for a prolonged period of time may cause an image sticking. Avoid displaying a fixed image on the TV screen for a extended length of time.

• Generated Sound

- **Cracking noise** A cracking noise that occurs when watching or turning off the TV is generated by plastic thermal contraction due to temperature and humidity. This noise is common for products where thermal deformation is required.
- **Electrical circuit humming/panel buzzing** A low level noise is generated from a high-speed switching circuit, which supplies a large amount of current to operate a product. It varies depending upon the product. This generated sound does not affect the performance and reliability of the product.

Specifications

Product specifications may be changed without prior notice due to upgrade of product functions.

The energy information provided on the product is shown in accordance with the applicable regulations of each respective country (Depending upon the country).

- The Energy consumption was measured in accordance with IEC 62087.

The actual energy consumption depends on the usage environment (The content watched, TV settings, etc.).

Television System

For LJ5400-S* series	NTSC, PAL-M/N, SBTVD
For LJ540T-D* series	NTSC, PAL-M/N, DVB-T, DVB-T2

Program Coverage

For LJ5400-S* series	VHF 2-13, UHF 14-69, DTV 2-69, CATV 1-135
For LJ540T-D* series	VHF 2-13, UHF 14-69, DTV 2-69, CATV 1-125

External Antenna Impedance

75 Ω

Environment condition

- **Operating Temperature**
0 °C to 40 °C
- **Operating Humidity**
Less than 80 %
- **Storage Temperature**
-20 °C to 60 °C
- **Storage Humidity**
Less than 85 %

Wireless Module (LGSWFAC71) Specifications

Wireless LAN (IEEE 802.11a/b/g/n/ac)	
Frequency Range	Output Power (Max.)
2400 to 2483.5 MHz	15 dBm
5150 to 5725 MHz	14.5 dBm
5725 to 5850 MHz	14.5 dBm

- As band channels can vary per country, the user cannot change or adjust the operating frequency. This product is configured for the regional frequency table.
- For consideration of the user, this device should be installed and operated with a minimum distance of 20 cm between the device and the body.
- FCC ID: BEJLGSWFAC71 / IC: 2703H-LGSWFAC71

Regulatory







WARNING!

Never place a television set in an unstable location. A television set may fall, causing serious personal injury or death. Many injuries, particularly to children, can be avoided by taking simple precautions such as:

- Using cabinets or stands recommended by the manufacturer of the television set.
- Only using furniture that can safely support the television set.
- Ensuring the television set is not overhanging the edge of the supporting furniture.
- Not placing the television set on tall furniture (for example, cupboards or bookcases) without anchoring both the furniture and the television set to a suitable support.
- Not placing the television set on cloth or other materials that may be located between the television set and supporting furniture.
- Educating children about the dangers of climbing on furniture to reach the television set or its controls.

If your existing television set is being retained and relocated, the same considerations as above should be applied.

Symbols

	Refers to alternating current (AC).
	Refers to direct current (DC).
	Refers to class II equipment.
	Refers to stand-by.
	Refers to "ON" (power).
	Refers to dangerous voltage.



The model and serial numbers of the TV are located on the back and on one side of the TV. Record them below should you ever need service.

MODEL _____
SERIAL _____



OWNER'S MANUAL

EXTERNAL CONTROL DEVICE SETUP

Please read this manual carefully before operating the set and retain it for future reference.

KEY CODES

- This feature is not available for all models.

Code (Hexa)	Function	Note	Code (Hexa)	Function	Note
00	CH +, PR +	R/C Button	53	List	R/C Button
01	CH -, PR -	R/C Button	5B	Exit	R/C Button
02	Volume +	R/C Button	60	PIP(AD)	R/C Button
03	Volume -	R/C Button	61	Blue	R/C Button
06	> (Arrow Key / Right Key)	R/C Button	63	Yellow	R/C Button
07	< (Arrow Key / Left Key)	R/C Button	71	Green	R/C Button
08	Power	R/C Button	72	Red	R/C Button
09	Mute	R/C Button	79	Ratio / Aspect Ratio	R/C Button
0B	Input	R/C Button	91	AD (Audio Description)	R/C Button
0E	SLEEP	R/C Button	9E	LIVE MENU	R/C Button
0F	TV, TV/RAD	R/C Button	7A	User Guide	R/C Button
10 - 19	* Number Key 0 - 9	R/C Button	7C	Smart / Home	R/C Button
1A	Q.View / Flashback	R/C Button	7E	SIMPLINK	R/C Button
1E	FAV (Favorite Channel)	R/C Button	8E	▶▶ (Forward)	R/C Button
20	Text (Teletext)	R/C Button	8F	◀◀ (Rewind)	R/C Button
21	T. Opt (Teletext Option)	R/C Button	AA	Info	R/C Button
28	Return (BACK)	R/C Button	AB	Program Guide	R/C Button
30	AV (Audio / Video) Mode	R/C Button	B0	▶ (Play)	R/C Button
39	Caption/Subtitle	R/C Button	B1	■ (Stop / File List)	R/C Button
40	∧ (Arrow Key / Cursor Up)	R/C Button	B5	RECENT	R/C Button
41	∨ (Arrow Key / Cursor Down)	R/C Button	BA	(Freeze / Slow Play / Pause)	R/C Button
42	My Apps	R/C Button	BB	Soccer	R/C Button
43	Menu / Settings	R/C Button	BD	● (REC)	R/C Button
44	OK / Enter	R/C Button	DC	3D	R/C Button
45	Q.Menu	R/C Button	99	AutoConfig	R/C Button
4C	List, - (ATSC Only)	R/C Button	9F	App / *	R/C Button
4D	PICTURE	R/C Button	9B	TV / PC	R/C Button
52	SOUND	R/C Button			

* Key code 4C (0x4C) is available on ATSC/ISDB models which use major/minor channel.
(For South Korea, Japan, North America, Latin America except Colombia models)

EXTERNAL CONTROL DEVICE SETUP

- Image shown may differ from your TV.

Connect the USB to Serial converter/RS-232C input jack to an external control device (such as a computer or an A/V control system) to control the product's functions externally.

Note: The type of control port on the TV can be different between model series.

- * Please be advised that not all models support this type of connectivity.
- * Cable is not provided.

USB to Serial converter with USB Cable

USB Type

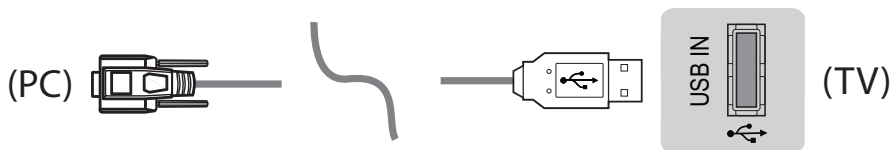

- LGTV supports PL2303 chip-based (Vendor ID : 0x0557, Product ID : 0x2008) USB to serial converter which is not made nor provided by LG.
- It can be purchased from computer stores that carry accessories for IT support professionals.

RS-232C With RS232C Cable

DE9 (D-Sub 9pin) Type

- You need to purchase the RS-232C (DE9, D-Sub 9pin female-to-female type) to RS-232C cable required for the connection between the PC and the TV, which is specified in the manual.

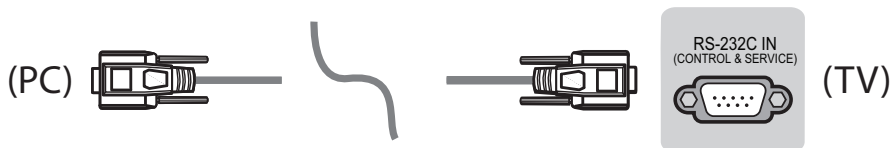

The connection interface may differ from your TV.

ENGLISH

Phone jack Type

- You need to purchase the phone-jack to RS-232 cable required for the connection between the PC and the TV, which is specified in the manual.
- * For other models, connect to the USB port.
- * The connection interface may differ from your TV.

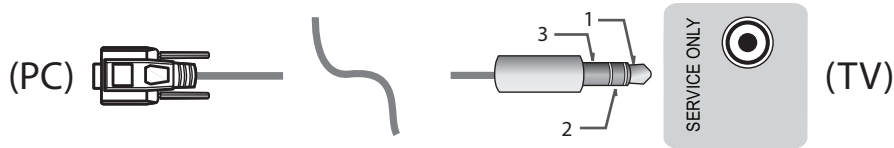

- or -

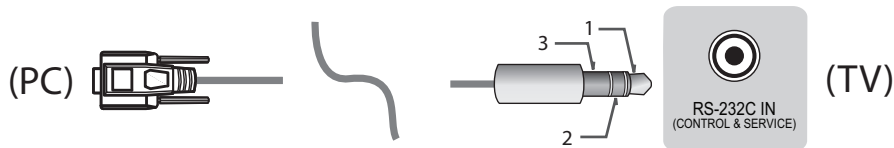

Customer Computer

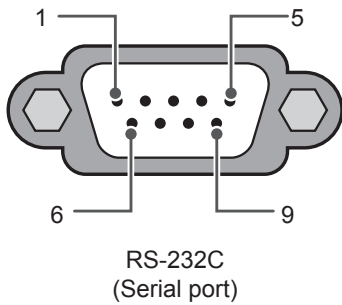

RS-232C configurations

3-Wire Configurations(Not standard)

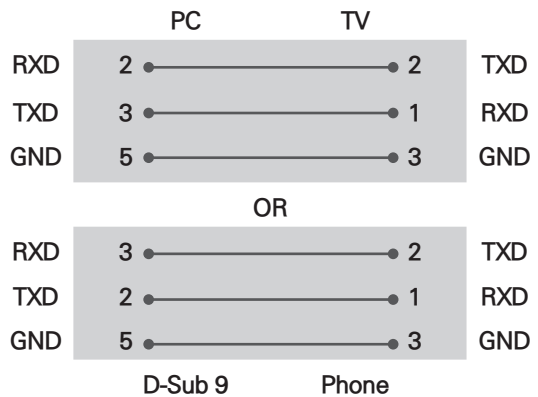

Set ID

For Set ID number, see "Real Data Mapping" on p.6

1. Press **SETTINGS** to access the main menus.
2. Press the Navigation buttons to scroll to (***General** → **About this TV or OPTION**) and press **OK**.
3. Press the Navigation buttons to scroll to **SET ID** and press **OK**.
4. Scroll left or right to select a set ID number and select **CLOSE**. The adjustment range is 1-99.
5. When you are finished, press **EXIT**.
* (Depending on model)

Communication Parameters

- Baud rate : 9600 bps (UART)
- Data length : 8 bits
- Parity : None
- Stop bit : 1 bit
- Communication code : ASCII code
- Use a crossed (reverse) cable.

Command reference list

(Depending on model)

	COMMAND1	COMMAND2	DATA (Hexadecimal)		COMMAND1	COMMAND2	DATA (Hexadecimal)
01. Power*	k	a	00 to 01	15. Balance	k	t	00 to 64
02. Aspect Ratio	k	c	(p.7)	16. Color (Colour) Temperature	x	u	00 to 64
03. Screen Mute	k	d	(p.7)	17. ISM Method (Only Plasma TV)	j	p	(p.8)
04. Volume Mute	k	e	00 to 01	18. Equalizer	j	v	(p.8)
05. Volume Control	k	f	00 to 64	19. Energy Saving	j	q	00 to 05
06. Contrast	k	g	00 to 64	20. Tune Command	m	a	(p.9)
07. Brightness	k	h	00 to 64	21. Channel (Programme) Add/Del(Skip)	m	b	00 to 01
08. Color/ Colour	k	i	00 to 64	22. Key	m	c	Key Codes
09. Tint	k	j	00 to 64	23. Control Backlight, Control Panel Light	m	g	00 to 64
10. Sharpness	k	k	00 to 32	24. Input select (Main)	x	b	(p.11)
11. OSD Select	k	l	00 to 01	25. 3D (Only 3D models)	x	t	(p.11)
12. Remote Control Lock Mode	k	m	00 to 01	26. Extended 3D (Only 3D models)	x	v	(p.12)
13. Treble	k	r	00 to 64	27. Auto Configure	j	u	(p.12)
14. Bass	k	s	00 to 64				

* Note: During playing or recording media, all commands except Power (ka) and Key (mc) are not executed and treated as NG.

With RS232C cable, TV can communicate "ka command" in power-on or power-off status. but with USB-to-Serial converter cable, the command works only if TV is on.

Transmission / Receiving Protocol

Transmission

[Command1][Command2][][Set ID][][Data][Cr]

[Command 1] : First command to control the TV. (j, k, m or x)

[Command 2] : Second command to control the TV.

[Set ID] : You can adjust the [Set ID] to choose desired monitor ID number in option menu.

Adjustment range in TV is 1 to 99. If [Set ID] value is selected to '0', every connected set can be controlled.

* [Set ID] is indicated as decimal (1 to 99) on menu and as Hexadecimal (0x00 to 0x63) on transmission/receiving protocol.

[DATA] : To transmit command data (hexadecimal). Transmit 'FF' data to read status of command.

[Cr] : Carriage Return - ASCII code '0x0D'

[] : Space - ASCII code '0x20'

OK Acknowledgement

[Command2][][Set ID][][OK][Data][x]

* The set transmits ACK (acknowledgement) based on this format when receiving normal data. At this time, if the data is data read mode, it indicates present status data. If the data is data write mode, it returns the data of the PC computer.

Error Acknowledgement

[Command2][][Set ID][][NG][Data][x]

* The set transmits ACK (acknowledgement) based on this format when receiving abnormal data from non-viable functions or communication errors.

Data 00: Illegal Code

Real data mapping (Hexadecimal b Decimal)

* When you enter the [data] in hexadecimal, refer to following conversion table.

* Channel Tune (ma) Command uses two-byte hexadecimal value([data]) to select channel number.

00 : Step 0	32 : Step 50 (Set ID 50)	FE : Step 254
01 : Step 1 (Set ID 1)	33 : Step 51 (Set ID 51)	FF : Step 255
...
0A : Step 10 (Set ID 10)	63 : Step 99 (Set ID 99)	01 00 : Step 256
...
0F : Step 15 (Set ID 15)	C7 : Step 199	27 0E : Step 9998
10 : Step 16 (Set ID 16)	C8 : Step 200	27 0F : Step 9999
...

* Commands may work differently depending on model and signal.

01. Power (Command: k a)

- ▶ To control Power *On or Off of the set.

Transmission [k][a][][Set ID][][Data][Cr]

Data 00 : Power Off 01 : *Power On

Ack [a][][Set ID][][OK/NG][Data][x]

- ▶ To Show TV is Power On or *Off

Transmission [k][a][][Set ID][][FF][Cr]

Ack [a][][Set ID][][OK][Data][x]

* Similarly, if other functions transmit 'FF' data based on this format, Acknowledgement feedback presents status about each function.

02. Aspect Ratio (Command: k c)

(Main Picture Size)

- ▶ To adjust the screen format. (Main picture format)
You can also adjust the screen format using the Aspect Ratio in the Q.MENU. or PICTURE menu.

Transmission [k][c][][Set ID][][Data][Cr]

Data 01 : Normal screen 07 : 14:9
(4:3) (Europe, Colombia, Mid-East,
02 : Wide screen Asia except South Korea and
(16:9) Japan)
04 : Zoom 09 : * Just Scan
05 : Zoom 2 0B : Full Wide
(Latin America (Europe, Colombia, Mid-
except Colombia East, Asia except South
Only) Korea and Japan)
06 : Set by Program/ 10 to 1F : Cinema Zoom 1 to 16
Original 0c : 21:9 (Depending on model)

Ack [c][][Set ID][][OK/NG][Data][x]

- * Using the PC input, you select either 16:9 or 4:3 screen aspect ratio.
- * In DTV/HDMI/Component mode (high-definition), Just Scan is available.
- * Full wide mode may work differently based on model and is supported for DTV fully, and ATV, AV partially.

03. Screen Mute (Command: k d)

- ▶ To select screen mute on/off.

Transmission [k][d][][Set ID][][Data][Cr]

Data 00 : Screen mute off (Picture on)
Video mute off
01 : Screen mute on (Picture off)
10 : Video mute on

Ack [d][][Set ID][][OK/NG][Data][x]

* In case of video mute on only, TV will display On Screen Display(OSD). But, in case of Screen mute on, TV will not display OSD.

04. Volume Mute (Command: k e)

- ▶ To control volume mute on/off.
You can also adjust mute using the MUTE button on remote control.

Transmission [k][e][][Set ID][][Data][Cr]

Data 00 : Volume mute on (Volume off)
01 : Volume mute off (Volume on)

Ack [e][][Set ID][][OK/NG][Data][x]

05. Volume Control (Command: k f)

- ▶ To adjust volume.
You can also adjust volume with the volume buttons on remote control.

Transmission [k][f][][Set ID][][Data][Cr]

Data Min : 00 to Max : 64

Ack [f][][Set ID][][OK/NG][Data][x]

06. Contrast (Command: k g)

- ▶ To adjust screen contrast.
You can also adjust contrast in the PICTURE menu.

Transmission [k][g][][Set ID][][Data][Cr]

Data Min : 00 to Max : 64

Ack [g][][Set ID][][OK/NG][Data][x]

07. Brightness (Command: k h)

- ▶ To adjust screen brightness.
You can also adjust brightness in the PICTURE menu.

Transmission [k][h][][Set ID][][Data][Cr]

Data Min : 00 to Max : 64

Ack [h][][Set ID][][OK/NG][Data][x]

08. Color/Colour (Command: k i)

- ▶ To adjust the screen Color(Colour).
You can also adjust colour in the PICTURE menu.

Transmission [k][i][][Set ID][][Data][Cr]

Data Min : 00 to Max : 64

Ack [i][][Set ID][][OK/NG][Data][x]

09. Tint (Command: k j)

- ▶ To adjust the screen tint.
You can also adjust tint in the PICTURE menu.

Transmission [k][j][][Set ID][][Data][Cr]

Data Red : 00 to Green : 64

Ack [j][][Set ID][][OK/NG][Data][x]

10. Sharpness (Command: k k)

- ▶ To adjust the screen sharpness.
You can also adjust sharpness in the PICTURE menu.

Transmission [k][k][][Set ID][][Data][Cr]

Data Min : 00 to Max : 32

Ack [k][][Set ID][][OK/NG][Data][x]

11. OSD Select (Command: k l)

- ▶ To select OSD (On Screen Display) on/off when controlling remotely.

Transmission [k][l][][Set ID][][Data][Cr]

Data 00 : OSD off 01 : OSD on

Ack [l][][Set ID][][OK/NG][Data][x]

12. Remote control lock mode (Command: k m)

- ▶ To lock the front panel controls on the monitor and remote control.

Transmission [k][m][][Set ID][][Data][Cr]

Data 00 : Lock off 01 : Lock on

Ack [m][][Set ID][][OK/NG][Data][x]

- * If you are not using the remote control, use this mode.
When main power is off & on (plug-off and plug-in, after 20 - 30 seconds), external control lock is released.
- * In the standby mode (DC off by off timer or 'ka', 'mc' command), and if key lock is on, TV will not turn on by power on key of IR & Local Key.

13. Treble (Command: k r)

- ▶ To adjust treble.
You can also adjust in the AUDIO menu.

Transmission [k][r][][Set ID][][Data][Cr]

Data Min : 00 to Max : 64

Ack [r][][Set ID][][OK/NG][Data][x]

*(Depending on model)

14. Bass (Command: k s)

- ▶ To adjust Bass.
You can also adjust in the AUDIO menu.

Transmission [k][s][][Set ID][][Data][Cr]

Data Min : 00 to Max : 64

Ack [s][][Set ID][][OK/NG][Data][x]

*(Depending on model)

15. Balance (Command: k t)

- ▶ To adjust balance.
You can also adjust balance in the AUDIO menu.

Transmission [k][t][][Set ID][][Data][Cr]

Data Min : 00 to Max : 64

Ack [t][][Set ID][][OK/NG][Data][x]

16. Color(Colour) Temperature (Command: x u)

- ▶ To adjust colour temperature. You can also adjust Color(Colour) Temperature in the PICTURE menu.

Transmission [x][u][][Set ID][][Data][Cr]

Data Min : 00 to Max : 64

Ack [u][][Set ID][][OK/NG][Data][x]

17. ISM Method (Command: j p) (Only Plasma TV)

- ▶ To control the ISM method. You can also adjust ISM Method in OPTION menu.

Transmission [j][p][][Set ID][][Data][Cr]

Data Min : 02: Orbiter

08: Normal

20: Color(Colour) Wash

Ack [p][][Set ID][][OK/NG][Data][x]

18. Equalizer (Command : j v)

▶ Adjust EQ of the set.

Transmission [j][v][][Set ID][][Data][Cr]

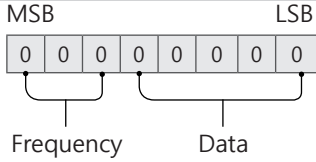

7	6	5	Frequency	4	3	2	1	0	Step
0	0	0	1st Band	0	0	0	0	0	0(decimal)
0	0	1	2nd Band	0	0	0	0	1	1(decimal)
0	1	0	3rd Band
0	1	1	4th Band	1	0	0	1	1	19(decimal)
1	0	0	5th Band	1	0	1	0	1	20(decimal)

Acknowledgement [v][][Set ID][][OK/NG][Data][x]

* It depends on model, and can adjust when sound mode is EQ adjustable value.

19. Energy Saving (Command: j q)

▶ To reduce the power consumption of the TV. You can also adjust Energy Saving in PICTURE menu.

Transmission [j][q][][Set ID][][Data][Cr]

Data

- 00 : Off
- 01 : Minimum
- 02 : Medium
- 03 : Maximum
- 04 : Auto (For LCD TV / LED TV) / Intelligent sensor (For PDP TV)
- 05 : Screen off

* (Depending on model)

Ack [q][][Set ID][][OK/NG][Data][x]

20. Tune Command (Command: m a)

* This command may work differently depending on model and signal.

- For Europe, Mid-East, Colombia, Asia except South Korea and Japan Model

▶ Select channel to following physical number.

Transmission [m][a][][Set ID][][Data 00][][Data 01][][Data 02][Cr]

* Analog Antenna/Cable

[Data 00][Data 01] Channel Data
 Data 00 : High byte channel data
 Data 01 : Low byte channel data
 - 00 00 ~ 00 C7 (Decimal : 0 ~ 199)

Data 02 : Input Source (Analog)
 - 00 : Antenna TV (ATV)
 - 80 : Cable TV (CATV)

* Digital Antenna/Cable/Satellite

[Data 00][Data 01]: Channel Data
 Data 00 : High Channel data
 Data 01 : Low Channel data
 - 00 00 ~ 27 0F (Decimal: 0 ~ 9999)
 Data 02 : Input Source (Digital)
 - 10 : Antenna TV (DTV)
 - 20 : Antenna Radio (Radio)
 - 40 : Satellite TV (SDTV)
 - 50 : Satellite Radio (S-Radio)
 - 90 : Cable TV (CADTV)
 - a0 : Cable Radio (CA-Radio)

* Tune Command Examples:

1. Tune to the Analog antenna (PAL) Channel 10.
 Set ID = All = 00
 Data 00 & 01 = Channel Data is 10 = 00 0a
 Data 02 = Analog Antenna TV = 00
 Result = **ma 00 00 0a 00**
2. Tune to the digital antenna (DVB-T) Channel 01.
 Set ID = All = 00
 Data 00 & 01 = Channel Data is 1 = 00 01
 Data 02 = Digital Antenna TV = 10
 Result = **ma 00 00 01 10**
3. Tune to the satellite (DVB-S) Channel 1000.
 Set ID = All = 00
 Data 00 & 01 = Channel Data is 1000 = 03 E8
 Data 02 = Digital Satellite TV = 40
 Result = **ma 00 03 E8 40**

Ack [a][][Set ID][][OK][Data 00][Data 01][Data 02][x][a][][Set ID][][NG][Data 00][x]

- For South Korea, North/Latin America except Colombia Model
- ▶ To tune channel to following physical/major/minor number.

Transmission [m][a][][0][][Data00][][Data01][][Data02][][Data03][][Data04][][Data05][Cr]

Digital channels have a Physical, Major, and Minor channel number. The Physical number is the actual digital channel number, the Major is the number that the channel should be mapped to, and the Minor is the sub-channel. Since the ATSC tuner automatically maps the channel from the Major / Minor number, the Physical number is not required when sending a command in Digital.

* Analog Antenna/Cable

Data 00 : Physical Channel Number

- Antenna (ATV) : 02~45 (Decimal: 2 ~ 69)
- Cable (CATV) : 01, 0E~7D (Decimal : 1, 14~125)

[Data 01 ~ 04]: Major/Minor Channel Number

Data 01 & 02: xx (Don't care)

Data 03 & 04: xx (Don't care)

Data 05: Input Source (Analog)

- 00 : Antenna TV (ATV)
- 01 : Cable TV (CATV)

* Digital Antenna/Cable

Data 00 : xx (Don't care)

[Data 01][Data 02]: Major Channel Number

Data 01 : High byte Channel Data

Data 02 : Low byte Channel Data

- 00 01 ~ 27 0F (Decimal: 1 ~ 9999)

[Data 03][Data 04]: Minor Channel Number

Data 03 : High byte Channel Data

Data 04 : Low byte Channel Data

Data 05 : Input Source (Digital)

- 02 : Antenna TV (DTV) – Use Physical Channel Number
- 06 : Cable TV (CADTV) – Use Physical Channel Number
- 22 : Antenna TV (DTV) – Don't Use Physical Channel Number
- 26 : Cable TV (CADTV) - Don't Use Physical Channel Number
- 46 : Cable TV (CADTV) – Use Physical/Major Channel Number Only (One Part Channel)
- 66 : Cable TV (CADTV) – Use Major Channel Number Only (One Part Channel)
- 0b : Cable DTV Plus – Use Physical Channel Number
- 2b : Cable DTV Plus – Don't Use Physical Channel Number
- 4b : Cable DTV Plus – Use Physical/Major Channel Number Only (One Part Channel)
- 6b : Cable DTV Plus – Use Major Channel Number Only (One Part Channel)

Two bytes are available for each major and minor channel data, but usually the low byte is used alone (high byte is 0).

* Tune Command Examples:

1. Tune to the Analog cable (NTSC) channel 35.

Set ID = All = 00

Data 00 = Channel Data is 35 = 23

Data 01 & 02 = No Major = 00 00

Data 03 & 04 = No Minor = 00 00

Data 05 = Analog Cable TV = 01

Total = **ma 00 23 00 00 00 01**

2. Tune to the digital antenna (ATSC) channel 30-3.

Set ID = All = 00

Data 00 = Don't know Physical = 00

Data 01 & 02 = Major is 30 = 00 1E

Data 03 & 04 = Minor is 3 = 00 03

Data 05 = Digital Antenna TV = 22

Total = **ma 00 00 00 1E 00 03 22**

Ack [a][][Set ID][][OK][Data 00][Data 01]

[Data 02][Data 03][Data 04][Data 05]

[x][a][][Set ID][][NG][Data 00][x]

• For Japan Model

- ▶ To tune channel to following physical/major/minor number.

Transmission [m][a][][0][][Data00][][Data01]

[][Data02][][Data03][][Data04][][Data05][Cr]

* Digital Antenna/Satellite

Data 00: xx (Don't care)

[Data 01][Data 02]: Major Channel Number

Data 01: High byte Channel Data

Data 02: Low byte Channel Data

- 00 01 ~ 27 0F (Decimal: 1 ~ 9999)

[Data 03][Data 04]: Minor/Branch Channel Number

(Don't care in Satellite)

Data 03: High byte Channel Data

Data 04: Low byte Channel Data

Data 05 : Input Source (Digital/Satellite for Japan)

- 02 : Antenna TV (DTV)
- 42 : Antenna TV (DTV) – Use Physical/Major Channel Number Only (One Part Channel)
- 62 : Antenna TV (DTV) – Use Major Channel Number Only (One Part Channel)
- 07 : BS (Broadcasting Satellite)
- 08 : CS1 (Communication Satellite 1)
- 09 : CS2 (Communication Satellite 2)

* Tune Command Examples:

1. Tune to the digital antenna (ISDB-T) channel 17-1.

Set ID = All = 00

Data 00 = Don't know Physical = 00

Data 01 & 02 = Major is 17 = 00 11

Data 03 & 04 = Minor/Branch is 1 = 00 01

Data 05 = Digital Antenna TV = 02

Total = **ma 00 00 00 11 00 01 02**

2. Tune to the BS (ISDB-BS) channel 30.

Set ID = All = 00

Data 00 = Don't know Physical = 00

Data 01 & 02 = Major is 30 = 00 1E

Data 03 & 04 = Don't Care = 00 00

Data 05 = Digital BS TV = 07

Total = **ma 00 00 00 1E 00 00 07**

* This feature is varied based on the model.

Ack [a][][Set ID][][OK][Data 00][Data 01]

[Data 02][Data 03][Data 04][Data 05]

[x][a][][Set ID][][NG][Data 00][x]

21. Channel(Programme) Add/Del(Skip)

(Command: m b)

▶ To skip current channel(programme) for next time.

Transmission [m][b][][Set ID][][Data][Cr]

Data 00 : Del(ATSC,ISDB)/Skip(DVB) 01 : Add

Ack [b][][Set ID][][OK/NG][Data][x]

* Set the saved channel status to del(ATSC, ISDB)/skip(DVB) or add.

22. Key (Command: m c)

▶ To send IR remote key code.

Transmission [m][c][][Set ID][][Data][Cr]

Data Key code - p.2.

Ack [c][][Set ID][][OK/NG][Data][x]

23. Control Backlight (Command: m g)

• For LCD TV / LED TV

▶ To control the backlight.

Transmission [m][g][][Set ID][][Data][Cr]

Data Min : 00 to Max : 64

Ack [g][][Set ID][][OK/NG][Data][x]

Control Panel Light (Command: m g)

• For Plasma TV

▶ To control the panel light.

Transmission [m][g][][Set ID][][Data][Cr]

Data Min : 00 to Max : 64

Ack [g][][Set ID][][OK/NG][Data][x]

24. Input select (Command: x b)

(Main Picture Input)

▶ To select input source for main picture.

Transmission [x][b][][Set ID][][Data][Cr]

Data

00 : DTV 01 : CADTV

02 : Satellite DTV 10 : ATV

ISDB-BS (Japan)

03 : ISDB-CS1 (Japan)

04 : ISDB-CS2 (Japan)

11 : CATV

20 : AV or AV1 21 : AV2

40 : Component1 41 : Component2

60 : RGB

90 : HDMI1 91 : HDMI2

92 : HDMI3 93 : HDMI4

Ack [b][][Set ID][][OK/NG][Data][x]

* This function depends on model and signal.

25. 3D(Command: x t) (only 3D models)

(Depending on model)

▶ To change 3D mode for TV.

Transmission [x][t][][Set ID][][Data 00][][Data 01]

[][Data 02][][Data 03][Cr]

* (Depending on model)

Data Structure

[Data 00] 00 : 3D On

01 : 3D Off

02 : 3D to 2D

03 : 2D to 3D

[Data 01] 00 : Top and Bottom

01 : Side by Side

02 : Check Board

03 : Frame Sequential

04 : Column interleaving

05 : Row interleaving

[Data 02] 00 : Right to Left

01 : Left to Right

[Data 03] 3D Effect(3D Depth): Min : 00 - Max : 14

(*transmit by Hexadecimal code)

- * [Data 02], [Data 03] functions depend on model and signal.
- * If [Data 00] is 00 (3D On), [Data 03] has no meaning.
- * If [Data 00] is 01 (3D off) or 02 (3D to 2D), [Data 01], [Data 02] and [Data 03] have no meaning.
- * If [Data 00] is 03 (2D to 3D), [Data 01] and [Data 02] have no meaning.
- * If [Data 00] is 00 (3D On) or 03 (2D to 3D), [Data 03] works when 3D Mode (Genre) is manual only.
- * All 3D pattern options ([Data 01]) may not be available according to broadcasting/video signal.

[Data 00]	[Data 01]	[Data 02]	[Data 03]
00	O	O	O
01	X	X	X
02	X	X	X
03	X	O	O

X : don't care

Ack [t][][Set ID][][OK][Data00][Data01][Data02][Data03][x]
[t][][Set ID][][NG][Data00][x]

26. Extended 3D(Command: x v) (only 3D models) (Depending on model)

- ▶ To change 3D option for TV.

Transmission [x][v][][Set ID][][Data 00][][Data 01][Cr]

[Data 00] 3D option

- 00 : 3D Picture Correction
- 01 : 3D Depth (3D Mode is Manual Only)
- 02 : 3D Viewpoint
- 06 : 3D Color Correction
- 07 : 3D Sound Zooming
- 08 : Normal Image View
- 09 : 3D Mode (Genre)

[Data 01] It has own range for each 3D option determined by [Data 00].

- 1) When [Data 00] is 00
 - 00 : Right to Left
 - 01 : Left to Right

- 2) When [Data 00] is 01, 02

Data Min: 0 - Max: 14 (*transmit by Hexadecimal code)

Data value range(0 - 20) converts Viewpoint range (-10 - +10) automatically (Depending on model)

- * This option works when 3D Mode (Genre) is manual only.

- 3) When [Data 00] is 06, 07

- 00 : Off
- 01 : On

- 4) When [Data 00] is 08

- 00 : Revert to 3D video from 3D-to-2D converted 2D video
- 01 : Change 3D video to 2D video, except 2D-to-3D video

- * If conversion condition doesn't meet, command is treated as NG.

- 5) When [Data 00] is 09

- 00 : Standard
- 01 : Sport
- 02 : Cinema
- 03 : Extreme
- 04 : Manual
- 05 : Auto

Ack [v][][Set ID][][OK][Data00][Data01][x]
[v][][Set ID][][NG][Data00][x]

27. Auto Configure (Command: j u) (Depending on model)

- ▶ To adjust picture position and minimize image shaking automatically. It works only in RGB (PC) mode.

Transmission [j][u][][Set ID][][Data][Cr]



Data 01 : To set Auto Configure

Ack [u][][Set ID][][OK/NG][Data][x]





- * Image shown may differ from your TV.
- * Image shown on a PC or mobile phone may vary depending upon the Operating System (OS).
- * Depending upon the version of the software, icon position can be changed.

Network Settings

- 1 Press the  (**Home**) button to access the Smarthome menu. Select  (**Settings**) and press  (**Wheel (OK)**).



- 2 Select  (**All Settings**) and press  (**Wheel (OK)**).



- 3 Select the **Network**  **Wired Connection (Ethernet)** or **Wi-Fi Connection**.

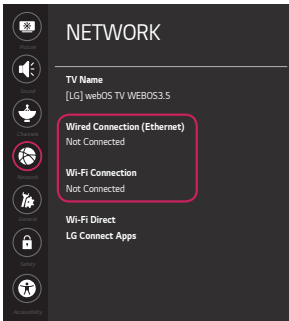

- 4 The device automatically tries to connect to the available network (wired network first). When you select the **Wi-Fi Connection**, the network list available is displayed. Choose the network you wish to use. For wireless AP (Router) that has the  symbol, you need to enter the security key.



- 5 If the connection is completed, **Connected to Internet** is displayed.

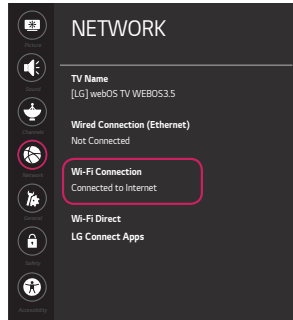

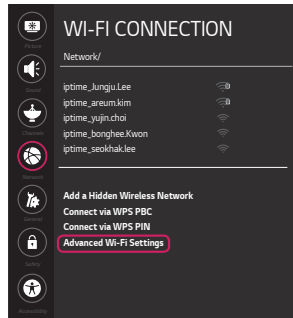

You can check the status of connection in **Advanced Wi-Fi Settings**.





Troubleshooting Network Problems

Depending upon the version of the software, icon position can be changed.

ENGLISH

- 1 Press the  (**Home**) button to access the SmartHome menu. Select  (**Settings**) and press  **Wheel (OK)**.



- 2 Select  (**All Settings**) and press  **Wheel (OK)**.



- 3 Select the **Network**  **Wired Connection (Ethernet)** or **Wi-Fi Connection**  **Advanced Wi-Fi Settings**.



Follow the instructions below that match to your network status.

Check the TV or the AP (Router).

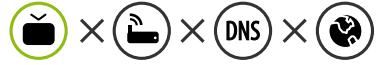

When X appears next to TV:

- 1 Check the connection status of the TV, AP (Router) and cable modem.
- 2 Power off and power on in the following order; (1st) the cable modem, wait for the cable modem to reset, (2nd) the AP (Router), wait for the AP (Router) to reset and (3rd) the TV.
- 3 If you are using a static IP, enter the IP directly.
- 4 Contact Internet service provider or AP (Router) manufacturer.

Check the AP (Router) or consult your Internet service provider.



When X appears next to Gateway:

- 1 Unplug the power cord of the AP (Router) or cable modem, wait 5 seconds. Reapply power.
- 2 Initialize (Reset) the AP (Router) or cable modem.
- 3 Contact Internet service provider or AP (Router) manufacturer.



When X appears next to DNS:

- 1 Unplug the power cord of the AP (Router) or cable modem, wait 5 seconds. Reapply power.
- 2 After the cable modem or AP (Router) has initialized (Reset), try to reconnect.
- 3 Check that the MAC address of the TV/AP (Router) is registered with your Internet service provider. (The MAC address displayed on the right pane of the network status window should be registered with your Internet service provider.)
- 4 Check the AP (Router) manufacturer's website to make sure your router has the latest firmware version installed.

SmartShare PC SW Installation & Setting

Install the SmartShare PC SW program on your PC.

- 1 Go to www.lg.com. Then, select your region.
- 2 Select **Support**.
- 3 Select **Software & Drivers**. Then, select **SmartShare**.
- 4 Download the SmartShare PC SW and install it on your PC. You can run the program when installation is complete.

! NOTE

- SmartShare service is only available if TV and other devices are connected to the same AP (Router).

SmartShare Connection to Smartphone



- 1 Check that Wi-Fi is enabled on your smartphone.
To use **SmartShare**, both devices must be on the same local network.
- 2 Install/run the app for sharing content on your smartphone (it's called LG TV Plus on LG phones).
- 3 Enable your smartphone to share content files with other devices.
- 4 Open **Device Connector** application on TV.
Home (Home) > Device Connector > Smartphone > CONTENT SHARE.
- 5 Select the file type you want to play (movie, audio, or photo).
- 6 Select a movie, music, or photo to play on the TV.
- 7 Play the media file to view and enjoy it on your TV.

Updating the TV Firmware

Home (Home) > Settings > All Settings > General > About This TV > CHECK FOR UPDATES

You can check the Software Version and update it.

If **Allow Automatic Updates** is selected, when an update is available, the update automatically starts without prompting a question.

* When the TV is turned on for the first time after a software update, initialization of the TV may take approximately one minute.

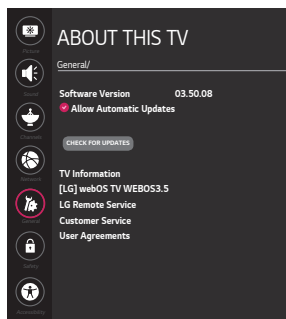
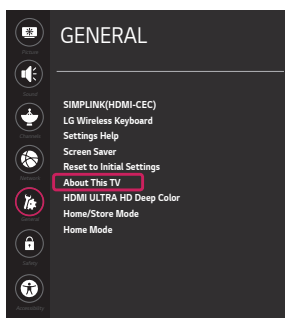

Wi-Fi Direct Setting

(Home) (Settings) (All Settings) Network Wi-Fi Direct

If a local network is not available, you can connect a portable device directly to the TV using **Wi-Fi Direct**. With **SmartShare**, you can share files or screens of devices connected to **Wi-Fi Direct**.

ENGLISH



- 1 When you open **Wi-Fi Direct** menu, a list of available devices appears. Select your device.
 - 2 When you are prompted to the connection request, select **OK. Wi-Fi Direct** is now connected to your TV.
- * You can only use devices that support **Wi-Fi Direct**.

Screen sharing Setting



Screen sharing allows a portable device to send video and sound securely to the TV wirelessly.

(Home) / (Input) (Screen Share)

- 1 Screen sharing should be set to ON on your portable device.
 - 2 When your TV is detected, select the device on your portable device.
When connection is completed, the device screen appears on the TV screen.
- * If you turn Listen Mode to **ON** after launching the Screen Share app, you can connect the device without starting the Screen Share app.

WiDi (Wireless Display) Setting

Intel® WiDi (Wireless Display) technology enables easy and fast connection without wires or internet network for mirrored and dual monitor display on your TV. You can sit back and experience your favorite movies, videos, photos, online shows and more in full HD on your TV with great image clarity and sound.

(Home) / (Input) (Screen Share)

- 1 On the TV Intel® WiDi is set to **On**. Your laptop runs the Intel® WiDi program.







* LG TVs do not need to register.

* For more information on Intel® WiDi, visit <http://intel.com/go/widi>.

- 2 It detects LG Smart TVs available, which supports WiDi. In the list, select the TV you want and click Connect. Enter the number shown on the screen into the input field (a) on your laptop and then click Continue.
- 3 The laptop screen appears on the TV screen. The wireless environment may affect the screen display. If the connection is poor, the Intel® WiDi connection may be lost.



Checkpoints

- Make sure that you have the latest version of the software.
 - If you are using a Wi-Fi router, check whether you have the latest firmware installed.
 - If there are any available updates, update the firmware according to the manufacturer's instructions.
 - Check the current software version and if there is an available update, install it.
-  (Home)  (Settings)  (All Settings)  General  About This TV  Software Version
- Check if the same symptom occurs with two or more Wi-Fi devices.
 - Wi-Fi problems may be related to network condition and a device that is connected to the network.
 - If other Wi-Fi devices can connect to the Internet at the same location as the TV, then your Wi-Fi router is probably normal.
- Check the power and Ethernet cables of the Wi-Fi router.
 - When the Ethernet cable connected to the Wi-Fi router is loose or disconnected, network problems can occur.
 - Check all power and Ethernet cables of the Wi-Fi router to see if they are correctly connected.
- Check the Wi-Fi router to see if the router is set to the recommended wireless settings. If network problems continue, reset your network devices.
- Check the signal strength of the Wi-Fi router to connect to from the TV UI.
 - The  that is next to the Wi-Fi router name (SSID) in the menu indicates the sensitivity of the receiver.
 - It is recommended that you connect to a Wi-Fi network with 3 or more bars of signal strength.
 - If the number of bars indicating signal strength are less than 3, the network connection status may be weak or unstable, so shorten the distance between the Wi-Fi router and the TV.
- If the signal strength of the Wi-Fi router is weak, wireless speed slowdowns and network disconnection may occur.
- To supplement wireless coverage of network equipment, your Wi-Fi router should be placed in the middle of the network equipment.

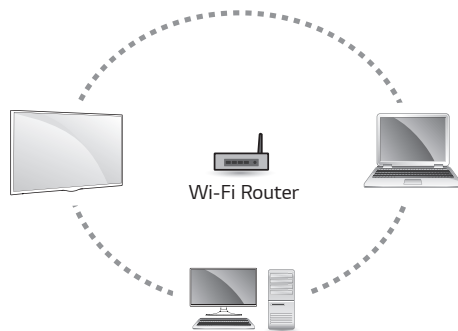

- Interference Factors
 - If there is any interference from surrounding equipment, the network connection may be weak or unstable.
 - Wireless telephones that operate in the 2.4 GHz or 5 GHz bandwidth
 - Wireless speakers that operate in the 2.4 GHz or 5 GHz bandwidth
 - Video transmitters that operate in the 2.4 GHz or 5 GHz bandwidth
 - Other wireless devices (Microwaves, cameras, baby monitors, neighboring wireless devices, etc.) that operate in the 2.4 GHz or 5 GHz bandwidth.
- How to reduce the effects of interference between Wi-Fi and Bluetooth devices
 - Set the channel on your wireless network equipment to avoid the 2.4 GHz or 5 GHz bandwidth which has lots of interference.
 - If possible, use the 5 GHz wireless network.
 - If the Wi-Fi router is located too far away or in environments with high interference, the network connection may be weak or unstable.
 - In this case, move the Wi-Fi router closer to the TV or check if there are any obstructions (e.g., concrete walls, cabinets) between the two devices.
- Radio Frequency (RF) Interference and Absorbing Obstructions

Type of Barrier	Interference Potential	Type of Barrier	Interference Potential	Type of Barrier	Interference Potential
Wood	Low	Water	Medium	Plaster	High
Synthetic material	Low	Bricks	Medium	Concrete	High
Glass	Low	Marble	Medium	Bulletproof glass	High
Metal	Very High				