



ENGLISH

Easy Setup Guide

Please read this manual carefully before operating your set and retain it for future reference.

ESPAÑOL

Guía Rápida de Configuración

Lea atentamente este manual antes de poner en marcha el equipo y consérvelo para futuras consultas.

FRANÇAIS

Guide de configuration rapide

Avant d'utiliser l'appareil, veuillez lire attentivement ce manuel et le conserver pour pouvoir vous y reporter ultérieurement.

LED TV

32LJ500B

43LJ5000

43LJ500M

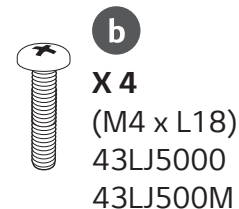
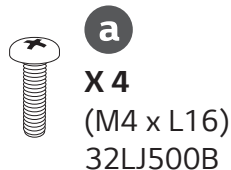
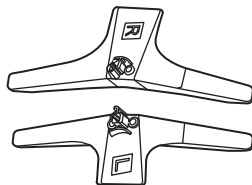
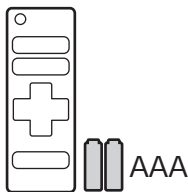
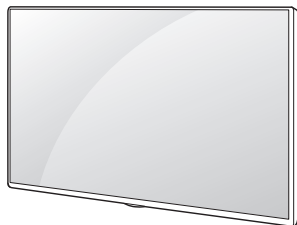

www.lg.com

P/No: MFL69677801 (1702-REV01)



ENGLISH Read **Safety & Reference**.

ESPAÑOL Leer **Seguridad y Consultas**.

FRANÇAIS Lisez **Sécurité et références**.

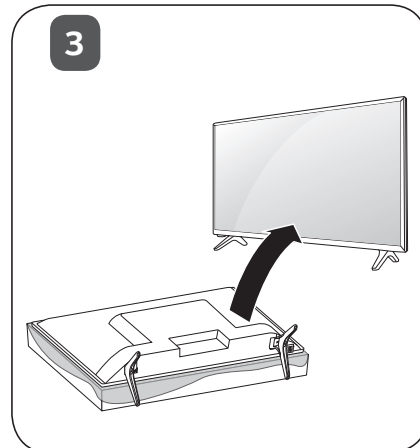
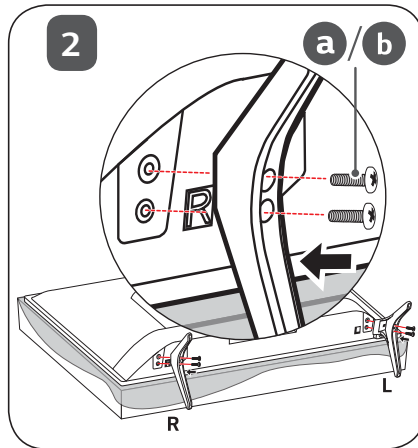
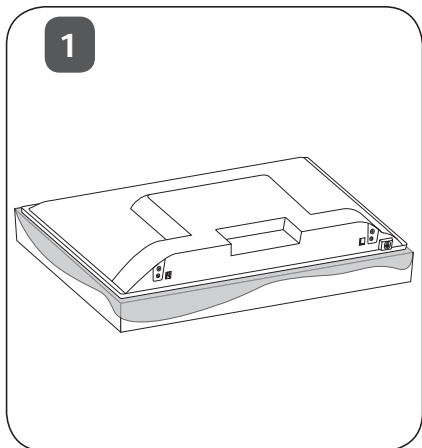

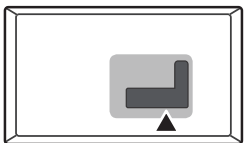

ANTENNA /
CABLE IN

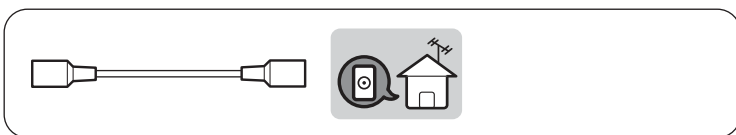

HDMI IN

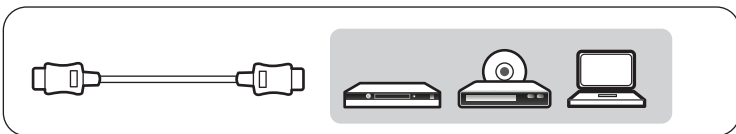

USB IN



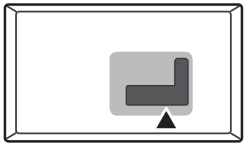

COMPONENT IN

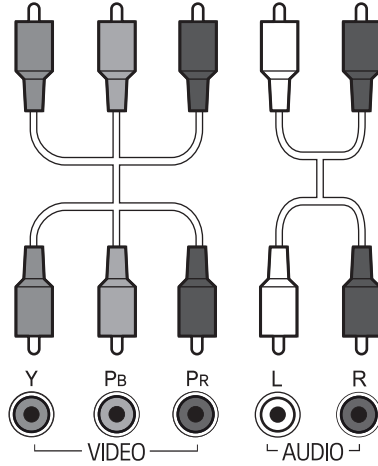
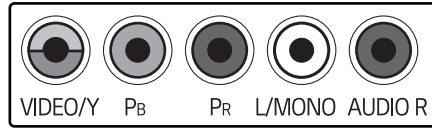

AV IN

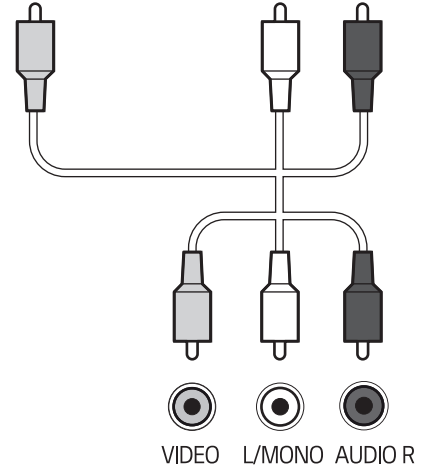
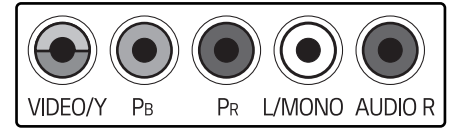

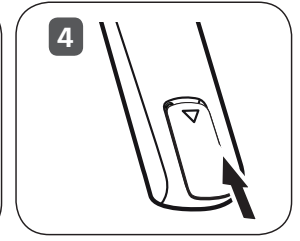
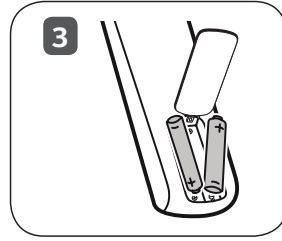
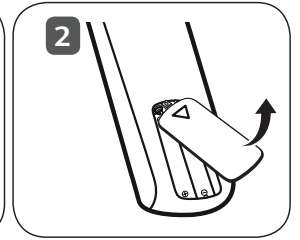
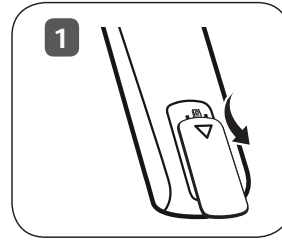
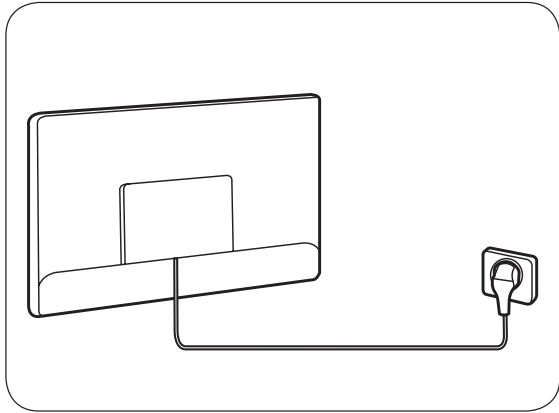

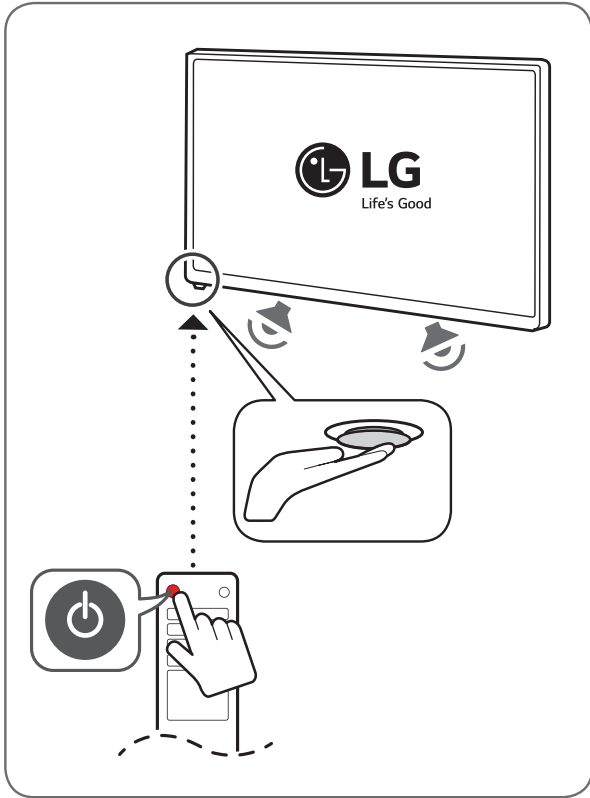

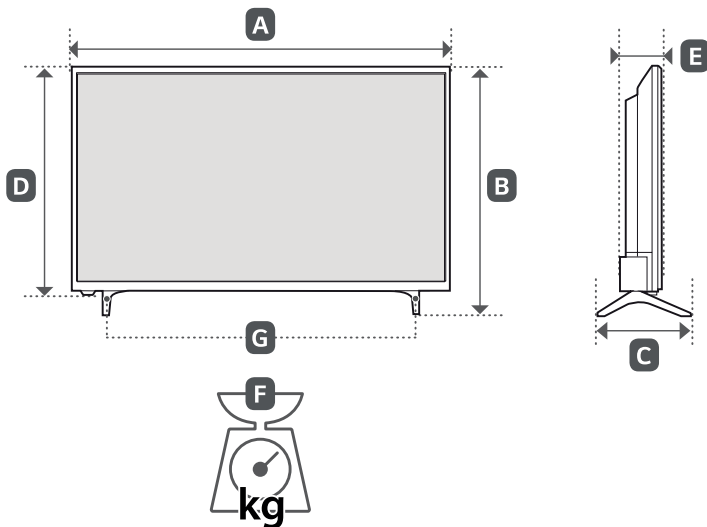

(lbs / libras / lb)

A, B, C, D, E : mm (inches / pulgadas / po)
F, G : kg (lbs / libras / lb)

MODELS	A		B		C		D		E		F		F - G		Current value / Power consumption	
MODELOS	A		B		C		D		E		F		F - G		Corriente de consumo / Consumo de potencia	
MODÈLES	A		B		C		D		E		F		F - G		Valeur courante / Consommation électrique	
32LJ500B-UB	729 (28,7)	729 (28,7)	474 (18,6)	474 (18,6)	182,8 (7,1)	182,8 (7,1)	436 (17,1)	436 (17,1)	75,8 (2,9)	75,8 (2,9)	3,9 (8,5)	3,9 (8,5)	3,8 (8,3)	3,8 (8,3)	1,0 A / 55 W	1,0 A / 55 W
43LJ5000-UB	968 (38,1)	968 (38,1)	625 (24,6)	625 (24,6)	217,8 (8,5)	217,8 (8,5)	569 (22,4)	569 (22,4)	82,3 (3,2)	82,3 (3,2)	7,1 (15,6)	7,1 (15,6)	6,9 (15,2)	6,9 (15,2)	1,5 A / 74 W	1,5 A / 74 W
43LJ500M-UB																
Power requirement / Alimentation					For USA and Canada / Pour les États-Unis et le Canada							AC 120 V ~ 60 Hz				
Alimentación requerida					Para México							AC 127 V ~ 60 Hz				





OWNER'S MANUAL

Safety and Reference

LED TV*

* LG LED TVs are LCD TVs with LED backlighting.

Please read this manual carefully before operating your TV and retain it for future reference.

32LJ500B

43LJ5000

43LJ500M



* M F L 6 9 7 1 7 1 0 1 *

www.lg.com

P/NO : MFL69717101 (1702-REV04)

Warning! Important Safety instructions

Read these instructions. Keep these instructions. Heed all warnings. Follow all instructions.



CAUTION
RISK OF ELECTRIC SHOCK
DO NOT OPEN



CAUTION : TO REDUCE THE RISK OF ELECTRIC SHOCK DO NOT REMOVE COVER (OR BACK). NO USER SERVICEABLE PARTS INSIDE. REFER TO QUALIFIED SERVICE PERSONNEL.

 The symbol is intended to alert the user to the presence of uninsulated dangerous voltage within the product's enclosure that may be of sufficient magnitude to constitute a risk of electric shock to persons.

 The symbol is intended to alert the user to the presence of important operating and maintenance (servicing) instructions in the literature accompanying the device.

WARNING : TO REDUCE THE RISK OF FIRE AND ELECTRIC SHOCK, DO NOT EXPOSE THIS PRODUCT TO RAIN OR MOISTURE.



- Use only with the cart, stand, tripod, bracket, or table specified by the manufacturer, or sold with the apparatus. When a cart is used, use caution when moving the cart/apparatus combination to avoid injury from tip-over.

- Unplug this apparatus during lightning storms or when unused for long periods of time.
- Refer all servicing to qualified service personnel. Servicing is required when the apparatus has been damaged in any way, such as power-supply cord or plug is damaged, liquid has been spilled or objects have fallen into the apparatus, the apparatus has been exposed to rain or moisture, does not operate normally, or has been dropped.
- Do not press strongly upon the panel with a hand or a sharp object such as a nail, pencil, or pen, or make a scratch on it.
- Do not stick metal objects or any other conductive material into the power cord. Do not touch the end of the power cord while it is plugged in.
- Keep the packing anti-moisture material or vinyl packing out of the reach of children. Anti-moisture material is harmful if swallowed. If swallowed, induce vomiting and go to the nearest hospital. Additionally, vinyl packing can cause suffocation. Keep it out of the reach of children.
- Concerning the Power Cord (Can differ by country): Check the specification page of this owner's manual to be certain concerning current requirements. Do not connect too many devices to the same AC power outlet as this could result in fire or electric shock. Do not overload wall outlets. Overloaded wall outlets, loose or damaged wall outlets, extension cords, frayed power cords, or damaged or cracked wire insulation are dangerous. Any of these conditions could result in electric shock or fire. Periodically examine the cord of your device, and if its appearance indicates damage or deterioration, unplug it, discontinue use of the device, and have the cord replaced with an exact replacement part by an authorized servicer. Protect the power cord from physical or mechanical abuse, such as being twisted, kinked, pinched, closed in a door, or walked upon. Pay particular attention to plugs, wall outlets, and the point where the cord exits the device. Do not move the TV with the power cord plugged in. Do not use a damaged or loose power cord. Be sure to grasp the plug when unplugging the power cord. Do not pull on the power cord to unplug the TV.

- Do not use this apparatus near water.
- Clean only with dry cloth.
- Do not block any ventilation openings. Install in accordance with the manufacturer's instructions.
- Do not install near any heat sources such as radiators, heat registers, stoves, or other apparatus (including amplifiers) that produce heat.
- Do not defeat the safety purpose of the polarized or grounding-type plug. A polarized plug has two blades with one wider than the other. A grounding type plug has two blades and a third grounding prong. The wide blade or the third prong are provided for your safety. If the provided plug does not fit into your outlet, consult an electrician for replacement of the obsolete outlet.
- Protect the power cord from being walked on or pinched particularly at plugs, convenience receptacles, and the point where they exit from the apparatus.
- Only use attachments/accessories specified by the manufacturer.

WARNING: This product contains chemicals known to the State of California to cause cancer and birth defects or other reproductive harm.

Wash hands after handling.

- To reduce the risk of fire or electrical shock, do not expose this product to rain, moisture or other liquids. Do not touch the TV with wet hands. Do not install this product near flammable objects such as gasoline or candles, or expose the TV to direct air conditioning.
- Do not use high voltage electrical equipment near the TV (e.g., a bug zapper). This may result in product malfunction.
- Do not expose to dripping or splashing and do not place objects filled with liquids, such as vases, cups, etc. on or over the apparatus (e.g., on shelves above the unit).
- **Grounding**
(Except for devices which are not grounded.) Ensure that you connect the earth ground wire to prevent possible electric shock (i.e., a TV with a three-prong grounded AC plug must be connected to a three-prong grounded AC outlet). If grounding methods are not possible, have a qualified electrician install a separate circuit breaker. Do not try to ground the unit by connecting it to telephone wires, lightning rods, or gas pipes.
- As long as this unit is connected to the AC wall outlet, it is not disconnected from the AC power source even if the unit is turned off.
- Do not attempt to modify this product in any way without written authorization from LG Electronics. Unauthorized modification could void the user's authority to operate this product.
- **Outdoor Antenna Grounding**
(Can differ by country):
If an outdoor antenna is installed, follow the precautions below. An outdoor antenna system should not be located in the vicinity of overhead power lines or other electric light or power circuits, or where it can come in contact with such power lines or circuits as death or serious injury can occur. Be sure the antenna system is grounded to provide some protection against voltage surges and built-up static charges. Section 810 of the National Electrical Code (NEC) in the U.S.A. provides information with respect to proper grounding of the mast and supporting structure, grounding of the lead-in wire to an antenna discharge unit, size of grounding conductors, location of antenna discharge unit, connection to grounding electrodes and requirements for the grounding electrode.
Antenna grounding according to the National Electrical Code, ANSI/NFPA 70
- **Moving**
Make sure the product is turned off, unplugged, and all cables have been removed. It may take 2 or more people to carry larger TVs. Do not press or put stress on the front panel of the TV.
- **Ventilation**
Install your TV where there is proper ventilation. Do not install in a confined space such as a bookcase. Do not cover the product with cloth or other materials while plugged. Do not install in excessively dusty places.
- Take care not to touch the ventilation openings. When watching the TV for a long period, the ventilation openings may become hot. This does not affect the performance of the product or cause defects in the product.
- If you smell smoke or other odors coming from the TV, unplug the power cord and contact an authorized service center.
- If water or another substance enters the product (like an AC adapter, power cord, or TV), disconnect the power cord and contact the service center immediately. Otherwise, this may result in fire or electric shock.
- Do not install this product on a wall if it could be exposed to oil or oil mist. This may damage the product and cause it to fall.
- Use only an authorized AC adapter and power cord approved by LG Electronics. Otherwise, this may result in fire, electric shock, malfunction, or product deformation.
- Never disassemble the AC adapter or power cord. This may result in fire or electric shock.
- Handle the adapter carefully to avoid dropping or striking it. An impact could damage the adapter.
- Keep the product away from direct sunlight.
- Never touch this apparatus or antenna during a lightning storm.
- When mounting a TV on the wall, make sure not to install the TV by hanging the power and signal cables on the back of the TV.
- Do not allow an impact shock, any objects to fall into the product, and do not drop anything onto the screen.

- **DISCONNECTING THE DEVICE FROM THE MAIN POWER**

The power plug is the disconnecting device. In case of an emergency, the power plug must remain readily accessible.

- Make sure the power cord is connected securely to the power plug on the TV.

- **Batteries**

Store the accessories (battery, etc.) in a safe location out of the reach of children.

- This apparatus uses batteries. In your community there might be regulations that require you to dispose of these batteries properly due to environmental considerations. Please contact your local authorities for disposal or recycling information.
- Do not dispose of batteries in a fire.
- Do not short circuit, disassemble, or allow the batteries to overheat.

- **Cleaning**

When cleaning, unplug the power cord and wipe gently with a soft cloth to prevent scratching. Do not spray water or other liquids directly on the TV as electric shock may occur. Do not clean with chemicals such as alcohol, thinners, or benzene.

Preparing

- Image shown may differ from your TV.
- Your TV's OSD (On Screen Display) may differ slightly from that shown in this manual.
- The available menus and options may differ from the input source or product model that you are using.
- New features may be added to this TV in the future.
- The items supplied with your product may vary depending upon the model.
- Product specifications or contents of this manual may be changed without prior notice due to upgrade of product functions.
- For an optimal connection, HDMI cables and USB devices should have bezels less than 10 mm (0.39 inches) thick and 18 mm (0.7 inches) width.
- Use an extension cable that supports USB 2.0 if the USB cable or USB flash drive does not fit into your TV's USB port.
- Use a certified cable with the HDMI logo attached. If you do not use a certified HDMI cable, the screen may not display or a connection error may occur.

- Recommended HDMI cable types
 - High-Speed HDMI®/™ cable
 - High-Speed HDMI®/™ cable with Ethernet

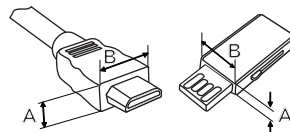

*A ≤ 10 mm (0.39 inches)

*B ≤ 18 mm (0.7 inches)

- Do not use any unapproved items to ensure the safety and lifespan of the product.
- Any damages or injuries by using unapproved items are not covered by the warranty.
- Some models appear to have a thin film on the screen. It is actually part of the screen; do not remove it.
- When attaching the stand to the TV set, place the screen facing down on a cushioned table or flat surface to protect the screen from scratches.
- Make sure that the screws are fastened tightly. (If they are not fastened securely enough, the TV may tilt forward after being installed.)
- Do not fasten the screws with excessive force otherwise they may be worn out and become loose.

Lifting and Moving the TV

When moving or lifting the TV, read the following to prevent the TV from being scratched or damaged and for safe transportation regardless of its type and size.

- It is recommended to move the TV in the box or packing material that the TV originally came in.
- Before moving or lifting the TV, disconnect the power cord and all cables.

- When holding the TV, the screen should face away from you to avoid damage.



- Hold the top and bottom of the TV frame firmly. Make sure not to hold the transparent part, speaker, or speaker grille area.

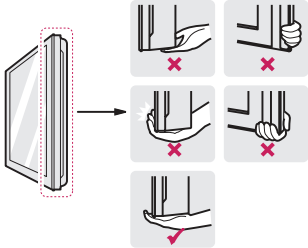

- Use at least two people to move a large TV.
- When transporting the TV by hand, hold the TV as shown in the following illustration.

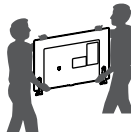

- When transporting the TV, do not expose the TV to jolts or excessive vibration.
- When transporting the TV, keep the TV upright; never turn the TV on its side or tilt towards the left or right.
- When handling the TV, be careful not to damage the protruding buttons.



- Avoid touching the screen at all times, as this may result in damage to the screen.
- Do not place the product on the floor with its front facing down without padding. Failure to do so may result in damage to the screen.
- Do not move the TV by holding the cable holders, as the cable holders may break, and injuries and damage to the TV may occur. (Depending upon model)

Using the Button

You can operate the TV by pressing the button.

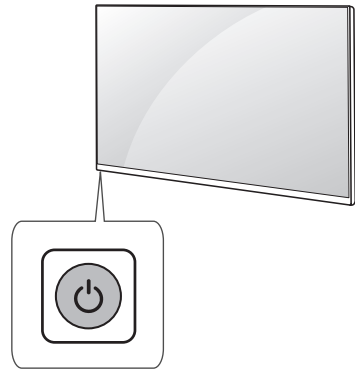

Basic Functions



Mounting on a Table

- 1 Lift and tilt the TV into its upright position on a table.
 - Leave a 10 cm (4 inches) (minimum) space from the wall for proper ventilation.

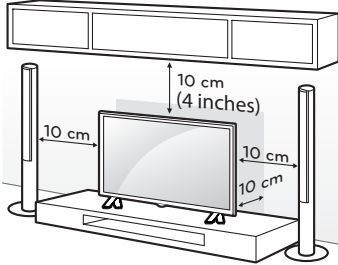

- 2 Connect the power cord to a wall outlet.



- Do not apply foreign substances (oils, lubricants, etc.) to the screw parts when assembling the product. (Doing so may damage the product.)

Securing the TV to a Wall (optional)

(Depending upon model)

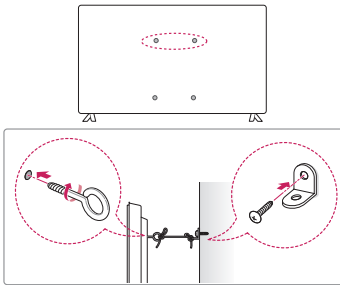

- 1 Insert and tighten the eye-bolts or TV brackets and bolts on the back of the TV.
 - If there are bolts inserted at the eye-bolts position, remove the bolts first.
- 2 Mount the wall brackets with the bolts to the wall. Match the location of the wall bracket and the eye-bolts on the rear of the TV.
- 3 Connect the eye-bolts and wall brackets tightly with a sturdy rope or cable. Make sure to keep the rope parallel to the flat surface.



- Make sure that children do not climb on or hang on the TV.
- Use a platform or cabinet that is strong and large enough to support the TV securely.
- Brackets, bolts, and ropes are optional. You can obtain additional accessories from your local dealer.

Mounting on a Wall

An optional wall mount can be used with your LG Television. Consult with your local dealer for a wall mount that supports the VESA standard used by your TV model. Carefully attach the wall mount bracket at the rear of the TV. Install the wall mount bracket on a solid wall perpendicular to the floor. If you are attaching the TV to other building materials, please contact qualified personnel to install the wall mount. Detailed instructions will be included with the wall mount. We recommend that you use an LG brand wall mount. The LG wall mount is easy to adjust or to connect the cables. When you do not use LG's wall mount bracket, use a wall mount bracket where the device is adequately secured to the wall with enough space to allow connectivity to external devices. If you are using a non-adjustable mount, attach the mount to the wall. Attach the cables to the TV first, then attach the TV to the mount.

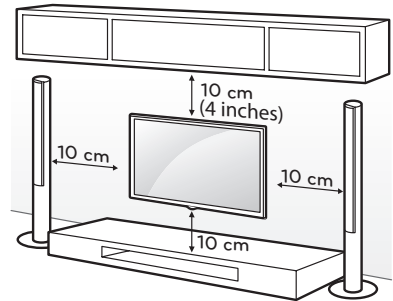

Make sure to use screws and wall mounts that meet the VESA standard. Standard dimensions for the wall mount kits are described in the following table.

Model	32LJ500B	43LJ5000 43LJ500M
VESA (A x B)	100 x 100	200 x 200
Standard screw	M4	M6
Number of screws	4	4
Wall mount bracket (optional)	LSW140B	LSW240B MSW240

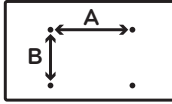

- Remove the stand before installing the TV on a wall mount by performing the stand attachment in reverse.

Connections (Notifications)

You can connect various external devices to the TV. Supported external devices are: HD receivers, DVD players, VCRs, audio systems, USB storage devices, PC, gaming devices, and other external devices. For more information on external device's connection, refer to the manual provided with each device.

- If you record a TV program on a DVD recorder or VCR, make sure to connect the TV signal input cable to the TV through a DVD recorder or VCR. For more information about recording, refer to the manual provided with the connected device.
- The external device connections shown may differ slightly from illustrations in a manual.
- Connect external devices to the TV regardless about the order of the TV port.
- If you connect a gaming device to the TV, use the cable supplied with the gaming device.
- Refer to the external equipment's manual for operating instructions.

Connecting to an Antenna or Cable

Connect an antenna, cable, or cable box to watch TV while referring to the following. The illustrations may differ from the actual items and an RF cable is optional.

- Make sure not to bend the copper wire of the RF cable.

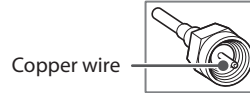

- Complete all connections between devices, and then connect the power cord to the power outlet to prevent damage to your TV.
- Use a signal splitter to use 2 TVs or more.
- DTV Audio Supported Codec: MPEG, Dolby Digital, HE-AAC

Other Connections

Connect your TV to external devices. For the best picture and audio quality, connect the external device and the TV with the HDMI cable.

- HDMI Audio Supported Format:
AC3 (32 kHz / 44.1 kHz / 48 kHz),
PCM (32 kHz / 44.1 kHz / 48 kHz / 96 kHz)
(Depending upon model)

Remote Control

(Some buttons and services may not be provided depending upon models or regions.)

The descriptions in this manual are based on the buttons on the remote control. Please read this manual carefully and use the TV correctly. To install batteries, open the battery cover, replace batteries (1.5 V AAA) matching the ⊕ and ⊖ ends to the label inside the compartment, and close the battery cover. Failure to match the correct polarities of the battery may cause the battery to burst or leak, resulting in fire, personal injury, or ambient pollution. To remove the batteries, perform the installation actions in reverse. This remote uses infrared light. When in use, it should be pointed in the direction of the TV's remote sensor.



A

- Power** Turns the TV on or off.
- TV** Returns to the last TV channel.
- CAPTION** Activates or deactivates the subtitles.
- INFO** Shows information on the current program.
- RATIO** Resizes an image.
- Input** Shows information on the current program.
- Number button** Enters numbers.
- (Dash)** Inserts a dash between numbers such as 2-1 and 2-2.
- LIST** Accesses the saved channel list.

FLASHBK Alternates between the two last channels selected (pressing repeatedly).

+ VOL - Adjusts the volume level.

FAV Accesses your favorite channel list.

AUDIO Digital signal: Changes the audio language.
Analog signal: Changes the MTS sound.

Mute Mutes all sounds.

CH Scrolls through the saved channels.

PAGE Moves to the previous or next screen.



B

- PICTURE** Changes the picture mode.
- Home** Accesses the Home menu.
- SOUND** Changes the sound mode.
- Settings** Accesses the setting menu.
- Q.MENU** Accesses the quick menu.
- Navigation button** (up / down / left / right) Scrolls through menus or options.
- OK** Selects menus or options and confirms your input.
- BACK** Returns to the previous screen.
- EXIT** Clears all on-screen displays and returns to TV viewing.
- SAP/*** Enables SAP (Secondary Audio Program) Feature.

SLEEP Sets the length of time until the TV to turns off.

■, ◀, ▶, ||, ▶▶ Control buttons for media contents

⋮, ⋮⋮, ⋮⋮⋮ These access special functions in some menus.

Settings

To select Picture Mode

⚙️ (Settings) ▶ Picture ▶ Picture Mode Settings ▶ Picture Mode

Select the picture mode optimized for the viewing environment or the program.

- **Vivid** Heightens contrast, brightness, and sharpness to display vivid images.
- **Standard** Displays images in standard levels of contrast, brightness and sharpness.
- **Cinema / Game** Displays the optimum picture for movie or game.
- **Sports** Optimised picture mode for football matches. The pitch and kits are presented in vibrant colours, with crystal-clear images even for fast movements.
- Depending upon the input signal, the available range of picture modes may differ.

Setting the Picture Mode

⚙️ (Settings) ▶ Picture ▶ Picture Mode Settings

This feature allows you to adjust the selected picture mode in detail.

- **Backlight** Controls the level of screen brightness by adjusting the backlight. The closer to 100, the brighter the screen. Decrease the Backlight to reduce energy consumption.
- **Contrast** Adjusts the contrast of the bright and dark areas of the picture. The closer to 100, the higher the contrast.
- **Brightness** Adjusts the overall screen brightness. The closer to 100, the brighter the screen.
- **Sharpness** Adjusts the sharpness of the image. The closer to 50, the sharper and clearer the image.
- **Color** Tones down or up the colors displayed on the screen. The closer to 100, the deeper the color.

- **Tint** Adjusts the color balance between red and green displayed on the screen. The closer to Red 50, the more red the color will be. The closer to Green 50, the more green the color will be.
- **Color Temperature** Adjusts the overall tone of the screen as desired. In Expert mode, detailed fine-tuning can be set via Gamma method, etc.
- The settings you specify only applies to the currently selected input mode. To apply your current picture settings to all input modes, select **Apply to all inputs**.
- Depending upon input signal or other picture settings, the range of detailed items for adjustment may differ.

To set expert control

⚙️ (Settings) ▶ Picture ▶ Picture Mode Settings ▶ Expert Controls

For each picture mode, the screen can be calibrated; or for a special screen, picture settings can be adjusted. Select the desired **Picture Mode**.

- **Dynamic Contrast** Adjusts the contrast to the optimal level according to the image's brightness.
- **Dynamic Color** Adjusts colors to make the image appear in more natural colors.
- **Gamma** Sets the gradation curve according to the output of picture signal in relation to the input signal.
- Depending upon input signal or other picture settings, the range of detailed items for adjustment may differ.

To set additional picture options

⚙️ (Settings) ▶ Picture ▶ Picture Mode Settings ▶ Picture Options

Adjusts detailed setting for images.

- **Noise Reduction** Eliminates noise in the picture.
- **MPEG Noise Reduction** Eliminates noise generated while creating digital picture signals.
- **Black Level** Adjusts the brightness and contrast of the screen to suit the black level.
- **Real Cinema** Optimizes the screen for movie viewing.
- Depending upon input signal or other picture settings, the range of detailed items for adjustment may differ.

Initializing picture settings

⚙️ (Settings) ▶ Picture ▶ Picture Mode Settings ▶ Picture Reset

Initializes picture settings that the user customizes.

Each picture mode is reset. Select the desired picture mode to reset.

Setting the Screen Size

⚙️ (Settings) ▶ Picture ▶ Aspect Ratio

Selects the screen aspect ratio.

- **16:9** Displays an aspect ratio of 16:9.
- **Original** Changes the aspect ratio to 4:3 or 16:9 depending upon the input video signal.
- **4:3** Displays an aspect ratio of 4:3.
- **Zoom** Resizes the image to fit the screen width. The top and bottom parts of the image may be cut off.
- **Just Scan** Displays video images in the original size without removing parts of the edge of the image. (This function works in DTV/Component/HDMI (720p / 1080i / 1080p) Mode.)
 - If you select **Just Scan**, you may see image noises at the edge of the original signal.
- Viewing content from an external device or, for an extended period of time, having fixed text such as the program name or using an aspect ratio of 4:3 may result in image sticking.
- Available picture size may differ depending on the input signal.

To use Energy Saving Feature

⚙️ (Settings) ▶ Picture ▶ Energy Saving

Reduces power consumption by adjusting peak screen brightness.

- **Off** Turns off the Energy Saving.
- **Minimum / Medium / Maximum** Applies the pre-set Energy Saving.
- **Screen Off** Screen is turned off and only sound is played. Press any button on the remote control to turn the screen back on.

To use picture test

⚙️ (Settings) ▶ Picture ▶ Picture Test

Conducts Picture Test first to verify that image signal output is normal. When the test image is normal, check connected external devices or broadcast signal.

Selecting Sound Mode

⚙️ (Settings) ▶ Sound ▶ Sound Mode Settings ▶ Sound Mode

Adjusts TV audio to an optimal level based on a selected sound mode.

- **Standard** Optimizes the sound for all types of content.
- **Cinema** Optimizes the sound for cinemas.
- **Sports** Optimizes the sound for sports.
- **Music** Optimizes the sound for music.
- **Game** Optimizes the sound for gameplay.

To adjust audio balance

⚙️ (Settings) ▶ Sound ▶ Sound Mode Settings ▶ Balance

Adjust the volume of the left and right speakers.

Using the Sound Effect function

⚙️ (Settings) ▶ Sound ▶ Sound Mode Settings

The user can select various sound effects.

- **Treble** Controls the dominant sounds in the output. When you turn up the treble, it will increase the output to the higher frequency range.
- **Bass** Controls the softer sounds in the output. When you turn up the bass, it will increase the output to the lower frequency range.
- **Reset** Reset the sound effect settings.
- This is only available if **Sound Mode** is set to **Standard**.

To set Auto Volume

⚙️ (Settings) ▶ Sound ▶ Auto Volume

Sets **Auto Volume** to **On** and volume output from channel to channel is automatically adjusted for convenient TV watching when clicking through different channels.

To use sound test

⚙️ (Settings) ▶ Sound ▶ Sound Test

Try Sound Test to verify that sound signal output is normal. When the test sound is normal, check connected external devices or broadcast signal.

To set up the channels automatically

⚙️ (Settings) ▶ Channels ▶ Auto Tuning

Memorizes automatically the channels being broadcast.

- The channels will not be memorized properly if the antenna/cable is not installed correctly.
- **Auto Tuning** memorizes the channels that are currently being broadcast.
- If **Lock System** is turned on, a pop-up window will appear asking for password.

To set up the channels at manually

⚙️ (Settings) ▶ Channels ▶ Manual Tuning

Adjusts channels manually and saves the results. For digital broadcasting, signal strength, etc. can be checked.

Editing the channels

⚙️ (Settings) ▶ Channels ▶ Channel Manager

Edits the saved channels.

To set Language

⚙️ (Settings) ▶ General ▶ Language

You can select the language of the menu displayed on the screen and the digital sound broadcasting.

- **Menu Language** Selects a language for the display text.
- **Audio Language** [In Digital mode Only] Selects the desired language when watching digital broadcasting containing several voice languages.

To set current time

⚙️ (Settings) ▶ General ▶ Time & Date ▶ Set Automatically

Checks or changes the time while watching TV.

- Synchronizes the TV clock to the digital time information sent by the TV station.
- **Time / Date / Time Zone** Sets the time and date manually if the auto setup does not correspond to the current time or region.
- **Daylight Saving** Daylight Saving Time refers to the practice of setting the clocks forward one hour from standard time during the summer months.

To use Sleep Timer

⚙️ (Settings) ▶ General ▶ Timers ▶ Sleep Timer

Turns off the TV after a prescribed number of minutes.

- To deactivate the **Sleep Timer**, select **Off**.

To turn on/off the TV

⚙️ (Settings) ▶ General ▶ Timers ▶ Timer Power On / Timer Power Off

You can set the Power On/Off time for the TV.

- Select **Off** if you are not going to set **Timer Power On / Timer Power Off**.
- To set **Timer Power On / Timer Power Off**, set the current time correctly.

Requesting service

⚙️ (Settings) ▶ General ▶ About This TV

For information on requesting service, refer to the TV's menu.

To set Power Indicator

⚙️ (Settings) ▶ General ▶ Standby Light

Turns on/off the standby light in the front panel of the TV.

To change the TV Mode

⚙️ (Settings) ► General ► Home/Store Mode

Selects **Home Mode** or **Store Mode**.

- When in use in home, please select **Home Mode**.
- **Store Mode** is for store display.

To return to initial settings

⚙️ (Settings) ► General ► Reset to Initial Settings

Returns to initial default mode by deleting all optional setup. Once initialization is completed, the TV will turn off and on by itself.

- When **Lock System** is in place, a pop-up window appears and asks for password.
- Do not turn off the power during initialization.

To set the password

⚙️ (Settings) ► Safety ► Set Password

Set or change the TV password.

- The initial password is set to **0000**.

To set the Lock System

⚙️ (Settings) ► Safety ► Lock System

Permits only specific programs by blocking channels or external input.

At first, set **Lock System** to **On**.

- Set the movie and TV rating level by select relevant option from **Movie Lock**, **Children TV Program Locks** and **General TV Program Locks**. For downloadable videos, select **Downloadable Rating** to set up the rating level.
- A channel can be blocked by setting up **Channel Locks**.
- A input source can be blocked by setting up **Input Locks**.

To set the caption

⚙️ (Settings) ► Accessibility ► Closed Caption

View captions when the TV station provides captioned programming. Program captions work only on digital/analog broadcasts or external input.

Change **Closed Caption** to **On** and select caption settings.

• Mode

CC 1-4 (Closed Captioning) / **Text 1-4**: Displays the audio portion of a TV program as text on the TV screen. CC1 is the most common mode in use.

Field 1 data channels: two Captions (CC1, CC2), two Text (T1, T2).

Field 2 data channels: two Captions (CC3, CC4), two Text (T3, T4).

Service 1-6: This is only available for the digital broadcasting system.

- **Digital Mode Options**: Set up the size and color of the captions on **Digital Mode Options**. Please select **Set By Program** or **Custom**. Select **Custom** to adjust minute options such as the captions' size and color.

To use Audio Guidance

⚙️ (Settings) ► Accessibility ► Audio Guidance

When the Audio Guidance is set to On, the TV will announce its current status (Channel, Volume) by voice.

To remove the USB device

Q.MENU ► USB Device

Once the message that the USB device was removed is displayed, remove the device from the TV.

- After selecting to remove USB device, the USB storage device cannot be read. Remove the USB storage device and then reconnect it.

Warning when using USB storage devices

- USB storage devices with a built-in auto recognition program or its own driver may not work.
- Some USB storage devices may not work or may work improperly.
- Use only those USB storage devices formatted with FAT16, FAT32 or NTFS File System provided by Windows.
- For external USB HDD, use devices with less than 5V-rated voltages and 500 mA-rated current.
- It is recommended to use USB flash drive with 32 GB or less and USB HDD with 2 TB or less.
- If a USB HDD with power-saving function does not work properly, turn the power off and on. For more information, refer to the user manual of USB HDD.
- Data in the USB storage device can be damaged so back up important files in other devices. Data maintenance is the user's responsibility. The manufacturer is not responsible for data loss.

My Media Supported Files

- External supported subtitle formats:
.srt (SubRip), .ssa/.ass (SubStation Alpha),
.smi (SAMI), .sub (SubViewer1, MicroDVD,
DVDSubtitleSystem, Subldx(VobSub)), .txt
(TMPPlayer)
1 SubViewer 1.0 & 2.0 Only
- Internal supported subtitle formats:
.dat/.mpg/.mpeg/.vob (DVD Subtitle), .ts/.trp/.tp
(DVB Subtitle), .mp4 (DVD Subtitle, UTF-8 Plain
Text), .mkv (ASS, SSA, UTF-8 Plain Text, VobSub,
DVD Subtitle), .avi (XSUB, XSUB+)

Supported Photo Formats

- Category: .jpg
[Available file type] Progressive JPEG
[Photo size] Minimum: 2 x 2,
Maximum: 1,024 (W) x 768 (H)
- Category: .jpeg
[Available file type] Baseline JPEG
[Photo size] Minimum: 2 x 2,
Maximum: 15,360 (W) x 8,640 (H)
- Category: .bmp
[Available file type] BMP
[Photo size] Minimum: 2 x 2,
Maximum: 9,600 x 6,400
[Pixel Depth] 1/4/8/16/24/32 bpp
- Category: .png
[Available file type] Interlaced, Non-Interlaced
[Photo size] Minimum: 2 x 2, Maximum:
Interlaced: 1,200 x 800, Non-Interlaced: 9,600 x
6,400
- BMP and PNG format files may be slower to
display than JPEG, especially in high resolution.

Supported Audio Formats

- File type: .mp3
[Bit rate] 32 Kbps - 320 Kbps
[Sample freq.] 16 kHz - 48 kHz
[Support] MPEG1/2/2.5 Layer3
- File type: .ac3
[Bit rate] 32 Kbps - 640 Kbps
[Sample freq.] 32 kHz, 44.1 kHz, 48 kHz
[Support] AC3
- File type: .m4a, .aac
[Sample freq.] 8 kHz - 48 kHz
[Support] AAC
- File type: .flac
[Bit rate] < 1.6 Mbps
[Sample freq.] 8 kHz - 48 kHz
[Support] FLAC
- File type: .wav
[Bit rate] 64 Kbps - 1.5 Mbps
[Sample freq.] 8 kHz - 48 kHz
[Support] PCM
- When moving to a folder containing videos
while playing music, the music may stop playing.

Supported Video Formats

- Maximum: 1,920 x 1,080p @ 30p (only Motion
JPEG 640 x 480 @ 30p)
- .mpg, .mpeg
[Video] MPEG-1, MPEG-2, MPEG-4
[Audio] MPEG1/2/2.5 Layer3, AC3, AAC, LPCM
- .avi
[Video] MJPEG, MPEG-4, H.263, XViD, H.264,
MPEG-1, MPEG-2
[Audio] MPEG1/2/2.5 Layer3, AC3, AAC, LPCM
- .ts
[Video] MPEG-2, H.264, HEVC
[Audio] MPEG1/2/2.5 Layer3, AC3, AAC, LPCM
- .mov, .mkv
[Video] MPEG-4, H.263, H.264, HEVC, MPEG-1,
MPEG-2, XViD
[Audio] MPEG1/2/2.5 Layer3, AC3, AAC, LPCM
- .dat
[Video] MPEG-1, MPEG-2
[Audio] MPEG1/2/2.5 Layer3, AC3, AAC, LPCM
- .mp4
[Video] MPEG-4, H.264, MPEG-1, MPEG-2
[Audio] MPEG1/2/2.5 Layer3, AC3, AAC, LPCM
- .vob
[Video] MPEG-1, MPEG-2
[Audio] MPEG1/2/2.5 Layer3, AC3, AAC, LPCM
- .3gp
[Video] H.264, MPEG-4
[Audio] MPEG1/2/2.5 Layer3, AC3, AAC, LPCM
- .flv
[Video] H.264
[Audio] MPEG1/2/2.5 Layer3, AC3, AAC, LPCM
- Some codecs may not be supported depending
on model.
- Some subtitles created by users may not work
properly.
- The video and subtitle files should be placed in
the same folder. Assign the same names to the
video and subtitle files for proper display.
- Streams containing GMC (Global Motion
Compensation) or Qpel (Quarterpel Motion
Estimation) are not supported.
- Only H.264/AVC profile levels 4.1 and lower are
supported.
- Video files that exceed 50 GB (Gigabyte) are
not supported for playback. The file size limit is
dependent on the encoding environment.
- [This feature is available on certain models only.]
The DTS is supported only for playback of USB
and HDMI video files.
- The DTS support may vary depending on your
country and model.

Licenses

Supported licenses may differ by model. For more information about licenses, visit www.lg.com.



Manufactured under license from Dolby Laboratories.

Dolby, Dolby Vision, Dolby Audio, and the double-D symbol are trademarks of Dolby Laboratories.



The terms HDMI and HDMI High-Definition Multimedia Interface, and the HDMI Logo are trademarks or registered trademarks of HDMI Licensing LLC in the United States and other countries.

Troubleshooting

- Cannot control the TV with the remote control.
 - Check if anything such as tape has been placed over the receiver.
 - Check if there is any obstacle between the product and the remote control.
 - Replace the batteries with new fresh ones.
- No image display and no sound is produced.
 - Check if the product is turned on.
 - Check if the power cord is connected to a wall outlet.
 - Check if there is a problem in the wall outlet by connecting other products.
- The TV turns off suddenly.
 - Check the power control settings. The power supply may be interrupted.
 - Check if the **Sleep Timer / Timer Power Off** feature is activated in the **Timers** settings.
 - If there is no signal while the TV is on, the TV will turn off automatically after 15 minutes of inactivity.
- **Abnormal Display**
 - If the TV feels cold to the touch, there may be a small flicker when it is turned on. This is normal; there is nothing wrong with TV. Some minute dot defects may be visible on the screen, appearing as tiny red, green, or blue spots. However, they have no adverse effect on the TV's performance. Avoid touching the LCD screen or holding your finger(s) against it for long periods of time. Doing so may produce some temporary distortion effects on the screen.
 - This panel is an advanced product that contains millions of pixels. In a very few cases, you could see fine dots on the screen while you're viewing the TV. Those dots are deactivated pixels and do not affect the performance and reliability of the TV.
 - Displaying a still image for a prolonged period of time may cause an image sticking. Avoid displaying a fixed image on the TV screen for a extended length of time.
- **Generated Sound**
 - **Cracking noise** A cracking noise that occurs when watching or turning off the TV is generated by plastic thermal contraction due to temperature and humidity. This noise is common for products where thermal deformation is required.
 - **Electrical circuit humming/panel buzzing** A low level noise is generated from a high-speed switching circuit, which supplies a large amount of current to operate a product. It varies depending upon the product. This generated sound does not affect the performance and reliability of the product.

Specifications

Product specifications may be changed without prior notice due to upgrade of product functions.

Estimated yearly energy consumption indicated on the FTC label is measured in accordance with the Test Procedures for Television Sets (USA only).

The actual energy consumption depends on the usage environment (The content watched, TV settings, etc.).

Television System

NTSC-M, ATSC, 64 & 256 QAM

Program Coverage

VHF 2-13, UHF 14-69, DTV 2-69, CATV 1-135, CADTV 1-135

External Antenna Impedance

75 Ω

Environment condition

- **Operating Temperature**
0 °C to 40 °C (32 °F to 104 °F)
- **Operating Humidity**
Less than 80 %
- **Storage Temperature**
-20 °C to 60 °C (-4 °F to 140 °F)
- **Storage Humidity**
Less than 85 %

HDMI (PC) supported mode

(Use HDMI IN 1 for PC mode)

Resolution	Horizontal Frequency (kHz)	Vertical Frequency (Hz)
720 x 400	31.469	70.00
640 x 480	31.469	59.94
800 x 600	35.156	56.25
	37.879	60.317
1024 x 768	48.363	60.004
1280 x 720	45.00	60.00
1280 x 768	47.776	59.87
1366 x 768	49.10	60.00
1280 x 960	60.00	60.00
1280 x 1024	63.90	60.00
1280 x 800	49.50	59.80
1680 x 1050	65.20	59.90
1920 x 1080	67.50	60.00

■ For 43LJ5000, 43LJ500M

HDMI (DTV) supported mode

Resolution	Horizontal Frequency (kHz)	Vertical Frequency (Hz)
640 x 480p	31.47	59.94
	31.50	60.00
720 x 480p	31.47	59.94
	31.50	60.00
1280 x 720p	37.50	50.00
	44.96	59.94
	45.00	60.00
720 (1440) x 480i	15.73	59.94
	15.75	60.00
720 x 576p	31.25	50.00
720 (1440) x 576i	15.63	50.00
1920 x 1080i	28.125	50.00
	33.72	59.94
	33.75	60.00
1920 x 1080p	26.97	23.976
	27.00	24.00
	33.716	29.976
	33.75	30.00
	56.25	50.00
	67.432	59.94
	67.50	60.00

Component port connecting information

Component ports on the TV	Y	P _B	P _R
---------------------------	---	----------------	----------------

Video output ports on DVD player	Y	P _B	P _R
	Y	B-Y	R-Y
	Y	Cb	Cr
	Y	Pb	Pr

Component supported mode

Resolution	Horizontal Frequency (kHz)	Vertical Frequency (Hz)
720 x 480i	15.73	60.00
720 x 480p	31.50	60.00
1440 x 576i	16.63	50.00
720 x 576p	31.50	50.00
1280 x 720p	37.50	50.00
	45.00	60.00
1920 x 1080i	28.13	50.00
	33.75	60.00
1920 x 1080p	56.25	50.00
	67.50	60.00

Regulatory

FCC NOTICE

(For USA)

This equipment has been tested and found to comply with the limits for a Class B digital device, pursuant to Part 15 of the FCC Rules. These limits are designed to provide reasonable protection against harmful interference in a residential installation. This equipment generates, uses and can radiate radio frequency energy and, if not installed and used in accordance with the instructions, may cause harmful interference to radio communications. However, there is no guarantee that interference will not occur in a particular installation. If this equipment does cause harmful interference to radio or television reception, which can be determined by turning the equipment off and on, the user is encouraged to try to correct the interference by one or more of the following measures:

- Reorient or relocate the receiving antenna.
- Increase the separation between the equipment and the receiver.
- Connect the equipment to an outlet on a circuit different from that to which the receiver is connected.
- Consult the dealer or an experienced radio/TV technician for help.

This device complies with part 15 of the FCC Rules. Operation is subject to the following two conditions: (1) this device may not cause harmful interference and (2) this device must accept any interference received, including interference that may cause undesired operation of the device. Any changes or modifications in construction of this device which are not expressly approved by the party responsible for compliance could void the user's authority to operate the equipment.

FCC Radio Frequency Interference Requirements (for UNII devices)

High power radars are allocated as primary users of the 5.25 to 5.35 GHz and 5.65 to 5.85 GHz bands. These radar stations can cause interference with and/or damage this device. This device cannot be co-located with any other transmitter.

FCC RF Radiation Exposure Statement

[For having wireless function (WLAN, Bluetooth,...)]

This equipment complies with FCC radiation exposure limits set forth for an uncontrolled environment. This transmitter must not be colocated or operating in conjunction with any other antenna or transmitter. This equipment should be installed and operated with minimum distance 20 cm (7.8 inches) between the radiator and your body. Users must follow the specific operating instructions for satisfying RF exposure compliance.

Industry Canada Statement

(For Canada)

[For having wireless function (WLAN, Bluetooth,...)]

This device complies with Industry Canada's applicable licence-exempt RSSs. Operation is subject to the following two conditions:

- (1) This device may not cause interference; and
- (2) This device must accept any interference, including interference that may cause undesired operation of the device.

IC Radiation Exposure Statement

(For Canada)

[For having wireless function (WLAN, Bluetooth,...)]

This equipment complies with IC radiation exposure limits set forth for an uncontrolled environment. This equipment should be installed and operated with minimum distance 20 cm (7.8 inches) between the antenna & your body.

NOTE : THE MANUFACTURER IS NOT RESPONSIBLE FOR ANY RADIO OR TV INTERFERENCE CAUSED BY UNAUTHORIZED MODIFICATIONS TO THIS EQUIPMENT. SUCH MODIFICATIONS COULD VOID THE USER'S AUTHORITY TO OPERATE THE EQUIPMENT.

(For Canada)

[For product having the wireless function using 5 GHz frequency bands]

- The device for operation in the band 5150–5250 MHz is only for indoor use to reduce the potential for harmful interference to co-channel mobile satellite systems;
- For devices with detachable antenna(s), the maximum antenna gain permitted for devices in the bands 5250-5350 MHz and 5470-5725 MHz shall be such that the equipment still complies with the e.i.r.p. limit;
- For devices with detachable antenna(s), the maximum antenna gain permitted for devices in the band 5725–5850 MHz shall be such that the equipment still complies with the e.i.r.p. limits specified for point-to-point and non-point-to-point operation as appropriate; and
- The worst-case tilt angle(s) necessary to remain compliant with the e.i.r.p. elevation mask requirement set forth in Section 6.2.2(3) shall be clearly indicated.(devices operating in the band 5250-5350 MHz with a maximum e.i.r.p. greater than 200 mW)
- High-power radars are allocated as primary users (i.e. priority users) of the bands 5250–5350 MHz and 5650–5850 MHz and that these radars could cause interference and/or damage to LE-LAN devices.

NOTE TO CABLE/TV INSTALLER

(For USA and Canada)

This reminder is provided to call the CATV system installer's attention to Article 820-40 of the National Electric Code (U.S.A.). The code provides guidelines for proper grounding and, in particular, specifies that the cable ground shall be connected to the grounding system of the building, as close to the point of the cable entry as practical.







WARNING!

Never place a television set in an unstable location. A television set may fall, causing serious personal injury or death. Many injuries, particularly to children, can be avoided by taking simple precautions such as:

- Using cabinets or stands recommended by the manufacturer of the television set.
- Only using furniture that can safely support the television set.
- Ensuring the television set is not overhanging the edge of the supporting furniture.
- Not placing the television set on tall furniture (for example, cupboards or bookcases) without anchoring both the furniture and the television set to a suitable support.
- Not placing the television set on cloth or other materials that may be located between the television set and supporting furniture.
- Educating children about the dangers of climbing on furniture to reach the television set or its controls.

If your existing television set is being retained and relocated, the same considerations as above should be applied.

Symbols

	Refers to alternating current (AC).
	Refers to direct current (DC).
	Refers to class II equipment.
	Refers to stand-by.
	Refers to "ON" (power).
	Refers to dangerous voltage.

LG Recycling Policy

(For USA)

LG Electronics offers a customized e-waste take-back and recycling service that meets local needs and requirements in the countries where e-waste regulations are in place, and also provides product and packaging take-back and recycling service voluntarily in some countries. LG Electronics evaluates products' recyclability at the design step using LG's recyclability evaluation tool, with the goal of improving recyclability where practicable. Through these activities, LG seeks to contribute to conserving natural resources and protecting the environment. For more information about the LG Recycling Policy, please visit our global site at <http://www.lg.com/global/sustainability/environment/take-back-recycling>

CHILD SAFETY:

PROPER TELEVISION PLACEMENT MATTERS



THE CONSUMER ELECTRONICS INDUSTRY CARES

- Manufacturers, retailers and the rest of the consumer electronics industry are committed to making home entertainment safe and enjoyable.
- As you enjoy your television, please note that all televisions – new and old- must be supported on proper stands or installed according to the manufacturer’s recommendations. Televisions that are inappropriately situated on dressers, bookcases, shelves, desks, speakers, chests, carts, etc., may fall over, resulting in injury.



TUNE IN TO SAFETY

- **ALWAYS** follow the manufacturer’s recommendations for the safe installation of your television.
- **ALWAYS** read and follow all instructions for proper use of your television.
- **NEVER** allow children to climb on or play on the television or the furniture on which the television is placed.
- **NEVER** place the television on furniture that can easily be used as steps, such as a chest of drawers.
- **ALWAYS** install the television where it cannot be pushed, pulled over or knocked down.
- **ALWAYS** route cords and cables connected to the television so that they cannot be tripped over, pulled or grabbed.



WALL OR CEILING MOUNT YOUR TELEVISION

- **ALWAYS** contact your retailer about professional installation if you have any doubts about your ability to safely mount your television.
- **ALWAYS** use a mount that has been recommended by the television manufacturer and has a safety certification by an independent laboratory (such as UL, CSA, ETL).
- **ALWAYS** follow all instructions supplied by the television and mount manufacturers.
- **ALWAYS** make sure that the wall or ceiling where you are mounting the television is appropriate. Some mounts are not designed to be mounted to walls and ceilings with steel studs or cinder block construction. If you are unsure, contact a professional installer.
- Televisions can be heavy. A minimum of two people is required for a wall or ceiling mount installation.



MOVING AN OLDER TELEVISION TO A NEW PLACE IN YOUR HOME

- Many new television buyers move their older CRT televisions into a secondary room after the purchase of a flat-panel television. Special care should be made in the placement of older CRT televisions.
- **ALWAYS** place your older CRT television on furniture that is sturdy and appropriate for its size and weight.
- **NEVER** place your older CRT television on a dresser where children may be tempted to use the drawers to climb.
- **ALWAYS** make sure your older CRT television does not hang over the edge of your furniture.



Declaration of Conformity

Trade Name	LG
Model	32LJ500B-UB, 43LJ5000-UB, 43LJ500M-UB
Responsible Party	LG Electronics Inc.
Address	1000 Sylvan Ave. Englewood Cliffs NJ 07632 U.S.A
TEL	201-266-2534

LG Customer Information Center

For inquires or comments, visit www.lg.com or call;

1-800-243-0000	USA, Consumer User
1-888-865-3026	USA, Commercial User
1-888-542-2623	CANADA

Register your product Online!

www.lg.com

The model and serial numbers of the TV are located on the back and on one side of the TV. Record them below should you ever need service.

MODEL _____

SERIAL _____