

A Smart Solution with ULTRA HD Display

Create the best in-room entertainment experience with LG's Pro:Centric® SMART IPTV. The UW660H series enable guests to connect portable devices and enjoy their own content through media share features, and provide commercial grade stand which improves comfort and security.



UW660H

- Pro:Centric® SMART
- ULTRA HD
- Integrated Pro:Idiom® Digital Rights Management Technology
- Commercial Grade Stand
- ^{NEW} Pro:Centric Direct Ready
- Media Share Features

screen size

43", 49", 55"

Key Features

Pro:Centric® SMART

The UW660H is the latest in the line of Pro:Centric TVs that provide a unique and dedicated hotel applications hosting platform for LG's system integrators' interactive applications, enabling delivery for a wide range of custom applications tailored to both hotel management and guest needs. LG Pro:Centric SMART offers extended customizable tools : HTML5, Java and Flash. Using these tools, partners can optimize the TVs by editing and developing their own enhanced service design. Also, it can optimize the TV features by developing custom enhanced service design that increases the visual impact on guests.

Pro:Idiom®

GLOBAL LEADING DIGITAL RIGHTS MANAGEMENT (DRM) SOLUTION

Pro:Idiom unlocks access to premium content to help ensure rapid and broad deployment of HDTV and other high value digital content.

Pro:Idiom has been designed specifically for users of premium HDTV content from cable, satellite, or video on demand (VOD) services, and is intended to lower costs and reduce maintenance. This leading DRM system is embraced for its security solution, prevents illegal copying of copyrighted content.

ULTRA HD TV

4K Resolution

4K ULTRA HD is the future of digital picture, possessing four times higher resolution than that of full HD. Stunning 8.3 million pixels gives a flawless picture quality and incredibly vivid detail.



4K Upscaler

Enjoy Full HD content in 4K ULTRA HD quality. The 4K Upscaler automatically upgrades Full HD content to ULTRA HD through the six steps of the upscaling processes.



4K IPS Wide Viewing Angle

One of the secrets behind outstanding viewing experience with LG TVs is the specially designed TV panel. 4K IPS delivers true colour from any angle with 4 times the resolution of Full HD. With 4K IPS, every seat is the best for watching content in your space.



A Smart Solution with ULTRA HD Display

Pro:Centric Application

Personalize the television experience with the Pro:Centric Application (PCA), which provides guests' access to a variety of additional features, such as an interactive Electronic Program Guide, weather forecast and radar map, and customized electronic billboards for information on hotel amenities, all conveniently presented through the on-screen menu.

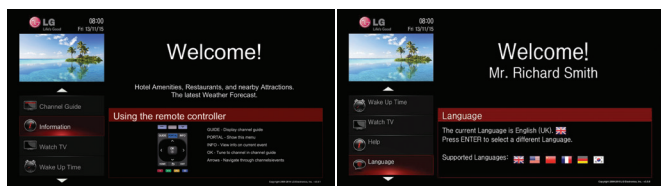

Welcome Page

Language Selection



Custom Billboards

EPG Option

Free Interactive EPG Service for Pro:Centric TVs

PLAN HIGHLIGHTS

If your property has purchased or plans to purchase LG's Pro:Centric TVs, you may qualify for a free EPG that allows guests to easily navigate TV channels and programs, just like they do at home. Participating properties must purchase and install a Pro:Centric server and supply an internet connection for daily program updates. Properties must also contract with an LG authorized partner to install and program the server to match your Free-To-Guest (FTG) Channel Map.

Free program guide service runs until December 2017, replacing the previous programming fee of \$1.50 per room per month.

Contact your LG sales representative or visit:
www.LG.com/us/commercial/display-discover/epg

PCS200S HEAD END SYSTEM



Remote management functions are supported via the Pro:Centric server. The Pro:Centric Application software can be remotely added at a later date to deliver the benefits of LG's Pro:Centric Application features. (Weather, EPG, Billboards, etc)

LG's FTG COST EFFECTIVE SOLUTION

When using LG televisions in FTG hotel installations, the Pro:Centric server (PCS200S) supports remote management of TV settings. With remote management, individual room visits are no longer required for TV configuration updates, including FTG Channel Map and FTG Installer Menu settings updates, thereby saving labor costs.

Hotel Costs For FTG Channel Management

	Estimated Labor Costs	MSRP	Total	Savings over room visit
LG Pro:Centric TV with Pro:Centric Server		\$2,499 (PCS200S)	\$2,499	\$17,501
Other brand	\$20(est.) x 2 times per year (to update channels) x 100 rooms x 5 years		\$20,000	

MSRP subject to change. Installation not included.

Pro:Centric Direct Ready

Simply create your own templates and remotely manage TVs on the IP network with Pro:Centric Direct, LG's content management software. Pro:Centric Direct offers a free design template, along with customizable widgets and three types of theme templates (Cinematic-type, Grid-type, Bar-type) in order to promote branding and provide useful information for guests. Its interactive feature, 1-Click service, and intuitive UI will impress guests by elevating their in-room experience. Plus, for hoteliers, not only does it offer efficient content production and management, it also maximizes advertisement effectiveness, which contributes to improving the hotel brand.

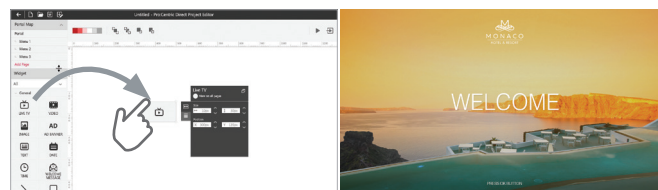

Free Design

Theme Option (Cinematic)

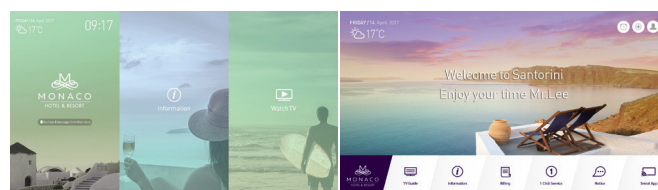

Theme Option (Grid)

Theme Option (Bar)

Smart Connectivity

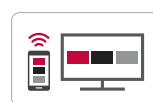

Media Share

Guests may use LG Smart Share features, such as Wi-Fi Direct®, as well as Screen Share features, including Miracast®, WiDi, and DIAL to view content from their mobile devices on the large HD screen.



Bluetooth Sound Sync

This feature allows guests to listen to audio from a Bluetooth-enabled mobile device through the TV's speakers.

A Smart Solution with ULTRA HD Display

Dimensions

43"

38.3" x 24.5" x 11.9"
(With Stand : W x H x D)

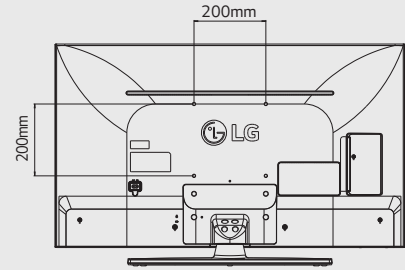
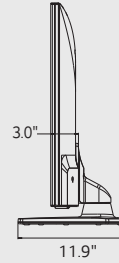
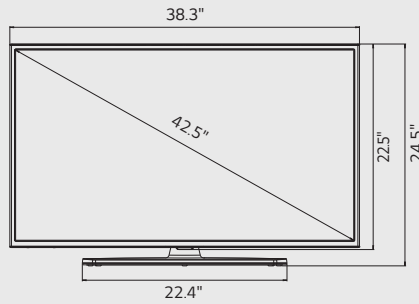

49"

43.5" x 27.3" x 11.9"
(With Stand : W x H x D)

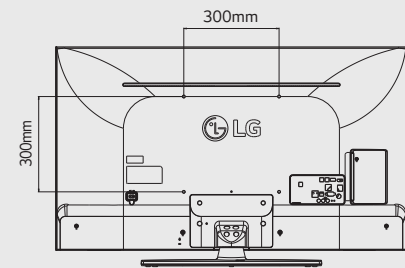
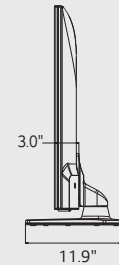
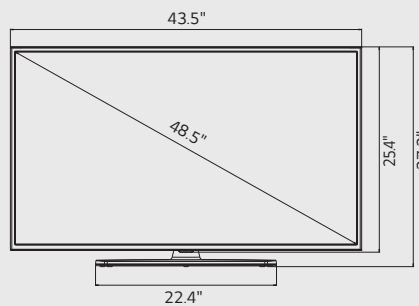

55"

48.8" x 30.3" x 11.9"
(With Stand : W x H x D)

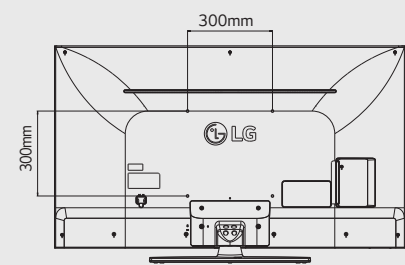
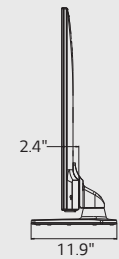
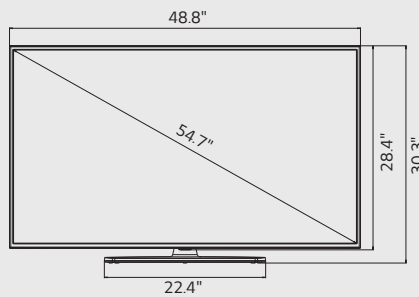

Jack Panels (Rear/Side)

- | | | |
|-----------------------------|---------------|--------------------------|
| 1 OPTICAL DIGITAL AUDIO OUT | 6 LAN | 11 AV IN / AUDIO IN |
| 2 SERVICE | 7 SPEAKER OUT | 12 ANTENNA / CABLE IN |
| 3 PTC SERVICE | 8 RJP | 13 HDMI IN 2 / HDMI IN 3 |
| 4 USB IN 1 | 9 RS-232C IN | 14 USB IN 2 |
| 5 HDMI IN 1 | 10 M.P.I. | |

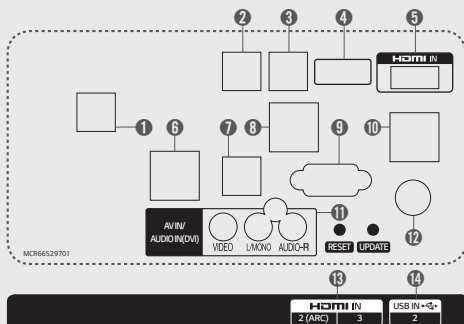

Anti-Theft System



Kensington Lock

- LG Hotel TVs are protected by the reliable Kensington Lock solution.



Reinforced Metal Stand

- Full metal reinforced stand to improve sturdiness, durability and safety.
- Provides (±20°) swivel out of the box.
- Provides (±20/45/90°) swivel when used with Lock Down plate.



Lock Down Plate with Credenza Hole

- Lock the TV firmly to the credenza for added security and help deter theft. (Mounting plate, security bolts, nuts and screws are included.)

Specifications

UW660H

		43	49	55
DISPLAY	Type	Direct LED		Edge LED
	Resolution	3,840 x 2,160 (UHD)		
	Dynamic Contrast Ratio	1,000,000 : 1		
	Static Contrast Ratio	1,100 : 1		
	Viewing Angle Degree	178° / 178°		
	Response Time (G to G)	9 m/s		
BROADCASTING SYSTEM	Frame Rate	60 Hz		
	Analog	NTSC		
	Digital	ATSC / VSB / Clear QAM		
VIDEO	MPEG-2 / MPEG-4 H.264 DECODING	•		
	Triple XD Engine	•		
	Real Cinema 24p (3:3 Pull down)	•		
	Dynamic Color Enhancer	•		
	Aspect Ratio	• 6 modes (16:9, Original, 4:3, Vertical Zoom, All-Direction Zoom, Just Scan)		
	UHD Contents Streaming Support	USB/IP/HDMI		
AUDIO	Tru 4K Upscaler	•		
	Audio Output / Speaker System	10W + 10W / 2.0 ch		
	Sound Mode	• 6 modes (Standard, Cinema, Clear Voice III, Sports, Music, Game)		
	Smart Sound Mode	•		
	Optical Sound Sync	•		
	Wireless Sound Sync	•		
GENERAL FEATURES	Pro:Centric®	Type	Pro:Centric Smart	
		Data Streaming (IP&RF)	•	
		Pro:Centric Application	PCA 3.7	
		RF	1 Tuner	
	HCAP (SDK)	GEM / Flash / HTML		
	Smart Features	Smart Share, DLNA, WiDi, Miracast, Wi-Fi Direct, DIAL, Bluetooth Sound Sync, SoftAP, Web Browser, Magic Remote (Optional)		
	Management	Remote Diagnostics / EZ-Manager Wizard (for Initial Configuration)		
	Interactivity	HTNG / HDMI-CEC		
	Digital Rights Management	Pro:Idiom		
	RJP Interface	RS-232C, HDMI		
	RJP Compatibility	•		
	USB Media	Moving Picture Playback (MPEG), Picture (JPEG), Audio Codec (AC3, EAC3, AAC, Mpeg, MP3, PCM)		
Advanced Setting Option	Auto Off/ Auto Sleep, Smart Energy Saving, Motion Eye Care			
Anti-theft System	Kensington Lock, Credenza/Security Screw Hole, Lock Down Plate, Commercial Grade Stand			
COMMERCIAL FEATURES	Welcome Screen (Splash Screen), FTG Mode, Instant On, IR Out, External Speaker Out, USB Cloning, Logical Channel Map, Multi-IR Code			
	Side			
INTERFACE	Side	HDMI In (2), USB 2.0		
	Rear	RF In, AV In, Optical Digital Audio Out, HDMI Input, USB 2.0, PC Audio Input (Sharing with AV In), RS-232C, LAN Port, RJP port, External Speaker Out, PTC Service Port, Service Port, MPI Port		
ACCESSORIES	Power Cable (5.9 ft), Owner's Manual / Easy Setup Guide			
DIMENSIONS	Bezel Width (L / R, U, B) : on bezel based	11.6mm, 14.1mm, 17.4mm	11.6mm, 14.1mm, 17.4mm	10.6mm, 13.1mm, 15.9mm
	Bezel Width (L / R, U, B) : off bezel based	9.3mm, 11.8mm, 15.1mm	9.3mm, 11.8mm, 15.1mm	8.1mm, 10.6mm, 13.4mm
	Vesa (mm)	200 x 200		
	WxHxD / weight (w/o stand)	38.3" x 22.5" x 3.0" / 20.5lb	43.5" x 25.4" x 3.0" / 26.0lb	48.8" x 28.4" x 2.4" / 35.9lb
	WxHxD / weight (with stand)	38.3" x 24.5" x 11.9" / 28.2lb	43.5" x 27.3" x 11.9" / 33.7lb	48.8" x 30.3" x 11.9" / 43.6lb
	WxHxD / weight (Carton)	45.2" x 28.7" x 6.9" / 34.0lb	51.2" x 30.5" x 6.9" / 42.1lb	53.5" x 33.9" x 7.5" / 54.7lb
POWER	Stand	(±20/45/90°) Swivel		
	Voltage, Hz	100 ~ 240V, 50/60Hz		
	Typical (Watts)	54.6	65.4	82.4
STANDARD APPROVAL	Stand-by (Watts)	< 0.5		
	Safety	UL		
	Environment Etc.	FCC		
UPC	719192918467	719192918450	719192918443	

PARTNERS

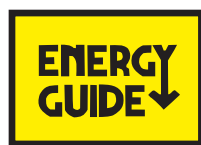

Commercial Grade Stand

The estimated annual energy cost determined in accordance with 16 CFR Part 305.5 for model 43UW660H, 49UW660H, and 55UW660H are \$12, \$15, and \$18 respectively.

"Your energy cost depends on your utility rates and use. The estimated cost is based on 12 cents per kWh and 5 hours of use per day. For more information, visit www.ftc.gov/energy/

FTC Television labeling rule (18 CFR Part 305, as added by 76 Fed. Reg. 1038 (Jan 6, 2011)).



Download LG Commercial Display Mobile App



More info www.LG.com/us/commercial

YouTube youtube.com/c/LGCommercialDisplay

All screen images are simulated. Dimension and weights are approximate. Design, features and specifications subject to change without notice. © Copyright 2016 LG Electronics Inc. All Rights Reserved. Pro:Centric, the "LG" logo, XD Engine are registered trademarks or trademarks of LG Electronics Inc. Pro:Idiom is a registered trademark of Zenith Electronics LLC. All other trademarks or registered trademarks are the property of their respective owners.

